

# EFFECTS AND MECHANISM OF ACUPUNCTURE BASED ON THE PRINCIPLE OF MERIDIANS

GUEST EDITORS: WEI-BO ZHANG, ANDREW WU, GERHARD LITSCHER, AND YOUNBYOUNG CHAE

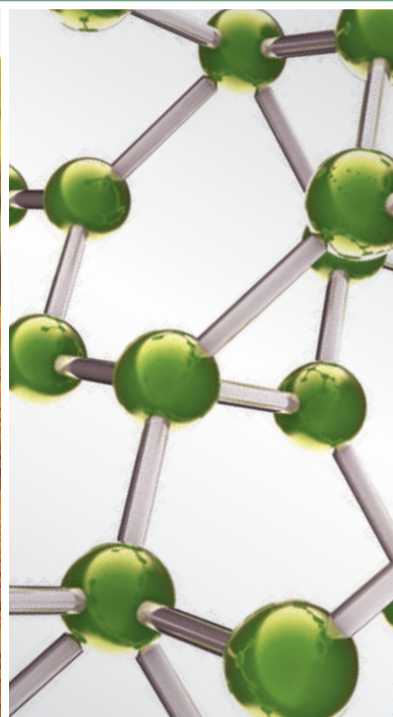

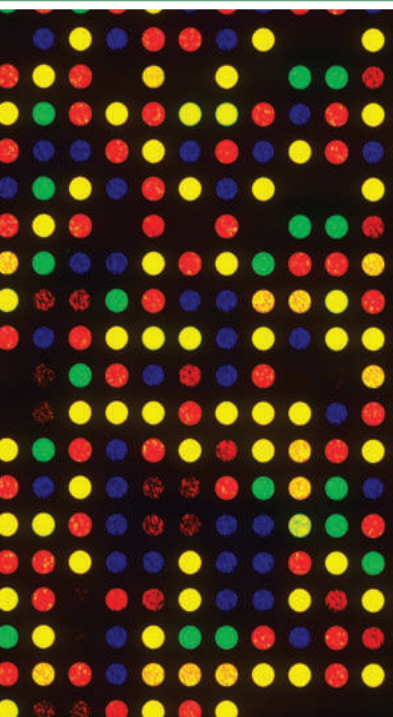

---

# **Effects and Mechanism of Acupuncture Based on the Principle of Meridians**

Evidence-Based Complementary  
and Alternative Medicine

---

## **Effects and Mechanism of Acupuncture Based on the Principle of Meridians**

Guest Editors: Wei-Bo Zhang, Andrew Wu, Gerhard Litscher,  
and Younbyoung Chae



---

Copyright © 2013 Hindawi Publishing Corporation. All rights reserved.

This is a special issue published in "Evidence-Based Complementary and Alternative Medicine." All articles are open access articles distributed under the Creative Commons Attribution License, which permits unrestricted use, distribution, and reproduction in any medium, provided the original work is properly cited.

## Editorial Board

Mahmood Abdulla, Malaysia  
Jon Adams, Australia  
Zuraini Ahmad, Malaysia  
Ulysses Albuquerque, Brazil  
Gianni Allais, Italy  
Terje Alraek, Norway  
Souliman Amrani, Morocco  
Akshay Anand, India  
Shrikant Anant, USA  
Manuel Arroyo-Morales, Spain  
Syed Asdaq, Saudi Arabia  
Seddigheh Asgary, Iran  
Hyunsu Bae, Republic of Korea  
Lijun Bai, China  
Sandip K. Bandyopadhyay, India  
Sarang Bani, India  
Vassya Bankova, Bulgaria  
Winfried Banzer, Germany  
Vernon A. Barnes, USA  
Samra Bashir, Pakistan  
Jairo Kenupp Bastos, Brazil  
Sujit Basu, USA  
David Baxter, New Zealand  
Andre-Michael Beer, Germany  
Alvin J. Beitz, USA  
Yong Boo, Republic of Korea  
Francesca Borrelli, Italy  
Gloria Brusotti, Italy  
Ishfaq A. Bukhari, Pakistan  
Arndt Büssing, Germany  
Rainer W. Bussmann, USA  
Raffaele Capasso, Italy  
Opher Caspi, Israel  
Han Chae, Korea  
Shun-Wan Chan, Hong Kong  
Il-Moo Chang, Republic of Korea  
Rajnish Chaturvedi, India  
Chun Tao Che, USA  
Hubiao Chen, Hong Kong  
Jian-Guo Chen, China  
Kevin Chen, USA  
Tzeng-Ji Chen, Taiwan  
Yunfei Chen, China  
Juei-Tang Cheng, Taiwan  
Evan Paul Cherniack, USA

Jen-Hwey Chiu, Taiwan  
William C. S. Cho, Hong Kong  
Jae Youl Cho, Korea  
Seung-Hun Cho, Republic of Korea  
Chee Yan Choo, Malaysia  
Ryowon Choue, Republic of Korea  
Shuang-En Chuang, Taiwan  
Joo-Ho Chung, Republic of Korea  
Edwin L. Cooper, USA  
Gregory D. Cramer, USA  
Meng Cui, China  
Roberto Cuman, Brazil  
Vincenzo De Feo, Italy  
Rocío Vázquez, Spain  
Martin Descarreaux, USA  
Alexandra Deters, Germany  
Siva Durairajan, Hong Kong  
Mohamed Eddouks, Morocco  
Thomas Efferth, Germany  
Tobias Esch, Germany  
Saeed Esmaeili-Mahani, Iran  
Nianping Feng, China  
Yibin Feng, Hong Kong  
Josue Fernandez-Carnero, Spain  
Juliano Ferreira, Brazil  
Fabio Firenzuoli, Italy  
Peter Fisher, UK  
W. F. Fong, Hong Kong  
Romain Forestier, France  
Joel J. Gagnier, Canada  
Jian-Li Gao, China  
Gabino Garrido, Chile  
Muhammad Ghayur, Pakistan  
Anwarul Hassan Gilani, Pakistan  
Michael Goldstein, USA  
Mahabir P. Gupta, Panama  
Mitchell Haas, USA  
Svein Haavik, Norway  
Abid Hamid, India  
N. Hanazaki, Brazil  
K. B. Harikumar, India  
Cory S. Harris, Canada  
Thierry Hennebelle, France  
Seung-Heon Hong, Korea  
Markus Horneber, Germany

Ching-Liang Hsieh, Taiwan  
Jing Hu, China  
Gan Siew Hua, Malaysia  
Sheng-Teng Huang, Taiwan  
Benny Tan Kwong Huat, Singapore  
Roman Huber, Germany  
Angelo Antonio Izzo, Italy  
Kong J., USA  
Suresh Jadhav, India  
Kanokwan Jarukamjorn, Thailand  
Yong Jiang, China  
Zheng L. Jiang, China  
Stefanie Joos, Germany  
Sirajudeen K.N.S., Malaysia  
Z. Kain, USA  
Osamu Kanauchi, Japan  
Wenyi Kang, China  
Dae Gill Kang, Republic of Korea  
Shao-Hsuan Kao, Taiwan  
Krishna Kaphle, Nepal  
Kenji Kawakita, Japan  
Jong Yeol Kim, Republic of Korea  
Cheorl-Ho Kim, Republic of Korea  
Youn Chul Kim, Republic of Korea  
Yoshiyuki Kimura, Japan  
Joshua K. Ko, China  
Toshiaki Kogure, Japan  
Nandakumar Krishnadas, India  
Yiu Wa Kwan, Hong Kong  
Kuang Chi Lai, Taiwan  
Ching Lan, Taiwan  
Alfred Längler, Germany  
Lixing Lao, Hong Kong  
Clara Bik-San Lau, Hong Kong  
Jang-Hern Lee, Republic of Korea  
Tat leang Lee, Singapore  
Myeong S. Lee, UK  
Christian Lehmann, Canada  
Marco Leonti, Italy  
Ping-Chung Leung, Hong Kong  
Lawrence Leung, Canada  
Kwok Nam Leung, Hong Kong  
Ping Li, China  
Min Li, China  
Man Li, China

ChunGuang Li, Australia  
Xiu-Min Li, USA  
Shao Li, China  
Yong Hong Liao, China  
Sabina Lim, Korea  
Bi-Fong Lin, Taiwan  
Wen Chuan Lin, China  
Christopher G. Lis, USA  
Gerhard Litscher, Austria  
Ke Liu, China  
I-Min Liu, Taiwan  
Gaofeng Liu, China  
Yijun Liu, USA  
Cun-Zhi Liu, China  
Gail B. Mahady, USA  
Juraj Majtan, Slovakia  
Subhash C. Mandal, India  
Jeanine Marnewick, South Africa  
Virginia S. Martino, Argentina  
James H. McAuley, Australia  
Karin Meissner, USA  
Andreas Michalsen, Germany  
David Mischoulon, USA  
Syam Mohan, Malaysia  
J. Molnar, Hungary  
Valério Monteiro-Neto, Brazil  
H.-I. Moon, Republic of Korea  
Albert Moraska, USA  
Mark Moss, UK  
Yoshiharu Motoo, Japan  
Frauke Musial, Germany  
MinKyun Na, Republic of Korea  
Richard L. Nahin, USA  
Vitaly Napadow, USA  
F. R. F. Nascimento, Brazil  
S. Nayak, Trinidad And Tobago  
Isabella Neri, Italy  
Télesphore Nguelefack, Cameroon  
Martin Offenbacher, Germany  
Ki-Wan Oh, Republic of Korea  
Y. Ohta, Japan  
Olumayokun A. Olajide, UK  
Thomas Ostermann, Germany  
Stacey A. Page, Canada  
Tai-Long Pan, Taiwan  
Bhushan Patwardhan, India  
Berit Smestad Paulsen, Norway  
Andrea Pieroni, Italy  
Richard Pietras, USA  
Waris Qidwai, Pakistan  
Xianqin Qu, Australia  
Cassandra L. Quave, USA  
Roja Rahimi, Iran  
Khalid Rahman, UK  
Cheppail Ramachandran, USA  
Gamal Ramadan, Egypt  
Ke Ren, USA  
Man Hee Rhee, Republic of Korea  
Mee-Ra Rhyu, Republic of Korea  
José Luis Ríos, Spain  
Paolo Roberti di Sarsina, Italy  
Bashar Saad, Palestinian Authority  
Sumaira Sahreen, Pakistan  
Omar Said, Israel  
Luis A. Salazar-Olivo, Mexico  
Mohd. Zaki Salleh, Malaysia  
Andreas Sandner-Kiesling, Austria  
Adair Santos, Brazil  
G. Schmeda-Hirschmann, Chile  
Andrew Scholey, Australia  
Veronique Seidel, UK  
Senthamil R. Selvan, USA  
Tuhinadri Sen, India  
Hongcai Shang, China  
Karen J. Sherman, USA  
Ronald Sherman, USA  
Kuniyoshi Shimizu, Japan  
Kan Shimpo, Japan  
Byung-Cheul Shin, Korea  
Yukihiro Shoyama, Japan  
Chang Gue Son, Korea  
Rachid Soulimani, France  
Didier Stien, France  
Shan-Yu Su, Taiwan  
Mohd Roslan Sulaiman, Malaysia  
Venil N. Sumantran, India  
John R. S. Tabuti, Uganda  
Toku Takahashi, USA  
Rabih Talhouk, Lebanon  
Wen-Fu Tang, China  
Yuping Tang, China  
Lay Kek Teh, Malaysia  
Mayank Thakur, India  
Menaka C. Thounaojam, India  
Mei Tian, China  
Evelin Tiralongo, Australia  
S. C. Tjen-A-Looi, USA  
MichaThl Tomczyk, Poland  
Yao Tong, Hong Kong  
K. V. Trinh, Canada  
Karl Wah-Keung Tsim, Hong Kong  
Volkan Tugcu, Turkey  
Yew-Min Tzeng, Taiwan  
Dawn M. Upchurch, USA  
Maryna Van de Venter, South Africa  
Sandy van Vuuren, South Africa  
Alfredo Vannacci, Italy  
Mani Vasudevan, Malaysia  
Carlo Ventura, Italy  
Wagner Vilegas, Brazil  
Pradeep Visen, Canada  
Aristo Vojdani, USA  
Y. Wang, USA  
Shu-Ming Wang, USA  
Chenchen Wang, USA  
Chong-Zhi Wang, USA  
Kenji Watanabe, Japan  
Jintanaporn Wattanathorn, Thailand  
Wolfgang Weidenhammer, Germany  
Jenny M. Wilkinson, Australia  
Darren Williams, Republic of Korea  
Haruki Yamada, Japan  
Nobuo Yamaguchi, Japan  
Yong-Qing Yang, China  
Junqing Yang, China  
Ling Yang, China  
Eun Jin Yang, Republic of Korea  
Xiufen Yang, China  
Ken Yasukawa, Japan  
Min H. Ye, China  
M. Yoon, Republic of Korea  
Jie Yu, China  
Jin-Lan Zhang, China  
Zunjian Zhang, China  
Wei-bo Zhang, China  
Hong Q. Zhang, Hong Kong  
Boli Zhang, China  
Ruixin Zhang, USA  
Hong Zhang, Sweden  
Haibo Zhu, China

## Contents

**Effects and Mechanism of Acupuncture Based on the Principle of Meridians**, Wei-Bo Zhang, Andrew Wu, Gerhard Litscher, and Younbyoung Chae  
Volume 2013, Article ID 684027, 2 pages

**Observation on Pain Release by Long-Round Needle Therapy in Knee Osteoarthritis Related with Meridian-Sinews Theory**, Yuan-shi Liu, Li-gong Xue, Xiao-jian Ma, and Chun-shan Liu  
Volume 2013, Article ID 781289, 4 pages

**Induction of Hyperalgesia in Pigs through Blocking Low Hydraulic Resistance Channels and Reduction of the Resistance through Acupuncture: A Mechanism of Action of Acupuncture**, Wei-Bo Zhang, Yi-Hui Xu, Yu-Ying Tian, Hong Li, Guang-Jun Wang, Tao Huang, and Shu-Yong Jia  
Volume 2013, Article ID 654645, 9 pages

**Comparison of Acupuncture Effect on Blood Perfusion between Needling Nonacupoint on Meridian and Needling Nonacupoint off Meridian**, Wei-Bo Zhang, Ling-Ling Wang, Heng-Hui Xie, Hong Li, and Yu-Ying Tian  
Volume 2013, Article ID 426052, 6 pages

**Network Analysis of Acupuncture Points Used in the Treatment of Low Back Pain**, Soon-Ho Lee, Chang-Eop Kim, In-Seon Lee, Won-Mo Jung, Hong-Gee Kim, Hyunchul Jang, Sang-Jeong Kim, Hyejung Lee, Hi-Joon Park, and Younbyoung Chae  
Volume 2013, Article ID 402180, 7 pages

**Pathological Changes in Internal Organs after Blocking Low Hydraulic Resistance Channels along the Stomach Meridian in Pigs**, Wen-Ting Zhou, Shu-Yong Jia, Yu-Qing Zhang, Yu-Ying Tian, Guang-Jun Wang, Tao Huang, Li Pang, Yong-Sheng Zhou, Xue-Yan Sun, and Wei-Bo Zhang  
Volume 2013, Article ID 935687, 12 pages

**Study on the Dynamic Compound Structure Composed of Mast Cells, Blood Vessels, and Nerves in Rat Acupoint**, Luo Mingfu, Dong Xiaotong, Song Xiaojing, Jiang Jin, Zhann Jinling, and Han Ying  
Volume 2013, Article ID 160651, 4 pages

**The Impacts of Along-Channel Acupuncture on the Protein Expressions of the Chloride Channel of the Rats with Myocardial Ischemia**, Ze-Dong Cheng, Chun-Ri Li, Xiao-Jiao Shao, Pei-Jing Rong, Xiao-Qing Zhang, Fan-Rong Liang, Yuan Li, and Yi-Guo Chen  
Volume 2013, Article ID 321067, 6 pages

**Evaluating Meridian-Sinew Release Therapy for the Treatment of Knee Osteoarthritis**, Song Wei, Zhi-Huang Chen, Wei-Feng Sun, Geng-Peng Zhang, Xiao-Hao Li, Chun-Fu Hou, Liu-Dan Lu, and Lu Zhang  
Volume 2013, Article ID 182528, 9 pages

**Acupuncture Activates ERK-CREB Pathway in Rats Exposed to Chronic Unpredictable Mild Stress**, Jun Lu, Jia Liang, Jun-Ren Wang, Li Hu, Ya Tu, and Jian-You Guo  
Volume 2013, Article ID 469765, 7 pages

**Visualization of the Meridian System Based on Biomedical Information about Acupuncture Treatment**, In-Seon Lee, Soon-Ho Lee, Song-Yi Kim, Hyejung Lee, Hi-Joon Park, and Younbyoung Chae  
Volume 2013, Article ID 872142, 5 pages

**Simple Acupoints Prescription Flow Chart Based on Meridian Theory: A Retrospective Study in 102 Dogs**, Jong-Ho Jeong, Joo-Young Song, Hyo-Gwon Jo, Ji-Min Kim, Samuel-S. Yoon, Chul Park, Seunghyun Kim, Seong-Soo Roh, Bong Hyo Lee, Chae Ha Yang, and Hee Young Kim  
Volume 2013, Article ID 129315, 13 pages

**Effect of Siguan Acupuncture on Gastrointestinal Motility: A Randomized, Sham-Controlled, Crossover Trial**, Kyung-Min Shin, Ji-Eun Park, Sanghun Lee, Sun-Mi Choi, Yo-Chan Ahn, Jin-Woo Lee, Jin-Hee Kim, and Chang-Gue Son  
Volume 2013, Article ID 918392, 7 pages

**Electroacupuncture at Zusanli (ST36) Prevents Intestinal Barrier and Remote Organ Dysfunction following Gut Ischemia through Activating the Cholinergic Anti-Inflammatory-Dependent Mechanism**, Sen Hu, Ming-Hua Du, Hong-Min Luo, Huan Wang, Yi Lv, Li Ma, Zhi-Long Lin, Xian Shi, Ingrid Gaischek, Lu Wang, and Gerhard Litscher  
Volume 2013, Article ID 592127, 10 pages

**Acupressure at the Meridian Acupoint Xiyangguan (GB33) Influences Near-Infrared Spectroscopic Parameters (Regional Oxygen Saturation) in Deeper Tissue of the Knee in Healthy Volunteers**, Gerhard Litscher, Michael Ofner, Wei He, Lu Wang, and Ingrid Gaischek  
Volume 2013, Article ID 370341, 5 pages

**The Influence of Zusanli and Nonmeridian Acupuncture Points on the Survival Rate and Intestinal Tissue Features after Fatal Hemorrhagic Shock in Rats**, Xian Shi, Yuxian Zhong, Jiarui Yao, Sen Hu, Lu Wang, and Gerhard Litscher  
Volume 2013, Article ID 750620, 4 pages



## Editorial

# Effects and Mechanism of Acupuncture Based on the Principle of Meridians

Wei-Bo Zhang,<sup>1</sup> Andrew Wu,<sup>2</sup> Gerhard Litscher,<sup>3</sup> and Younbyoung Chae<sup>4</sup>

<sup>1</sup> China Academy of Chinese Medical Sciences, Beijing 100700, China

<sup>2</sup> Five Branches University, San Jose, CA 95128, USA

<sup>3</sup> Stronach Research Unit for Complementary and Integrative Laser Medicine, Research Unit of Biomedical Engineering in Anesthesia and Intensive Care Medicine, TCM Research Center, Medical University of Graz, 8036 Graz, Austria

<sup>4</sup> Acupuncture and Meridian Science Research Center, College of Korean Medicine, Kyung Hee University, Seoul, Republic of Korea

Correspondence should be addressed to Wei-Bo Zhang; zhangweibo@hotmail.com

Received 8 October 2013; Accepted 8 October 2013

Copyright © 2013 Wei-Bo Zhang et al. This is an open access article distributed under the Creative Commons Attribution License, which permits unrestricted use, distribution, and reproduction in any medium, provided the original work is properly cited.

This special issue concerns acupuncture effects related with meridians. Out of the 34 submitted papers, 15 papers were accepted to be published (acceptance rate of 44.1%). Of the 15 papers, five papers focused on the clinical effects related to meridians. In a study by J.-H. Jeong et al., a simple acupoint flowchart based after meridian theory was used to direct the acupuncture treatment on 102 dogs with various diseases, and good curative effects were achieved in their study that was entitled “*Simple acupoints prescription flowchart based on meridian theory: a retrospective study in 102 dogs.*” Two papers reported on meridian-sinew therapy for knee osteoarthritis. S. Wei et al. observed better results in 90 cases using meridian-sinew release, as compared to normal acupuncture and drug treatments, in their study that was entitled “*Evaluating meridian-sinew release therapy for the treatment of knee osteoarthritis.*” In an RCT study, Y.-S. Liu et al. compared 97 patients treated with long-round needle therapy to 95 control patients treated with drugs and found a better effect from long-round needle treatment both immediately after the treatment and at the 3-month followup. The effect mechanism was analyzed according to the relationship between the meridian sinew and the fluid meridian channels in their study that was entitled “*Observation on pain release by long-round needle therapy in knee osteoarthritis related with meridian-sinews theory.*” S.-H. Lee et al. performed a network analysis of the acupuncture points used in treating low back pain in which modified mutual information value was calculated to illustrate the technique

of acupoint combination in acupuncture treatment in their study that was entitled “*Network analysis of acupuncture points used in the treatment of low back pain.*” I.-S. Lee et al. summarized 37 clinical studies on the treatment of low back pain and found that the most frequently used acupoints were BL23 (51%), BL25 (43%), BL24 (32%), BL40 (32%), BL60 (32%), GB30 (32%), BL26 (28%), BL32 (28%), and GB34 (21%). A visualized meridian chart was drawn based on the data to understand the origin of meridians in their study that was entitled “*Visualization of the meridian system based on biomedical information about acupuncture treatment.*” All of five papers confirmed the importance of meridian theory in clinical acupuncture.

The second group of papers focused on various effects of acupuncture when stimulating acupoints and meridians. W.-B. Zhang et al. found an increase of blood perfusion when needling a point on a meridian but not on an acupoint, as compared to needling a point off meridian but at an acupoint level, which proved the ancient theory that missing a point is less important than missing a meridian in their study that was entitled “*Comparison of acupuncture effect on blood perfusion between needling nonacupoint on meridian and needling nonacupoint off meridian.*” Gerhard Litscher et al. found that, when acupressing Xiyangguan (GB33), the regional oxygen saturation at the deeper knee tissue increased significantly while no considerable change occurred in the opposite control area, implying a meridian-related effect in their study that was entitled “*Acupressure at the meridian*

*acupoint xiyangguan (GB33) influences near-infrared spectroscopic parameters (regional oxygen saturation) in deeper tissue of the knee in healthy volunteers."*

Four papers focused on the mechanism of acupuncture. W.-B. Zhang et al. studied the mechanism of acupuncture in channel dredging. A channel blockage model was made by injecting gel into a low hydraulic resistance channel (LHRC) in minipigs resulting in hyperalgesia. Acupuncture was applied to reduce the hydraulic resistance in the LHRC, which verified the ancient meridian theory that acupuncture can dredge a channel to relieve pain in their study that was entitled "*Induction of hyperalgesia in pigs through blocking low hydraulic resistance channels and reduction of the resistance through acupuncture: a mechanism of action of acupuncture.*" Z.-D. Cheng et al. observed the impact of acupuncture along meridians on the protein expression of chloride channels in myocardial ischemia rats in their study that was entitled "*The impacts of along-channel acupuncture on the protein expressions of the chloride channel of the rats with myocardial ischemia.*" J. Lu et al. reported that acupuncturing Baihui (Du20) and Neiguan (PC6) can increase the ratio of p-ERK1/2 to ERK1/2 and the ratio of p-CREB to CREB at the hippocampus and prefrontal cortex in rats with chronic unpredictable mild stress in their study that was entitled "*Acupuncture activates ERK-CREB pathway in rats exposed to chronic unpredictable mild stress.*" Both studies imply that acupuncture may also influence protein expression. M.-F. Luo et al. observed that recruitment and migration of mast cells along blood vessels and nerves to form a compound structure at acupoint sites after electroacupuncture (EA) were applied, implying that a dynamic compound structure may play an important role in the effect of acupuncture in their study that was entitled "*Study on the dynamic compound structure composed of mast cells, blood vessels, and nerves in rat acupoint.*"

The relationship between meridians and internal organs was addressed in four papers. W.-T. Zhou et al. developed a channel stasis model in minipigs by injecting gel into LHRC of the stomach meridian and found a distension of stomach and intestine after one or two months while no change was observed in control pigs that were injected with saline in their study that was entitled "*Pathological changes in Internal organs after blocking low hydraulic resistance channels along the stomach meridian in pigs.*" S. Hu et al. developed an intestinal barrier injury by ischemic reperfusion. EA was applied at ST36 and nonmeridian points in various conditions. EA at ST36 attenuated the systemic inflammatory response and remote organ injury by protection of the intestinal barrier under the condition of an intact vagus nerve and cholinergic system significantly better than acupuncturing at nonmeridian points in their study that was entitled "*Electroacupuncture at zusanli (ST36) prevents intestinal barrier and remote organ dysfunction following gut ischemia through activating the cholinergic anti-inflammatory-dependent mechanism.*" X. Shi et al. also studied the impact of acupuncture at ST36 and nonmeridian points on rats after a fatal hemorrhagic shock. They found that EA at ST36 significantly improved the blood pressure and increased the early survival rate, as compared to EA at nonmeridian points.

EA can impact internal organs at specific meridian/acupoint sites in their study that was entitled "*The influence of zusanli and nonmeridian acupuncture points on the survival rate and intestinal tissue features after fatal hemorrhagic shock in rats.*" K.-M. Shin et al. studied the effect of acupuncturing Siguan (bilateral LI4 and LR3) on gastrointestinal motility in healthy people after administering mosapride citrate. They found that acupuncturing Siguan can significantly reduce increased gastrointestinal motility, as compared to sham acupuncture in their study that was entitled "*Effect of siguan acupuncture on gastrointestinal motility: a randomized, sham-controlled, crossover trial.*"

In this special issue, we have provided an overview of the majority of studies related to the effects and mechanisms of acupuncture based on principal meridians.

Wei-Bo Zhang  
Andrew Wu  
Gerhard Litscher  
Younbyoung Chae

## Research Article

# Observation on Pain Release by Long-Round Needle Therapy in Knee Osteoarthritis Related with Meridian-Sinews Theory

Yuan-shi Liu,<sup>1</sup> Li-gong Xue,<sup>2</sup> Xiao-jian Ma,<sup>1</sup> and Chun-shan Liu<sup>3</sup>

<sup>1</sup>Guang'anmen Hospital, China Academy of Chinese Medical Sciences, Beijing 100053, China

<sup>2</sup>Institute of Acupuncture and Moxibustion, China Academy of Chinese Medical Sciences, Beijing 100700, China

<sup>3</sup>Shandong Laizhou Maternity and Child Care Hospital, Laizhou 261400, China

Correspondence should be addressed to Li-gong Xue; [dr\\_xlg@yahoo.com.cn](mailto:dr_xlg@yahoo.com.cn)

Received 22 March 2013; Revised 3 June 2013; Accepted 10 June 2013

Academic Editor: Wei-bo Zhang

Copyright © 2013 Yuan-shi Liu et al. This is an open access article distributed under the Creative Commons Attribution License, which permits unrestricted use, distribution, and reproduction in any medium, provided the original work is properly cited.

To evaluate the effectiveness of long-round needle therapy for pain relief in patients with knee osteoarthritis, 192 patients were included in a multicenter, randomized, controlled trial. 97 patients were randomized to the long-round needle therapy group (EG), and 95 patients were randomized to the control group (CG). In EG, the long-round needle therapy was performed once every 7 days for 3 therapy sessions. Ibuprofen sustained-release capsules were administered orally in CG, 1 pill each time, twice daily for 3 weeks. Curative effect was measured after the therapy and was evaluated at a 3-month follow-up interview. In EG, the treatment resulted in a basic cure for 79 patients, was effective for 15 patients, and was ineffective for 1 patient. In CG, the treatment resulted in a basic cure for 30 patients, was effective for 38 patients, and was ineffective for 21 patients. In the follow-up examination in EG, 75 patients were basically cured, and the treatment was effective for 11 patients and ineffective for 9. In CG, 22 were basically cured, 31 found the treatment effective, and 36 found the treatment ineffective. The curative effects in EG after both the treatment and the 3-month followup were significantly more superior than that in CG ( $P < 0.01$ ) which should be adopted more widely.

## 1. Introduction

Knee osteoarthritis (KOA) is prevalent in the elderly population [1]. It is characterized clinically by pain and stiffness, especially when walking up and down stairs, and has a severe, negative impact on quality of life. Pathologically, osteoarthritis is characterized by degeneration of articular cartilage, bone hypertrophy, and subchondral sclerosis [2]. The aim of treatment of KOA is mainly to control symptoms and includes the use of nonsteroidal anti-inflammatory drugs, glucosamine, topical analgesics, intra-articular injection of sodium hyaluronate, and surgical treatment [3]. Many patients find the results of these therapies less than satisfactory; however, more effective treatments have not been developed to date. Since ibuprofen sustained-release capsules (Fenbid) appeared on the market in the 1970s, it has become the drug of choice of KOA [4].

Long-round needle therapy has its roots in the Han Dynasty classic of Chinese medical theory, the Yellow Emperor's Inner Canon, specifically in the "Nine Needles"

chapter [5]. Long-round needle therapy was developed by Xue in 1998 and has since become a popular therapy in China [6, 7]. It is indicated primarily for various types of chronic pain, such as secondary prolapse of lumbar intervertebral disks [8] and shoulder muscle strain [9]. The purpose of this research is to compare the effectiveness of long-round needle therapy and conventional Fenbid for knee osteoarthritis using a multicenter, randomized, controlled trial (RCT) design. Secondly, we hope that this research will contribute to a hypothesis on the mechanism of action of long-round needle therapy based on traditional meridian-sinews theory.

## 2. Objects and Methods

**2.1. Subjects.** 192 patients with KOA were recruited from (1) the out-patient clinic or in-patient department of Institute of Acupuncture and Moxibustion, China Academy of Chinese Medical Sciences; (2) Guang'anmen Hospital, China Academy of Chinese Medical Sciences, or (3) Shandong

Laizhou Maternity and Child Care Hospital. For inclusion, all patients met the following criteria: (1) met the diagnostic criteria of KOA [10, 11], (2) aged 40–65, and (3) signed informed consent. Exclusion was based on the following criteria: (1) did not meet the diagnostic criteria of KOA, (2) serious cardiocerebrovascular system diseases, and (3) unwilling to accept the treatment. Suspension criteria included (1) inability to complete the treatment, (2) not complying with treatment protocols, and (3) serious complications.

**2.2. Data Collection and Test Design.** 192 patients were included in the trial. 97 patients were randomized to the long-needle group (EG), and 85 were randomized to the pharmacotherapy control group (CG). The trial was conducted according to Good Clinical Practice guidelines, and the rights of patients were protected at all times. The study design was a multicenter, randomized, controlled trial. The sample size was calculated based on the effective rate derived from a review of the literature ( $\alpha = 0.05$ ,  $\beta = 0.01$ ). We determined that sample size should be  $n = 192$ , assuming a withdraw rate of 15%, and with a target of 180 patients. Random numbers were acquired from Statistics Analysis System, EG-CG with a 1:1 ratio. The random number table was based on the order in which patients joined the study. The concealment method for the random allocation scheme was the total allocation scheme concealment method, including allocating randomization numbers in order and placing them in opaque envelopes. All 192 patients were randomized to either group EG or CG. The trial began after receiving Ethics Committee approval, and informed consent was obtained from all patients.

### 2.3. Intervention and Methods

**2.3.1. EG.** The needle instrument used was the long-round needle. Sites along the pathways of meridian-sinews were selected for treatment based on traditional diagnostic methods for meridian-sinew disorders. The sites were primarily sites determined to be “knotted,” and needle manipulation was aimed at releasing these knots.

**Site Selection.** Sites along the meridian-sinew of Foot Tai-yang: sub-BL39 (lateral end of the fossa popliteal crease, on the medial border of biceps muscle of the thigh), sub-BL40 (in the middle of the fossa popliteal crease), and sub-BL55 (on the posterior leg, lower point of middle of lower fossa popliteal, and at the level of the inferior border of caput fibulae).

Sites along the meridian-sinew of Foot Shao-yang: intertibiotalar (on the lateral knee, at the joint space of knee), caput fibulae (superior border of caput fibulae), and subtibia (lateral femur, at lateral condyle of femur).

Sites along the meridian-sinew of Foot Yang-ming: lower outer patella (lower outer border of patella), external condyle of tibia (external tuberosity of tibia), lower inner patella (lower inner border of patella, origin of patella medial accessory ligament), inner malleolus condyle of tibia (medial tuberosity of internal epicondyle tibia), and lower patella (lower border of the patella).

Sites along the three Yin meridian-sinews of the foot: upper SP9 (on the medial surface of the leg, at medial surface of the medial condyle of the tibia, and at the level of tubercle of tibia), sub-LR7 (on the medial surface of the leg, at medial border of the medial condyle of the tibia), intercoronary patella (on the lateral knee, in the joint space of the knee), subcoronary crevice (medial surface of the leg, medial surface of the medial condyle of femur), and sub-LR8 (medial knee, superior to the medial condyle of the tibia, and at the bend of gracilis tackle).

**Technique.** Needling techniques for “knot release”:

- (1) Joint puncture: insert needle until the surface of the sinew-knot lesion is reached, then scrape and pluck, moving right to left in order to release superficial adhesions.
- (2) Soothing puncture: insert the needle deeply into the center of adhesions on the sinew-knot lesions located next to tendons. Then slant the tip of the needle upwards, scraping and lifting the adhesions all around it in order to release pressure.

The needling technique employed was chosen based on the location of the meridian-sinew site. Pressure was applied to all sites after needling in order to stop bleeding. To prevent infection, a sterile dressing was applied and left in place for two days.

The therapy above was performed once every 7 days for a total of 3 sessions. Curative effect was measured after the 3 sessions were completed, and long-term results were evaluated with a followup 3 months later.

**2.3.2. CG.** Ibuprofen sustained-release capsules (Fenbid) (0.3 g ibuprofen per pill) were administered orally to patients in CG, 1 pill per dose, twice daily for 3 weeks. Curative effect was measured after 3 weeks, and long-term results were evaluated with a followup 3 months later.

**2.4. KOA Diagnosis and Evaluation of Treatment Results.** KOA diagnosis was based on the *Clinical and Radiological Reference from the American College of Rheumatology* [10]. Guidelines for measuring therapeutic effectiveness were based on the official People’s Republic of China, *Standards for Diagnosis and Therapeutic Effectiveness TCM Patterns and Diseases*, specifically the TCM orthopedics standards for treatment effectiveness for knee osteoarthritis (ZY/T 001.8-94) [11]. Taking into account that the aforementioned standard is not sufficiently quantitative, we introduced therapeutic effectiveness grading and grading index. We developed a KOA treatment observation table to record pain, discomfort, morning stiffness, and walking distance. Discomfort was graded as absent, slight, moderate, or severe and based on the Lequesne evaluation of KOA severity and mobility index. Every item was recorded before treatment. We used the following formula (nimodipine formula):  $n$  (Therapeutic Effectiveness index) =  $[(\text{Grade before treatment} - \text{Grade after treatment}) \div \text{Grade before treatment}] \times 100\%$ . Recover:  $n \geq 90\%$ ; effective:  $n$  is 30%–90%; ineffective:  $n < 30\%$ .

TABLE 1: Data summary for patient numbers in the two groups (EG and CG).

Group	In	Suspended	Removed	Off	Qualified	Rate of qualified (%)
EG	97	0	2	0	95	97.94
CG	95	0	6	0	89	93.68

TABLE 2: Therapeutic effectiveness at end of treatment.

Group	<i>N</i>	Mean	Standard deviation	Median	Minimum	Maximum	<i>t</i>	<i>P</i>
EG	95	47.462	8.116	3.584	1	14	-9.038	0.000
CG	89	38.901	3.214	3.773	0	14		

TABLE 3: Therapeutic effectiveness at followup 3 months after treatment completion.

Group	<i>N</i>	Mean	Standard deviation	Median	Minimum	Maximum	<i>t</i>	<i>P</i>
EG	95	47.462	9.3158	2.34867	-4	14	-10.22	0.000
CG	89	38.901	4.8427	3.50940	-4	12		

**2.5. Statistical Analysis.** All analysis was completed by the National Clinical Experimental Center for New Chinese Herbal Drugs (Beijing, GCP center) by researchers who had not taken part in the clinical trial design or research. First, RCDMS was used to enter and lock data. Second, data was transferred to SPSS 11.5 after confirmation. Then, the analysis, including pain grading calculation and therapeutic effectiveness, was performed, and the clinical data was examined separately.  $P < 0.05$  was used as the standard for statistical significance.

### 3. Results

**3.1. Comparison of Basic Data between the Two Groups.** A total of 8 patients were removed from the study for non-compliance. Two patients in the EG were removed because they began the use of medication during the study period, and 6 patients in the CG were removed for taking other pain killers during the study period. There were no suspended cases or off cases in both groups. The rate of loss was less than 20%. The number of patients was adequate for the trial (Table 1). There was no significant differences in sex, age, or duration of illness ( $P > 0.05$ ) between the two groups; therefore, the groups were comparable.

**3.2. Therapeutic Evaluation.** Therapeutic effectiveness at the end of treatment is shown in Table 2. Therapeutic effectiveness 3 months after the completion of treatment is shown in Table 3.

As seen in Table 2,  $t = -9.038$ ,  $P < 0.01$ ; therefore, the difference is significant, and the therapeutic effectiveness of EG is superior to the CG.

As is seen in Table 3,  $t = -10.219$ ,  $P < 0.01$ ; therefore, the difference is significant, and the therapeutic effectiveness of EG is superior to the CG.

### 4. Discussion

The results showed that long-round needle therapy was superior to Fenbid after both a 3-week course of treatment and at 3-month followup.

Osteoarthritis of the knee, known as impediment (*bi*) disease in TCM, is common in the elderly. It is characterized by joint pain and difficulty of movement and may also lead to economic loss and interfere with activities of daily living (ADL). In modern biomedicine, diagnosis is based on X-ray examination confirming cartilage injury (articular cartilage injury, hyperosteoegeny, etc.). The main treatments are prosthetic replacement, cartilage prosthesis, and spur removal. Fenbid is the internationally recognized pain killer most often used in nonoperative treatment. Although it is reasonably effective at relieving pain, many patients find the side effects unacceptable. Therefore, other therapies are urgently needed.

In the authors' opinion, because there is no nociceptive nerve endings in articular cartilage, KOA pain is not caused by articular cartilage injury but is due to meridian-sinew injury. Long-term, repetitive strain causes "knots" in the meridian-sinews, which in turn block the flow of Qi-blood. It is the knot which causes arthralgia at the joint in the elderly. Therefore, it is necessary to choose treatment sites based on traditional syndrome differentiation and to release the knots. If this is done effectively, it can stop pain and help patients avoid surgery [12].

Based on the meridian-sinews theory in the meridian-sinew chapter of the Yellow Emperor's Canon [13], there are 6 meridian-sinews around the knee. They are meridian-sinew of Foot Tai-yang, meridian-sinew of Foot Shao-yang, meridian-sinew of Foot Yang-ming, meridian-sinew of Foot Tai-yin, meridian-sinew of Foot Jue-yin, and meridian-sinew of Foot Shao-yin. The *Spiritual Pivot* section of the Yellow Emperor's Canon contains a detailed description of the distribution and collection of every meridian-sinew around

the knee. These distribution and collection sites correspond to the most common sites of KOA pain.

There is a close relationship between meridian-channels and meridian-sinews. Meridian-channels are the sites of Qi-blood flow, and these channels also exist within meridian-sinews. Any disorder of the meridian-sinews, such as knots or strips, will obstruct the flow of Qi and cause pain. The author applied the long-round needle, which is an innovation based on the description of the long needle and the round needle in the Yellow Emperor's Canon of Internal Medicine [4], and the "knot release" method in the same book. Knot release can reduce fluid pressure and therefore reduce or even eliminate the collection and seepage of fluid and humors. Treating the meridian-sinews can enhance the flow of interstitial fluid along the meridian-channels, thereby improving overall functioning [14], increasing the elimination of toxins, and reducing pain. The comparison in this paper showed that long-round needle therapy was superior to Fenbid for treating the pain of KOA and should therefore be more widely adopted as a treatment.

## References

- [1] J. C. Scott and M. C. Hochberg, "Arthritic and other musculoskeletal diseases," in *Chronic Disease Epidemiology and Control 2nd Edition*, R. C. Brownson, P. L. Reminton, and J. R. Davis, Eds., pp. 465–489, American Public Health Association, Washington, DC, USA, 1993.
- [2] P. Di Cesare, S. Abramson, and J. Samuels, "Pathogenesis of osteoarthritis," in *Kelley's Textbook of Rheumatology*, G. S. Firestein and W. N. Kelley, Eds., pp. 1525–1540, Saunders Elsevier, Philadelphia, Pa, USA, 8th edition, 2009.
- [3] D. T. Felson, R. C. Lawrence, M. C. Hochberg et al., "Osteoarthritis: new insights—part 2: treatment approaches," *Annals of Internal Medicine*, vol. 133, no. 9, pp. 726–737, 2000.
- [4] B. Wang (Tang Dynasty), "Yellow Emperor's Canon of Internal Medicine: Ling Su, Jiu Zhen Shi Er Yuan," Englished by L.S. Wu, Q. Wu, Beijing, China, China Science & Technology Press.
- [5] J. D. Bradley, K. D. Brandt, B. P. Katz, L. A. Kalasinski, and S. I. Ryan, "Comparison of an antiinflammatory dose of ibuprofen, an analgesic dose of ibuprofen, and acetaminophen in the treatment of patients with osteoarthritis of the knee," *New England Journal of Medicine*, vol. 325, no. 2, pp. 87–91, 1991.
- [6] L. G. Xue, "Study on long-needle," *China Journal of Traditional Chinese Medicine and Pharmacy*, no. 4, pp. 75–76, 1998.
- [7] H.-Z. Guan and H.-J. Zhao, "Brief introduction to professor Xue Li-gong's aponeurotic theory and long-round needle therapy," *Chinese Acupuncture & Moxibustion*, vol. 26, no. 4, pp. 297–300, 2006.
- [8] L. G. Xue, H. R. Zhang, C. S. Liu et al., "Therapeutic effect of long-round needle for treatment of pain in 1396 cases of secondary prolapse of lumbar intervertebral disk," *Chinese Acupuncture & Moxibustion*, vol. 24, no. 9, pp. 637–638, 2004.
- [9] H. Z. Guan and L. G. Xue, "Treatment on shoulder muscle strain by long-round needle," *Chinese Acupuncture & Moxibustion*, vol. 25, no. 12, pp. 869–869, 2005.
- [10] G. Y. Shi, "Meeting summary of the first national conference of osteoarthritis," *Chinese Journal of Rheumatology*, vol. 1, no. 1, pp. 7–9, 1997.
- [11] National Administration of Traditional Chinese Medicine of China, "Standard for Diagnostic and Therapeutic Effectiveness of Syndrome in TCM," Nanjing University Press, 1994.
- [12] B.-Q. Dong, C.-R. Li, F.-Y. Huang, S.-J. Zhang, and L.-G. Xue, "Study on origin of meridians and collaterals through pain relieving effect of muscle regions," *Chinese Acupuncture & Moxibustion*, vol. 31, no. 8, pp. 711–713, 2011.
- [13] B. Wang (Tang Dynasty), "Yellow Emperor's Canon of Internal Medicine: Ling Su, Jing jin," Beijing, China, China Science & Technology Press, 1997.
- [14] W.-B. Zhang, Y.-Y. Tian, H. Li et al., "A discovery of low hydraulic resistance channel along meridians," *Journal of Acupuncture and Meridian Studies*, vol. 1, no. 1, pp. 20–28, 2008.

## Research Article

# Induction of Hyperalgesia in Pigs through Blocking Low Hydraulic Resistance Channels and Reduction of the Resistance through Acupuncture: A Mechanism of Action of Acupuncture

Wei-Bo Zhang,<sup>1</sup> Yi-Hui Xu,<sup>1,2</sup> Yu-Ying Tian,<sup>1</sup> Hong Li,<sup>1</sup> Guang-Jun Wang,<sup>1</sup>  
Tao Huang,<sup>1</sup> and Shu-Yong Jia<sup>1</sup>

<sup>1</sup> Institute of Acupuncture & Moxibustion, China Academy of Chinese Medical Sciences, Beijing 100700, China

<sup>2</sup> Department of Geriatrics, First People's Hospital, Kunshan 215300, China

Correspondence should be addressed to Wei-Bo Zhang; zhangweibo@hotmail.com

Received 31 March 2013; Revised 23 May 2013; Accepted 19 June 2013

Academic Editor: Younbyoung Chae

Copyright © 2013 Wei-Bo Zhang et al. This is an open access article distributed under the Creative Commons Attribution License, which permits unrestricted use, distribution, and reproduction in any medium, provided the original work is properly cited.

According to the classic theory of Chinese medicine, pain is due to the blockage in meridian channels, and acupuncture was invented to treat pain by “dredging” the channels. To test the theory, a hyperalgesia model was made by injecting hydrogel into low hydraulic resistance channel (LHRC) in 12 anaesthetized minipigs. Tail-flick threshold and ear-flick threshold were measured using a thermal radiation dolorimeter, and relative flick threshold (RFT) was calculated. Hydraulic resistance (HR) was measured with a biological HR measuring instrument on low HR points on LHRC and on control points with higher HR located outside LHRC; readings were recorded before, during, and after acupuncture treatment. RFT decreased after blocking the LRHC and was still significantly decreased 2 days and 4 days afterwards. No significant changes occurred when injecting saline into the same points or injecting gel into points outside the channel. Subsequent acupuncture reduced HR on LRHC along meridians but had no significant effect on sites with higher HR located outside LHRC. One of the mechanisms of action of acupuncture treatment for chronic pain may be that acupuncture affects peripheral tissue by reducing the HR in LHRC along meridians, improving the flow of interstitial fluid and removing algogenic substances and thereby relieving pain.

## 1. Introduction and Background

*1.1. The Concept of Pain and Its Treatment Based on Meridian Channels in the Han Dynasty Classic, The Yellow Emperor's Inner Canon.* According to *The Yellow Emperor's Inner Canon*, compiled between 206 BCE and 220 CE, there are meridians and collaterals in the human body constituting a network of channels through which *qi* and *blood* flow. Diseases, such as pain, are caused by *qi* stagnation or *blood* stasis of the channels which slows down the flow of *qi* and *blood*. Acupuncture was invented to treat diseases by inserting a fine needle into the skin at designated points (acupuncture points) and often replaced herbal medicine or puncturing and scraping with *Bian*-stones. Acupuncture regulates *qi* and *blood*, promotes the circulation of *qi* and *blood*, and harmonizes and adjusts healthy and pathogenic *qi* in the channels [1]. How should we understand this theory? Is it actually describing reality or is it just a metaphor? A recent

meta-analysis showed that acupuncture can effectively relieve chronic pain [2]. If such curative effects could be adequately explained by modern medical science, we would not need to consider the existence of meridian channels. Let us consider some of these possible explanations.

Neural mechanisms are a popular explanation for why acupuncture seems to be effective for treating pain. Zhang put forward a hypothesis based on neural interactive mechanisms in the thalamus to explain the pain treatment [4]. Han found that the role of endorphins was a key in acupuncture analgesia [3]. However, neither of these neural mechanisms can sufficiently explain some features of chronic pain and its treatment [5].

It is now relatively well accepted that the treatment of pain with acupuncture can be explained through gate control theory, as developed by Melzack and Wall in 1965 [6]. According to this theory, acupuncture signals are transmitted

through types II and III nerve fibers, which accounts for the sensations of aching, numbness, distension, and heaviness reported by patients. The signals can inhibit the input of pain signals which are primarily transmitted through type IV nerve fibers ( $A_{\delta}$  and C fibers specifically). This explanation works well when applied to acupuncture anaesthesia during surgery, but it is not sufficient to explain why chronic pain can be inhibited not only during an acupuncture session, but also for hours and days afterwards, when gate control signals clearly no longer exist. The meta-analyses by Hopton and MacPherson showed that real acupuncture is significantly more effective for knee pain and tension-type headache in terms of long-term outcomes (6 to 12 months) compared to sham acupuncture [2]. The fact that acupuncture at points distal to the site of pain has also been shown to effectively treat chronic pain, such as heel pain [7], trigeminal neuralgia [8], and scapulohumeral periarthritis [9], is further evidence of the inadequacy of gate control theory as an explanation.

Acupuncture sensation (Deqi) is quite important for treating some conditions, but is not necessary for all acupuncture therapies. For example, shallow acupuncture, in which the stimulation is very light and does not produce a Deqi effect, has been shown to be no less effective than deep acupuncture for some diseases [10]. In meridian-sinew therapy, a needle knife is used to separate tissue adhesions to relieve pain. During this procedure local anaesthesia is applied by injecting a small amount of lidocaine into the operating site, thereby blocking any neural signals which might be involved in gate control. Studies have shown that the release of adhesion with the needle knife under local anesthesia has positive effects on stiffness of the knee, motor functions, and pain control [11], none of which can be explained through gate control theory. Another example of "light sensation" acupuncture is abdomen acupuncture which has been shown to have similar rates of effectiveness for treating cervical spondylosis compared with electrical acupuncture [12]. In addition, moxibustion and massage on the meridian channels do not strongly produce Deqi sensations, and yet they still have curative effects. It has been noted that acupuncture is not only a treatment for pain but can also treat or improve many other kinds of pathological conditions. Pain is usually a signal to alert us to a pathological process; therefore, merely inhibiting the pain without treating the underlying condition is not beneficial to our overall health. Therefore acupuncture should not be regarded as merely a unique method of pain inhibition based on the interaction between nerve signals.

Huang, a senior philologist in China, has described acupuncture points as analogous to turning on a switch [13]. According to the *Yellow Emperor's Inner Canon*, acupuncture exerts its effects by opening meridian channels like a switch. Understanding the nature of the meridian channels is essential for carrying out valid, relevant research on acupuncture.

*1.2. Three Stages of Pain Formation and Related Treatments.* At this point, we still do not fully understand how and why acupuncture can effectively treat chronic pain. One of the main reasons is that the phenomena of pain and the

consciousness of pain are very complicated. Pain involves at least three stages: the stimulating source of pain, the transmission of pain signals, and the processing of pain signals in the central nervous system. Gate control is a process of inhibiting pain signals at the third stage, but may also come into play when giving an intervention at the first or second stage. In western medicine, severe pain that does not respond to other treatments may be treated by damaging the afferent nerves to prevent the input of pain signals. However, since pain is an alarm signal indicating a pathological state in the organs or tissue, blocking the input of pain signals or changing the processing of pain signals in the central nerve system can only temporally relieve symptoms. It will not resolve the problem in the organs or tissues, especially since the most common sources of pain are inflammation, tumors, or tissue injuries, which cannot be addressed through the nervous system alone.

*1.3. Biochemicals Produced by Inflammation Are the Primary Causative Factor for Chronic Pain.* In pain is physiology, pain often related to the process of inflammation, during which many chemicals like bradykinin (BK), prostaglandin (PG), 5-HT, substance P (SP), histamine, and so forth are released from the inflammatory site, leading to hyperalgesia and allodynia [14]. Pressing, stretching, or moving the affected area often causes additional pain, often limiting the movements of chronic pain patients. The other important factor in chronic pain is the accumulation of metabolites, leading to excess  $H^+$  and causing hyperalgesia or pain. This happens when someone exercises too much and lactic acid is produced too quickly to be cleaned up by the circulation system. Logically, if the chemicals which induce the pain are eliminated, the pain will be permanently relieved and we can call this "curing the pain" instead of "analgesia." We can draw parallels with aspirin therapy in western medicine, which is used to inhibit the enzymes that make prostaglandins (PG). Acupuncture may treat pain in a similar fashion by cleaning up algogenic substances.

In the theory of TCM, meridian channels are the channels in which *qi* and *blood* flow; therefore if blockage occurs, pain will result. This is quite similar to the processes mentioned earlier. Our hypothesis is that pain or hyperalgesia is caused by meridian channel stasis, leading to an accumulation of metabolites and inflammatory substances in local tissue. Acupuncture works by cleaning up the algogenic substances in local tissue through dredging the meridian channels.

The first author of this paper, Zhang, has recently shown that one important aspect of the physical basis of the meridian channels is low hydraulic resistance channel (LHRC) that exists along meridians and facilitates the flow of interstitial fluid according to Darcy's law [15]. If the channel is blocked, the interstitial flow will be partially interrupted and this, in turn, will cause an accumulation of metabolic and inflammatory substances. Is it possible to induce hyperalgesia or pain by blocking these LHRC? Can acupuncture open the channels by diminishing the stasis, specifically lowering the hydraulic resistance? Two experiments were designed to answer the questions.



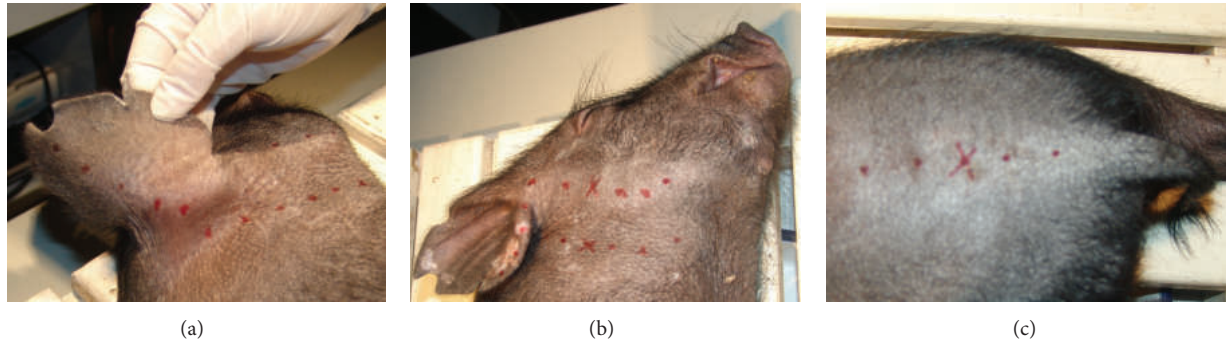

FIGURE 1: (a) A low impedance meridian line propagated along the neck, back of the ear, and the tip of ear (represented by red dots). (b) A low impedance meridian line propagated along the lower jaw and extended to the helix. (c) A low impedance meridian line propagated along the midline of the back and extended to the tail. (× marked the position of low hydraulic resistance points where hydrogel was injected).

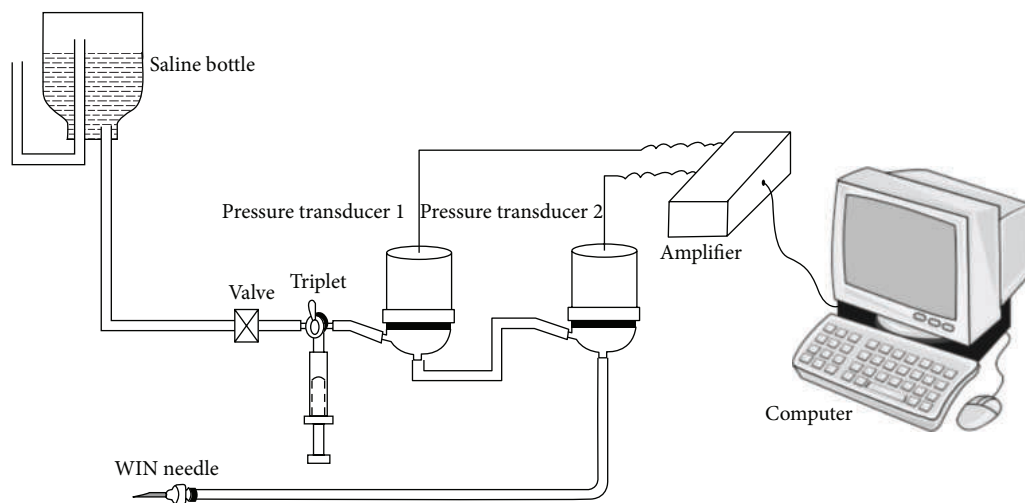

FIGURE 2: The system of measuring hydraulic resistance on subcutaneous tissue in pigs [3].

## 2. Materials and Methods

### 2.1. A Hyperalgesia Model Induced by Injecting Hydrogel into LHRC

**2.1.1. Animal Preparation.** The experiment was carried out on twelve anaesthetized Chinese minipigs (9~11 kg, males, one month of age) which were provided by the Animal Center of Beijing Agriculture University and were kept according to the guidelines issued by Beijing Municipal Administrative Committee for experimental animals. The pigs were forbidden to eat before the operation and were anaesthetized by injecting 1.5 to 2 mg/kg of 2% phenobarbital sodium solution intraperitoneally. After the experiment, the pigs were sent back to the Animal Center to recover for several days until the next experiment.

**2.1.2. Measurement of Meridian Line and Low Hydraulic Resistance Point.** The meridian lines which pass through the ears and tail were measured with an electric impedance meridian locator (type: 57-6F30, made in Donghua factory in China). Two meridian lines were found passing across

the ear. One extended from the tip of the ear, down the back of the ear, and across the neck (Figure 1(a)), following a trajectory similar to the gallbladder meridian. The other went from the helix on the ear to the lower jaw (Figure 1(b)), making it similar to the pathway of the stomach meridian. Another meridian line was found along the midline of pig's back and extended down to the tail (Figure 1(c)), similar to the Governor (*Du*) meridian. The tip of the ear, the helix, and the middle of the tail were chosen to measure pain thresholds.

Low hydraulic resistance points (LHRP) were located by using a biological hydraulic resistance measuring instrument with two pressure transducers in a row (Figure 2, made in Zhang's lab in China) on areas 7~9 cm from the low impedance meridian lines (Figures 1(b) and 1(c)). The principle of measuring LHRP and the calculation of hydraulic resistance was introduced in detail in a previous paper [16].

**2.1.3. Preparation and Injection of Hydrogel.** Polyacrylamide hydrogel was obtained from *Jilin Aodong Biomaterial Company* in China. One gram of pure Polyacrylamide hydrogel was diluted by mixing 5 mL 0.9% saline in order to make it suitable for injection. The 12 pigs were randomly divided

into three groups, with four pigs in each group. In the experimental group, after a LHRP was found, the needle was fixed on the skin with glue and 0.5 mL polyacrylamide hydrogel was slowly injected into the LHRP through the measured needle to block the channel. In the first control group, saline was injected instead of hydrogel but in the same amount and at the same positions. In the second control group, hydrogel was injected at high hydraulic resistance points (HHRP) located 2-3 cm away from LHRC.

**2.1.4. Measurement of Pain Threshold and the Procedure.** A thermal radiation dolorimeter (made by the Institute of Acupuncture in China) with a 0.38 cm<sup>2</sup> hot point and fixed distance of 0.5 cm to the skin was used to measure the pain threshold which was represented by ear-flick threshold and tail-flick threshold, respectively. The instrument has been used in previous studies to measure the tail-flick threshold in rats [17]. The device was never used for more than 15 s in order to prevent tissue damage. The flick thresholds (FT) on the ear tips, the helix on both sides, and the middle of tail, a total of five places, were measured by counting the time between the start of radiation and the flick of the ears or tail with a stopwatch. FT on each place was measured three times with three-minute intervals between the measurements and the average FT was calculated. For each pig, FT was measured before the injection, immediately after the injection, and two days and four days after the injection, respectively. A reference point, at which no injections were given during the time of the experiment, was chosen to eliminate the influence of different anesthesia levels on FT. If FT on the ear tip or helix was used as the site of measurement during the experiment, the middle of the tail was used as a reference. Conversely, if the middle of the tail was used as the site of measurement during the experiment, the ear tip was measured as the reference point.

**2.1.5. Statistics.** The ratio between experimental FT and reference FT was calculated, representing the relative changes of FT (RFT) at the point where the channel was blocked at a distance along the meridian. For each pig, five positions, left ear tip, helix, right ear tip, helix, and tail, were measured. There were 20 measurements in total on the four pigs in each group. One-way ANOVA variance analysis was used to examine the significance of mean RFT following the experiment, and Wilcoxon Signed Ranks Test with 2-tailed analysis was used to examine the mean RFT between the two time points. The level of statistical significance was set at 0.05 for all analyses. Statistical analysis was performed using SPSS 13.0 software.

**2.2. Observing the Change in Hydraulic Resistance along the Channel When Acupuncture Is Performed on Pigs.** The experiment was carried out on three anesthetized minipigs (9~12 kg, males). The animal preparation was the same as in the experiment mentioned in Section 2.1.1. Thirteen meridian lines which were similar to the stomach meridian and gall-bladder meridian were measured by an electric impedance meridian locator (type: 57-6F30, made in Donghua Electric Instrument Factory in China). The LHRPs were located

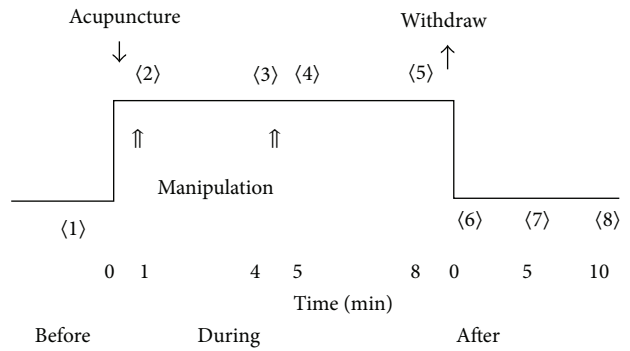

FIGURE 3: Measurement profile of the hydraulic resistance in acupuncture performed on pigs.

using a biological hydraulic resistance measuring instrument (Figure 2) along the low impedance meridian lines. After a LHRP was found, the measuring needle was fixed by glue on the skin for continuous measurement. A point along the meridian line 4~6 cm away from the LHRP was chosen for acupuncture needling. After inserting the acupuncture needle into the skin, manipulation using lift-thrusting and twirling the needle was performed for about one minute, and the needles were retained for 3 minutes. Manipulation was then performed again for one minute, the needles were retained for 3 more minutes, and then the needle was withdrawn. HR was measured before the acupuncture (1), after the first manipulation (2), 3 minutes later (3), after the second manipulation (4), 3 minutes later (5), after withdrawing the needle (6), 5 minutes later (7) and 10 minutes later (8) (Figure 3). Each measurement lasted 6 seconds. For one meridian line, a LHRP and a higher hydraulic resistance point (HHRP) 1-2 cm lateral to the LHRP were measured randomly with the same procedure, and the two measurements were separated by an interval of half an hour to allow for recovery. Statistical analysis was performed as described earlier (Section 2.1.5).

### 3. Results

**3.1. The Hyperalgesia Model.** The average RFTs before injection, immediately after injection, two days after, and four days after the injection are shown in Table 1 and Figure 4 for the three groups.

One-way ANOVA analysis showed a significant decrease of RFT in the LHRP group ( $F_{[3,76]} = 7.977, P = 0.000$ ). No significant differences were found between the group of saline injection ( $F_{[3,76]} = 1.096, P = 0.356$ ) and the group of HHRP injection ( $F_{[3,76]} = 1.232, P = 0.304$ ). In the LHRP group, there were no significant differences between the RFT before and immediately after the injection, while the RFT significantly decreased after 2 days and 4 days compared with the RFT before and immediately after the injection. There was no significant difference in the RFT at 2 days and 4 days after the injection.

**3.2. The Change of Hydraulic Resistance after Acupuncture in Pigs.** The effects of acupuncture on HR were observed on

TABLE 1: The relative flick threshold (RFT) before, immediately after, two days, and four days after the injections in three groups: hydrogel injected into LHRP, saline injected into LHRP, and hydrogel injected into HHRP.

Groups	Before	After	2 days	4 days
LHRP	1.45 ± 0.62	1.22 ± 0.46	0.94 ± 0.31* <sup>Δ</sup>	0.81 ± 0.29* <sup>Δ</sup>
Saline	1.75 ± 1.18	1.44 ± 0.74	1.25 ± 0.60	1.48 ± 0.86
HHRP	1.41 ± 0.95	1.18 ± 0.62	1.53 ± 0.85	1.73 ± 1.02

Means ± SD, n = 20

\* P < 0.05 compared with the value before the injection.

<sup>Δ</sup>P < 0.05 compared with the value immediately after the injection.

TABLE 2: Changes in HR on LHRP and HHRP due to acupuncture needling.

Groups	Before	1' during	4'	5'	8'	0' after	5'	10'
LHRP	47.7 ± 17.7	45.2 ± 16.7	43.5 ± 17.2*	44.0 ± 18.5	40.5 ± 17.2*	42.3 ± 18.4*	38.6 ± 16.8*	38.2 ± 16.4*
HHRP	80.3 ± 12.0	84.2 ± 14.5	84.4 ± 14.1	84.9 ± 13.0*	81.1 ± 14.8	83.3 ± 13.5	79.1 ± 17.3	78.7 ± 18.9

Means ± SD, n = 13

\* P < 0.05 compared with the HR before acupuncture.

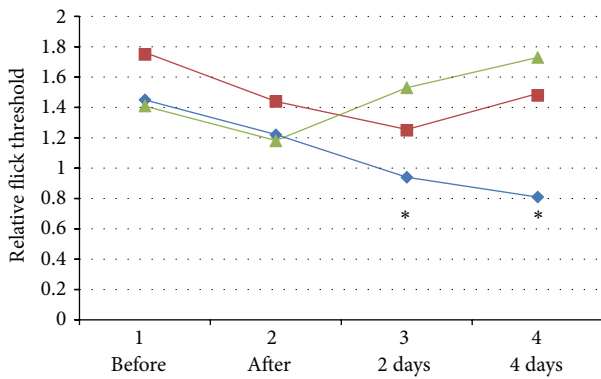

FIGURE 4: The changes in relative flick threshold after injecting hydrogel into LHRP (blue line), injecting saline into LHRP (red line), and injecting hydrogel into HHRP (green line). \* P < 0.05 compared with RFT before the blocking.

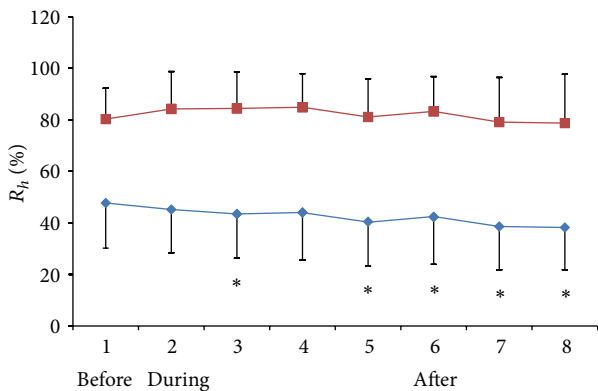

FIGURE 5: The changes of HR on LHRP (blue line) and HHRP (red line) before, during, and after acupuncture in pigs. \* P < 0.05 compared with the HR before acupuncture.

13 low impedance meridian lines. Relative HR ( $R_h\%$ ) was calculated by the formula  $R_h\% = (R_h(p) - R_h(0)) / (R_h(\infty) - R_h(0))$ .  $R_h(\infty)$  is the resistance when the measuring needle is totally closed and  $R_h(0)$  is the resistance when the measuring

needle is totally open. The  $R_h\%$  following each time interval in the LHRP and HHRP groups is shown in Table 2 and Figure 5.

One-way ANOVA analysis showed no significant decrease of HR when measured at the designated time intervals in either of the two control groups ( $F_{[7,96]} = 0.443$ ,  $P = 0.873$  in LHRP;  $F_{[7,96]} = 0.368$ ,  $P = 0.919$  in HHRP). However, at several time points (4' and 8' during the acupuncture and 0', 5', and 10' after withdrawing the needle),  $R_h\%$  was significantly lower than before the acupuncture in the LHRP group, implying a reduction of HR on the LHRC along meridians through acupuncture.

## 4. Discussion

4.1. *The Hyperalgesia Model of Blocking Meridian Channels.* Pain is attributed to stasis or stagnation in meridian channels in classical acupuncture theory, and acupuncture was indicated to dredge the channels in order to relieve pain. This important idea about the mechanism of action of acupuncture had been ignored by modern doctors because neither the true nature of the meridian channels nor the condition of stasis in the meridian channels has been well understood by modern people. Our previous study implied that the true nature of meridian channels is at least partially related to interstitial fluid flow under the conditions of low hydraulic resistance channel along the meridians [15]. This new discovery made it possible to design a study to gauge whether pain appears when the channel is blocked and to determine if acupuncture can alter the condition of the channel. This corresponds quite well to the classic theory.

Polyacrylamide hydrogel was firstly used to treat asynodia in 1983. It has been widely used in cosmetic surgery and breast enhancement, but its safety has not been considered from the perspective of meridian channels, and there were complication reports on long-term use of the material [18]. Polyacrylamide hydrogel was chosen to create stasis in the meridian channels due to the fact that it is already being used as a biological filling material without causing obvious

inflammation over a fourteen-month period [19]. The gel can increase the hydraulic resistance in the meridian channels, stopping the interstitial flow due to the high hydraulic resistance as reported by Scott et al. and Coleman et al. [20, 21]. Our previous study showed that the injection of hydrogel can efficiently block the transmission of interstitial fluid pressure waves when the amount of injection was equal or beyond 0.5 mL [22]. Therefore, 0.5 mL gel was given because this is adequate for blocking but is the least amount possible to minimize the disturbance to the animal.

As pigs cannot report pain themselves, the tail-flick threshold and ear-flick threshold were used to approximately represent the pain threshold which is often applied in animal experiments of pain. Therefore, our model is not exactly a pain model but a hyperalgesia model which involves the same mechanism of pain. The relative flick threshold was used to diminish the possible influence of anaesthesia and to make the results more reliable. As it was rather difficult to test a large number of pigs, unlike rats and rabbits, samples were obtained from different places on each pig and the data was processed using the Wilcoxon Signed Ranks Test.

The results showed a slight decrease of RFT in all three groups immediately after the injection, although it was not significant. The reason for this may be that the injections themselves made pigs more sensitive to the hot stimulation which is in fact not related to the subject injected. Nevertheless, only the injection of hydrogel at LHRP along the channel appeared to produce a progressive hyperalgesia to the stimulation two days after the injection, while no such change occurred in the other two control groups. The results imply that hyperalgesia occurred where the LHRC along meridians was blocked. This could be understood by an accumulation of metabolite containing many  $H^+$  chemicals on LHRC which induces a depolarization of nerve terminals and therefore the process required some time to occur.

How does interstitial fluid flow and what is the function of the flow? Modern physiology focuses on blood flow but few studies have been carried out on interstitial flow. Aukland and Reed discussed the function of interstitial flow on balancing extracellular fluid and preventing edema in 1993 [23]. Swartz and Fleury pointed out in 2007 that interstitial flow affects more than just cell nourishment: it can, for example, induce blood and lymphatic capillary morphogenesis in vitro and lymphatic regeneration in vivo, maintain the functional activity of chondrocytes and osteocytes, drive fibroblast differentiation, and induce cytokine production by smooth muscle cells [24]. If such an important flow is stopped, a pathological state will develop resulting in not only pain but also diminished physiological functions in many areas.

**4.2. The Mechanism of Dredging Meridian Channels through Acupuncture.** If we accept that the true nature of the meridian channels can be understood as low hydraulic resistance channels and the stasis in these channels can be understood as an increase of HR in these channels, then the classic technique of “dredging meridian channels” can be understood as a literal description. From this perspective, acupuncture can be understood as decreasing HR in the meridian channels

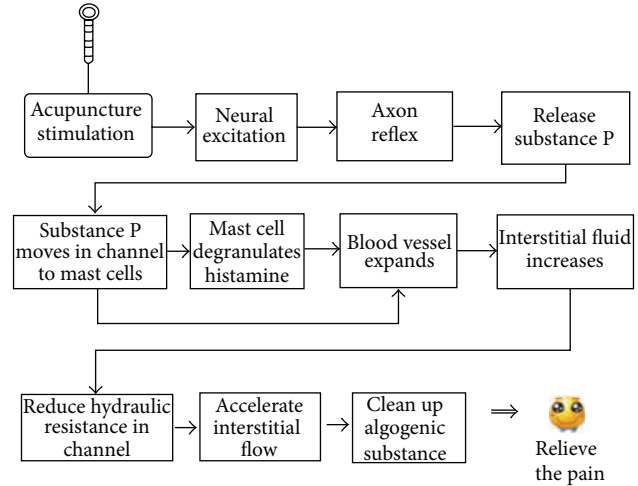

FIGURE 6: A mechanism of action of acupuncture in treating chronic pain.

and restoring the interstitial flow to eliminate wastes from the tissue. Our experiment on the pigs showed a significant decrease of HR in LHRC during and after the acupuncture but no obvious change on the control point outside the channel. The idea of dredging meridian channels as formulated in the *Ling Shu* section of the *Yellow Emperor's Inner Canon* was intended as a general principle for both medical treatment and preventative healthcare. The latter results, taken in combination with the induction of hyperalgesia we have found in the first experiment, suggest a comprehensive explanation for the curative effects of acupuncture for treating chronic pain. Specifically, acupuncture reduces the resistance in the meridian channels and improves interstitial fluid flow, aiding in the elimination of wastes and improving the local internal milieu which eventually leads to the recovery of the normal function of nerve terminals and the reduction of pain. This process also has positive effects on motor and endocrine functions.

The exact mechanism of how acupuncture decreases HR in the meridian channels requires further study in order to be answered. Two mechanisms are involved in the change. One is the pathway related to the blood vessel system. When a needle is inserted into an acupoint, the nerve terminal which usually consists of  $A_\delta$  or C fibers is excited and sends a neural pulse signal to the central nerve system. Then, an axon reflex develops which leads to the release of substance P (SP) and other chemicals into the interstitial fluid around the needle. SP and other signals diffuse and migrate to mast cells nearby through interstitial flow along meridian channels. Mast cells then degranulate and release histamine which will continue to move along meridian channels. SP and histamine can make surrounding blood vessels expand and become more permeable allowing more interstitial fluid to flow outside the vessel. This accelerates the flow along meridian channels and reduces the hydraulic resistance along the channels. The lower resistance further facilitates the interstitial flow which can eliminate algogenic substances to relieve pain (Figure 6).

The release of SP during acupuncture and its influence on neurons across segments have been proven experimentally by Zhang et al. [25, 26]. The degranulation of histamine from mast cells was also proven to play an important role in the analgesic effects of acupuncture [27]. The migration of neurotransmitters and other chemicals in extracellular space was named “volume transmission (VT)” by Agnati et al. in 1986 [28], and VT in peripheral tissue along meridians was discussed recently as an explanation for an important meridian phenomenon: propagated sensation along meridian [29]. The increase of blood perfusion and an increase of interstitial fluid represented by the decrease of electric impedance have been observed by Zhang et al. [30, 31]. The new evidence in this paper seems to indicate that the role of blood is essential in the mechanism of action of acupuncture.

The other pathway might be through the kinetic system. Due to biophysical principles, the activity of muscle will influence the interstitial flow tremendously. A rhythmic contraction can enhance the interstitial flow while a tetanic contraction or atrophy will diminish the flow. Acupuncture can help the muscles return to a normal state due to the kinetic reflex effected through the muscle spindle reflex or the tendon reflex. This regulation can even act on a remote place along meridians through  $\alpha$  motor neuron chains in the spinal cord, as has been found by Xie et al. in 1995 [32]. Myoelectricity during acupuncture has been observed by several researchers [33, 34], and an increase of HR when a tetanic contraction developed has been found in our lab recently [35]. Direct evidence of improving interstitial flow is still absent although there is indirect evidence that acupuncture can accelerate the migration of isotope  $^{99m}\text{TcO}_4^-$  along meridians [36]. More experiments should be undertaken to prove the kinetic mechanism of acupuncture.

Xuan Ze-ren in China developed his theory of aseptic inflammation as the cause of some chronic pain such as lumbar disc herniation [37]. Xuan has applied the special treatment of soft tissue lysis on many cases instead of classic resection of lumbar disc herniation and has reported good results [38, 39]. Acupuncture can facilitate the interstitial flow by reducing the resistance in the channels. Other treatments in TCM may have similar mechanisms. For example, moxibustion enhances the interstitial flow by expanding blood vessels; massage and cupping enhance the interstitial flow by changing interstitial fluid pressure; meridian-sinews release therapy can release the extra interstitial fluid which contains inflammatory substance and reduce abnormally high fluid pressure. According to the terminology of traditional Chinese medicine, acupuncture “dredges” meridian channels, making *qi* and *blood* flow more efficiently so that pain is eliminated. The concept of lowering hydraulic resistance is quite consistent with this classical idea and the relief of pain can be logically conceptualized as the elimination of algogenic substances through stronger interstitial flow induced by lowering the resistance in meridian channels.

*4.3. The Relationship between Acupuncture Effects, Meridian Channels, and the Nervous System.* Longhurst put forward a definition for meridian channels, stating that it is an entity

that, when stimulated by acupuncture, can result in clinical improvement [40]. The mechanism of action of acupuncture on peripheral tissue, in which LHRC plays the key role, fits this definition quite well and does not deny the role of the nervous system. Longhurst also posited out that the peripheral and central nervous systems can now be considered to be the most rational basis for defining meridian channels [40], a view which is held by many other scholars. However, an entity which is related to an acupuncture effect does not mean it is the meridian channel. To determine whether an entity is the meridian channel, several criteria need to be met, including distribution patterns, the function of nourishing tissue, “smoothing joints,” regulating organs and resisting evil. These should be taken into account apart from the acupuncture effect. More essentially, the characteristics of a channel as something that restricts material or energy, runs along a specific route and is in an opened or closed state should be elucidated. We know that the main function of nerves is transporting neural signals, and that they are not responsible for diminishing inflammation, resisting bacteria, healing tissue, and so on. Also, the transportation of neural signals is very fast and difficult to be stopped by mechanical pressure which is not similar to the characteristics of propagated sensation along meridians. Neural excitation is indeed the first step in the cascade of events of the acupuncture effect. But to get a real long-term effect, a permanent change, neural excitation is not enough. There must be a chain of actions to finish the effect. Neural excitation is also not the only pathway for acupuncture effects. Manipulation in acupuncture is an important step to get a good effect but its contribution to neural excitation is small. Langevin et al. found a winding of collagen around acupuncture needle after a manipulation of bidirectional rotation [41]. Ding further found a positive relationship between the twist of collagen, degranulation of mast cell, and acupuncture analgesia [42]. Degranulation of mast cell is a middle step which can be induced not only by axon reflex of neural excitation but also by the shearing motion of collagen during acupuncture manipulation. There are multipathways for the effects of acupuncture. A meridian channel entity should be defined not only by the effects of acupuncture but also should also include other aspects.

## 5. Conclusion

Blocking meridian channels by injecting hydrogel causes a hyperalgesic state. The mechanism of action of acupuncture in treating chronic pain can be understood as a reduction of hydraulic resistance in meridian channels which accelerates interstitial flow, eliminates algogenic substances, and ultimately relieves pain.

## Conflict of Interests

All the authors declare that they have no conflict of interests.

## Acknowledgment

This work was supported by the National Nature Science Foundation of China no. 30572307 and no. 81173206.

## References

- [1] B. Wang, *Yellow Emperor's Canon of Internal Medicine: Ling Su, Jiu Zhen Shi Er Yuan*, English translation by L. S. Wu, Q. Wu, China Science & Technology Press, Beijing, China, 1997.
- [2] A. Hopton and H. MacPherson, "Acupuncture for chronic pain: is acupuncture more than an effective placebo? A systematic review of pooled data from meta-analyses," *Pain Practice*, vol. 10, no. 2, pp. 94–102, 2010.
- [3] J. S. Han, "On the mechanism of acupuncture analgesia," *Acupuncture Research*, vol. 9, no. 3, pp. 231–245, 1984.
- [4] X. Zhang, "The integration on thalamus during acupuncture analgesia," *Science in China A*, vol. 16, no. 1, pp. 28–52, 1973.
- [5] G. Q. Fan, L. L. Qian, Y. Zhao et al., "Acupuncture analgesia: variousness and analysis," *Chinese Acupuncture & Moxibustion*, vol. 33, no. 10, pp. 92–96, 2013.
- [6] R. Melzack and P. D. Wall, "Pain mechanisms: a new theory," *Science*, vol. 150, no. 3699, pp. 971–979, 1965.
- [7] X. M. Zhu and M. Zhang, "Clinical application of acupuncture at distal single point to treatment of painful heels," *World Journal of Acupuncture-Moxibustion*, vol. 22, no. 4, pp. 60–64, 2012.
- [8] B. Feng, "Treating trigeminal neuralgia by acupuncture at distal point," *Journal of Yunnan University of Traditional Chinese Medicine*, vol. 35, no. 6, pp. 41–42, 2012.
- [9] G. S. Chen and W. B. Gao, "Clinical observation on treating scapulohumeral periarthritis by acupuncture at distal point with a movement," *Clinical Journal of Acupuncture*, vol. 27, no. 10, pp. 39–41, 2011.
- [10] X. J. Chang and B. Xu, "Proceeding in the relationship between the depth of acupuncture and effect," *Shanghai Journal of Acupuncture and Moxibustion*, vol. 127, no. 12, pp. 48–50, 2008.
- [11] Z. H. Chen, S. Wei, and W. F. Sun, "Clinical observation of 80 cases of knee osteoarthritis treated with traditional Fascia-meridian scope," *Chinese Journal of Guiyang College of Traditional Chinese Medicine*, vol. 22, no. 5, pp. 56–57, 2011.
- [12] J. F. Xiong, "Treatment on 40 cases of cervical spondylosis of vertebral artery type by abdominal acupuncture with moxibustion on Shenjue," *Journal of External Therapy of Traditional Chinese Medicine*, no. 1, pp. 40–41, 2012.
- [13] L. X. Huang, *Acupuncture: Harmonization in the Music of Life*, People's Medical Publishing House, Beijing, China, 2008.
- [14] Z. Q. Zhao, *Spinal Mechanism Underlying Pain*. Shanghai, Science and Education Press, Shanghai, China, 2000.
- [15] W.-B. Zhang, Y.-Y. Tian, H. Li et al., "A discovery of low hydraulic resistance channel along meridians," *JAMS Journal of Acupuncture and Meridian Studies*, vol. 1, no. 1, pp. 20–28, 2008.
- [16] W. B. Zhang, Y. Y. Tian, and H. Li, "A method to measure hydraulic resistance of subcutis continuously and the study of low hydraulic resistance points(Chin)," *ACTA Biophysica Sinica*, vol. 14, no. 2, pp. 373–379, 1998.
- [17] Z. Q. Chen, W. Xu, Y. S. Yan, and K. Y. Chen, "The influence of acupuncture manipulation of "Xuji" reinforcing-reducing to the tail-flick threshold, vocalization threshold and skin temperature in rats," *Chinese Acupuncture & Moxibustion*, no. 4, pp. 38–40, 1988.
- [18] T. Wu, X. M. Luo, B. Wang et al., "Systematic review of follow-up study of hydrophilic polyacrylamid gel injection for soft tissue filling," *Journal of Pharmacovigilance*, vol. 3, no. 2, pp. 93–97, 2006.
- [19] P. S. Yan, K.-H. Lu, W. Yan et al., "The pathologic and immunohistochemical changes of rabbit injected with polyacrylamid hydrogel," *Chinese Journal of Aesthetic and Plastic Surgery*, vol. 17, no. 5, pp. 395–398, 2006.
- [20] D. Scott, P. J. Coleman, R. M. Mason, and J. R. Levick, "Glycosaminoglycan depletion greatly raises the hydraulic permeability of rabbit joint synovial lining," *Experimental Physiology*, vol. 82, no. 3, pp. 603–606, 1997.
- [21] P. J. Coleman, D. Scott, A. Abiona, D. E. Ashhurst, R. M. Mason, and J. R. Levick, "Effect of depletion of interstitial hyaluronan on hydraulic conductance in rabbit knee synovium," *Journal of Physiology*, vol. 509, no. 3, pp. 695–710, 1998.
- [22] Y. H. Xu, W. B. Zhang, Y. Y. Tian et al., "Preliminary observation of the blocking effect produced by injecting polyacrylamide hydrogel on low hydraulic resistance channel along meridian," *Journal of Biomedical Engineering*, vol. 26, no. 4, pp. 776–779, 2009.
- [23] K. Aukland and R. K. Reed, "Interstitial-lymphatic mechanisms in the control of extracellular fluid volume," *Physiological Reviews*, vol. 73, no. 1, pp. 1–78, 1993.
- [24] M. A. Swartz and M. E. Fleury, "Interstitial flow and its effects in soft tissues," *Annual Review of Biomedical Engineering*, vol. 9, pp. 229–256, 2007.
- [25] S.-H. Zhang, Q.-X. Sun, Z. Seltzer et al., "Paracrine-like excitation of low-threshold mechanoreceptive C-fibers innervating rat hairy skin is mediated by substance P via NK-1 receptors," *Brain Research Bulletin*, vol. 75, no. 1, pp. 138–145, 2008.
- [26] Q. Zhang, Y. Zhao, Y. Guo et al., "Electrophysiological evidence for the interaction of substance P and glutamate on A $\delta$  and C afferent fibre activity in rat hairy skin," *Clinical and Experimental Pharmacology and Physiology*, vol. 33, no. 12, pp. 1128–1133, 2006.
- [27] D. Zhang, G.-H. Ding, X.-Y. Shen et al., "Influence of mast cell function on the analgesic effect of acupuncture of "Zusanli" (ST 36) in rats," *Acupuncture Research*, vol. 32, no. 3, pp. 147–152, 2007.
- [28] L. F. Agnati, K. Fuxe, and M. Zoli, "A correlation analysis of the regional distribution of central enkephalin and  $\beta$ -endorphin immunoreactive terminals and of opiate receptors in adult and old male rats. Evidence for the existence of two main types of communication in the central nervous system: the volume transmission and the wiring transmission," *Acta Physiologica Scandinavica*, vol. 128, no. 2, pp. 201–207, 1986.
- [29] W. B. Zhang, Y. Zhao, and K. Fuxe, "Understanding propagated sensation along meridians by volume transmission in peripheral tissue," *Chinese Journal of Integrative Medicine*, vol. 19, no. 5, pp. 330–339, 2013.
- [30] W.-B. Zhang, L.-L. Wang, T. Huang et al., "Laser Doppler perfusion imaging for assessment of skin blood perfusion after acupuncture," *Medical Acupuncture*, vol. 20, no. 2, pp. 109–118, 2008.
- [31] W. Zhang, R. Xu, and Z. Zhu, "The influence of acupuncture on the impedance measured by four electrodes on meridians," *Acupuncture and Electro-Therapeutics Research*, vol. 24, no. 3–4, pp. 181–188, 1999.
- [32] Y. K. Xie, H. Q. Li, and W. H. Xiao, "Neurobiological study on meridians and propagated sensation along meridians," *Science in China B*, vol. 25, no. 7, pp. 721–731, 1995.
- [33] C. Ma, Z. Zheng, and Y. K. Xie, "Reflex activity of myoelectricity on longissimus dorsi muscle during propagated sensation along meridians," *Chinese Sciences Bulletin*, vol. 45, no. 18, pp. 1982–1988, 2000.
- [34] B. Zhu, P. J. Rong, Y. Q. Li et al., "Myoelectricity along meridians and propagated sensation along meridians," *Science in China C*, vol. 31, no. 5, pp. 465–470, 2001.

- [35] S. Y. Jia, Y. Y. Tian, G. J. Wang et al., "The influence of muscle contraction to the hydraulic resistance of low hydraulic resistance channel along meridians in mini-pigs," *Journal of Traditional Chinese Medicine*, vol. 18, no. 7, pp. 764–765, 2012.
- [36] R. W. Li, B. Q. Chang, C. Wen et al., "The influence of acupuncture to the migration of radionuclide along meridians," *Acupunct Res*, no. S4, pp. 50–53, 1989.
- [37] Z. R. Xuan, *Xuan Zhe-Ren's Surgery in Soft Tissue*, Wenhui, Shanghai, China, 2002.
- [38] Q. M. Wang, "The results of surgery treatment for lumbar disc protrusion and spinal canal stenosis(A Report of 580 Cases)," *he Journal of Cervicodynia and Lumbodynia*, vol. 17, no. 3, pp. 148–150, 1996.
- [39] L. Z. Sun, "Observation on treating 64 cases of chronic pain at low back and leg by soft tissue lysis," *Jiangxi Journal of Traditional Chinese Medicine*, no. S2, p. 95, 1996.
- [40] J. C. Longhurst, "Defining meridians: a modern basis of understanding," *JAMS Journal of Acupuncture and Meridian Studies*, vol. 3, no. 2, pp. 67–74, 2010.
- [41] H. M. Langevin, D. L. Churchill, J. R. Fox, G. J. Badger, B. S. Garra, and M. H. Krag, "Biomechanical response to acupuncture needling in humans," *Journal of Applied Physiology*, vol. 91, no. 6, pp. 2471–2478, 2001.
- [42] X.-J. Yu, G.-H. Ding, W. Yao, R. Zhan, and M. Huang, "The role of collagen fiber in "Zusanli" (ST 36) in acupuncture analgesia in the rat," *Chinese Acupuncture & Moxibustion*, vol. 28, no. 3, pp. 207–213, 2008.

## Research Article

# Comparison of Acupuncture Effect on Blood Perfusion between Needling Nonacupoint on Meridian and Needling Nonacupoint off Meridian

Wei-Bo Zhang,<sup>1</sup> Ling-Ling Wang,<sup>1,2</sup> Heng-Hui Xie,<sup>1,3</sup> Hong Li,<sup>1</sup> and Yu-Ying Tian<sup>1</sup>

<sup>1</sup> Institute of Acupuncture & Moxibustion, China Academy of Chinese Medical Sciences, Beijing 100700, China

<sup>2</sup> Liulitun Community Health Centre, Chaoyang District, Beijing 100026, China

<sup>3</sup> Beijing Chaoyang Hospital, Beijing 100020, China

Correspondence should be addressed to Wei-Bo Zhang; zhangweibo@hotmail.com

Received 25 April 2013; Accepted 18 June 2013

Academic Editor: Gerhard Litscher

Copyright © 2013 Wei-Bo Zhang et al. This is an open access article distributed under the Creative Commons Attribution License, which permits unrestricted use, distribution, and reproduction in any medium, provided the original work is properly cited.

To verify the ancient theory of rather missing the acupoint than missing the meridian, acupuncture at nonacupoint on meridian and acupuncture at nonacupoint off meridian were performed, respectively. The blood perfusion (BP) on the calf around bladder meridian area was measured with a laser Doppler perfusion imager before, during, and after acupuncture. The whole scanning field was divided into seven subareas, and mean BP on each area was calculated. The ratio of mean BP between a subarea and a reference subarea was gotten, and then the change rate was calculated as ratio change rate (RCR). The results showed that RCR on bladder meridian area and around Chengshan (BL57) during or after acupuncture at nonacupoint on meridian was significantly higher than that at nonacupoint off meridian, which supports the ancient theory. Such differences may be attributable to some factors that can facilitate the signals transmission and produce a better acupuncture effect, such as richer nerve terminals, blood vessels, and mast cells which can produce stronger signals on the acupoints and the low hydraulic resistance channel along meridians which plays a role of signal transmitting channel to get a better effect of acupuncture.

## 1. Introduction

The ancient theory of “rather missing the acupoint than missing the meridian” is an important principle to guide the acupuncture clinic originated from Yang’s “Compendium of Acupuncture and Moxibustion” in *Ming* dynasty [1]. In locating acupoints, patient’s fingers are often used as a ruler, and *cun* serves as unit of length for measurement which is called finger *cun*. For instance, the length between the two medial ends of the twisted folds of the middle finger when bent, or the width of the phalangeal joint of the thumb is taken as 1 *cun*, and the maximal width of the four fingers (viz., the first finger, middle finger, ring finger, and little finger) held together with the hand open is taken as a unit of measurement of 3 *cun*. But in acupuncture clinic, locating of acupoints with patient’s finger is not convenient and often replaced by acupuncturist’s finger which is easy to miss the right position as the *cun* from the acupuncturist is often different

from the “*cun*” from the patient. In addition, locating of the acupoint on meridian is also conducted by anatomic signs or by the patient’s feeling when pressing the specific place on body surface with a finger. Thus, it is possible to miss acupoints or miss meridians during the locating. The ancient theory of “rather missing the acupoint than missing the meridian” implies a possibility that the effect of acupuncture at the nonacupoint on the meridian is superior to that of acupuncture at nonacupoint off the meridian.

Acupuncture effect was represented partly by blood perfusion (BP) or blood flow (BF) in several experiments [2–7]. The imaging technique which can measure BP level on skin has been used in evaluating the efficiency of acupuncture. It has great advantages of being objective and having ability of measuring BP level on different parts of body surface. By this technique, we have observed the effect of acupuncture at Hegu (LI 4) and found three different effects such as local effect, holistic effect, and meridian effect which is important



to understanding of the relationship between acupuncture and meridians [4]. This study was undertaken to compare the effects of acupuncture at nonacupoint on the meridian and acupuncture at nonacupoint off the meridian to examine the ancient theory of “rather missing the acupoint than missing the meridian.”

## 2. Materials and Methods

**2.1. Subjects.** 20 healthy volunteers were from China Academy of Chinese Medical Sciences and Beijing University of Chinese Medicine. Of them, 11 were male and 9 female, ranging in age from 19 to 55 years. They had no illnesses or obvious discomfort within a week and had not taken medicine in the past one month before the test. All the participants had an adequate understanding of the procedure and purpose of this trial.

**2.2. Instruments and Environment.** The BP on the skin of calf around bladder meridian area was measured by a PeriScan PIM II laser Doppler perfusion imager (made in Sweden). The instrument was set to medium resolution and  $50 \times 64$  (3200) points. The scan area was about  $15 \times 20$  cm and each scan took about 3 minutes. The acupuncture needle of  $0.30 \times 30$  mm (Huan Qiu, Suzhou, China) was used in this test. The test was carried out in a dark room. The room temperature was kept between  $26$  and  $28^\circ\text{C}$ . The fluctuation in the temperature was less than  $\pm 1^\circ\text{C}$  during one experiment.

**2.3. Experimental Procedure.** Each subject received twice measurements with an interval of more than two days between the two measurements and chose to acupuncture at nonacupoint on the meridian first or at nonacupoint off the meridian first at random. Before the measurement, subject was asked to lie on bed for ten minutes to adapt to the room temperature. Measuring of BP before acupuncture was given for one time and then the acupuncture was started.

Acupuncture was performed at two selected points. One point was located on 2 cm above Chengshan (BL57), on Bladder Meridian of Foot Taiyang, as nonacupoint on the meridian, and the other point on Chengshan (BL 57) level, 2 cm lateral to Bladder Meridian of Foot Taiyang, as nonacupoint off the meridian (Figure 1). One of the two points was acupunctured first. The needle was inserted into 0.5 to 1.0 cun depth that is the standard depth of Chengshan (BL 57), and uniform reinforcing-reducing manipulation was applied for about one minute to induce needling reaction as much as possible. After obtainment of needling reaction, the needle was remained. During the needle retention period, the BP was continuously measured for five times, which took totally about 20 minutes. And then, the needle was withdrawn. After withdrawal of the needle, the BP was measured again for three times, which took about 10 minutes. The procedure is shown in Figure 2.

**2.4. Calculation of Mean BP and Statistics.** The whole measured area on the calf was divided into seven subareas (Figure 1). Area 1 was Chengshan (BL 57). Area 2 was

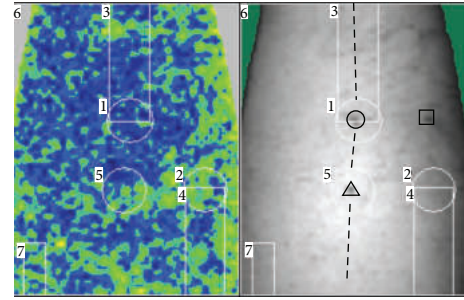

FIGURE 1: The position of acupunctured points and the area divisions for analyzing mean blood perfusion.  $\circ$  denotes Chengshan (BL57), and the broken line denotes bladder meridian.  $\triangle$  denotes the nonacupoint on bladder meridian, and  $\square$  denotes the nonacupoint off bladder meridian. The upper set of the figure is the direction of foot, and the inferior set is the direction of head.

a control point at comparative position of Chengshan (BL 57) when giving acupuncture at nonacupoint off meridian. Area 3 was the meridian area. Area 4 was a control area comparative to area 3. Area 5 was the area around the needling points. It was on bladder meridian (around  $\triangle$  in Figure 1) in nonacupoint on meridian group and lateral to bladder meridian in nonacupoint off meridian group (around  $\square$  which has not been shown in Figure 1). Area 6 was the whole measured area. Area 7 was a reference area that has no obvious relation with acupuncture and meridian.

After the seven subareas were divided, mean BP level in each area was calculated automatically by LDPIwin2.5 software which was obtained with the instrument. An important data analysis was achieved in our previous study that the BP at a reference area was gotten to represent the whole body change which was influenced by various unknown factors and by nonspecific effect of acupuncture [4, 8]. The specific local and meridian effects of acupuncture were overlapped on the whole body change. To enlarge the specific effects and minimize the fluctuation and nonspecific whole body effect of acupuncture, the ratio  $(BP_i/BP_{rf})$  between the BP on one area ( $BP_i$ ) except the reference area (area 7) and the BP on reference area ( $BP_{rf}$ ) was calculated as  $RBP_i$  ( $i$  is 1 to 6), and then the change rate of the ratio by time was calculated as  $(RBP_t - RBP_b)/RBP_b$ , ( $b$  denotes before acupuncture) again on each area (area 1 to area 6) which was called ratio change rate (RCR) in percentage ( $t$  is 2 to 9, representing nine measured times). Paired two-tailed  $t$ -test was used to compare the difference of RCR between nonacupoint on meridian group (on meridian group) and nonacupoint off meridian group (off meridian group).  $P < 0.05$  was set as the significant difference.

## 3. Results

After the ratio between the BP on one area and the BP on reference area ( $RBP_i$ ) was calculated and ratio change rate ( $RCR_t$ ) at different times was calculated, the mean RCRs of 20 subjects at six subareas are shown in Table 1.

TABLE 1: Ratio change rate of blood perfusion on difference areas during various periods of acupuncture (Mean  $\pm$  SD,  $n = 20$ ).

	Area 1	Area 2	Area 3	Area 4	Area 5	Area 6
On meridian						
Time 2	5.12 $\pm$ 11.48	7.0 $\pm$ 12.56	2.50 $\pm$ 8.69	2.56 $\pm$ 6.07	48.5 $\pm$ 37.09**	4.98 $\pm$ 7.24*
Time 3	6.26 $\pm$ 11.33	4.5 $\pm$ 14.02	4.01 $\pm$ 9.80*	2.89 $\pm$ 9.76	37.1 $\pm$ 25.84**	4.78 $\pm$ 7.74
Time 4	3.71 $\pm$ 9.69	2.6 $\pm$ 12.95	2.02 $\pm$ 6.08	0.55 $\pm$ 7.24	31.0 $\pm$ 22.44	2.58 $\pm$ 6.29
Time 5	2.55 $\pm$ 10.65	1.0 $\pm$ 11.86	0.26 $\pm$ 7.63	0.46 $\pm$ 7.26	24.4 $\pm$ 20.06*	1.10 $\pm$ 7.41
Time 6	1.74 $\pm$ 10.14	3.5 $\pm$ 12.46	2.7 $\pm$ 8.57	1.82 $\pm$ 7.06	24.3 $\pm$ 16.63	2.97 $\pm$ 6.84
Time 7	1.93 $\pm$ 11.22	2.1 $\pm$ 14.46	2.0 $\pm$ 7.62*	2.00 $\pm$ 8.32	32.0 $\pm$ 26.96	3.52 $\pm$ 7.77
Time 8	4.03 $\pm$ 13.67	4.1 $\pm$ 12.86	2.2 $\pm$ 10.41	2.68 $\pm$ 9.30	34.5 $\pm$ 30.77*	4.22 $\pm$ 8.75
Time 9	1.75 $\pm$ 9.38	3.1 $\pm$ 11.91	1.7 $\pm$ 7.67**	2.34 $\pm$ 6.63*	27.2 $\pm$ 25.12*	3.02 $\pm$ 6.16*
Off meridian						
Time 2	1.11 $\pm$ 9.89	3.89 $\pm$ 10.13	-1.90 $\pm$ 5.45	-1.0 $\pm$ 7.70	20.5 $\pm$ 15.10	-0.10 $\pm$ 6.08
Time 3	-0.32 $\pm$ 9.50	2.89 $\pm$ 11.40	-1.70 $\pm$ 5.09	-0.8 $\pm$ 8.00	20.2 $\pm$ 13.13	-0.11 $\pm$ 5.50
Time 4	1.96 $\pm$ 10.96	1.52 $\pm$ 7.66	-0.31 $\pm$ 7.90	0.47 $\pm$ 6.23	20.4 $\pm$ 12.56	0.77 $\pm$ 5.72
Time 5	-2.09 $\pm$ 9.65	1.74 $\pm$ 9.63	-2.88 $\pm$ 4.48	-1.2 $\pm$ 7.50	14.9 $\pm$ 8.21	-0.74 $\pm$ 5.27
Time 6	1.12 $\pm$ 9.69	5.68 $\pm$ 12.57	0.27 $\pm$ 5.69	0.91 $\pm$ 8.87	17.3 $\pm$ 11.45	2.29 $\pm$ 5.56
Time 7	-2.53 $\pm$ 12.25	2.96 $\pm$ 9.57	-3.31 $\pm$ 8.74	0.37 $\pm$ 7.80	18.7 $\pm$ 15.58	-0.75 $\pm$ 6.43
Time 8	-0.01 $\pm$ 10.27	2.54 $\pm$ 9.09	-2.20 $\pm$ 4.60	-0.1 $\pm$ 8.04	16.9 $\pm$ 14.14	0.09 $\pm$ 5.46
Time 9	-3.75 $\pm$ 9.78	-0.3 $\pm$ 9.68	-4.67 $\pm$ 7.50	-1.8 $\pm$ 7.04	11.6 $\pm$ 12.05	-1.70 $\pm$ 5.05

\* $P < 0.05$ , \*\* $P < 0.01$  as compared between on meridian group and off meridian group at same time period on the same area.

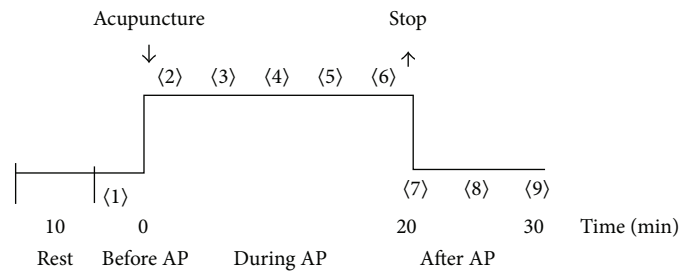

FIGURE 2: The procedure of the experiment. The number in  $\langle \rangle$  represents the scanning sequence for measurement of blood perfusion, and AP denotes acupuncture.

From the Table 1, the RCR at area 1, Chengshan (BL 57) and the control area (area 2) had no significant difference between needling the two points. However, the RCR on bladder meridian (area 3) in on meridian group was significantly higher than that in off meridian group during the needle retention period (time 3,  $P < 0.05$ ) and after withdrawal of the needle (time 7,  $P < 0.05$  and time 9,  $P < 0.01$ , see Figure 3), which implied a stronger effect along bladder meridian when acupuncturing at nonacupoint on the meridian. The average RCR during the whole observed periods was 2.2% in on meridian group and -2.1% in off meridian group, with total 4.3% difference between the two groups.

The difference in the RCR of BP on control area (area 4) that is similar to the size of meridian area (area 3) was not significant between on meridian group and off meridian group during most periods. However, at time 9 after withdrawal of the needle, the difference became significant, which indicates that acupuncture at nonacupoint on the meridian possesses a stronger lasting effect.

The local effect around needling points was compared between acupuncture at the two nonacupoints (Figure 4). RCR in acupuncture at nonacupoint on the meridian was significantly higher than that in acupuncture at nonacupoint off the meridian during needle retention period (time 2,  $P < 0.01$ ; time 3,  $P < 0.01$ ; time 5,  $P < 0.05$ ) and after withdrawal of the needle (time 8,  $P < 0.05$ ; time 9,  $P < 0.05$ ).

The holistic effect (area 6) still existed in on meridian group even when the pure holistic effect without local effect and meridian effect was diminished by calculation of the ratio, while it was nearly diminished (around zero) in off meridian group (Figure 5).

#### 4. Discussion

From the result of the previous experiment, a stronger effect of acupuncture on blood perfusion was found when needling the nonacupoint on meridian than needling the nonacupoint off meridian.

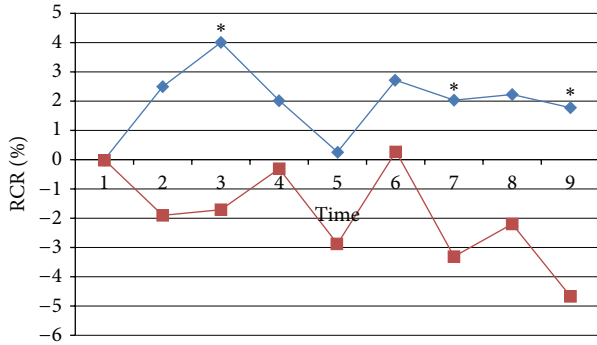

FIGURE 3: Ratio change rate (RCR) of BP on bladder meridian (area 3) when needling at nonacupoint on bladder meridian (blue line) and at nonacupoint off bladder meridian (red line). \* denoting a significant difference ( $P < 0.05$ ) between the two groups.

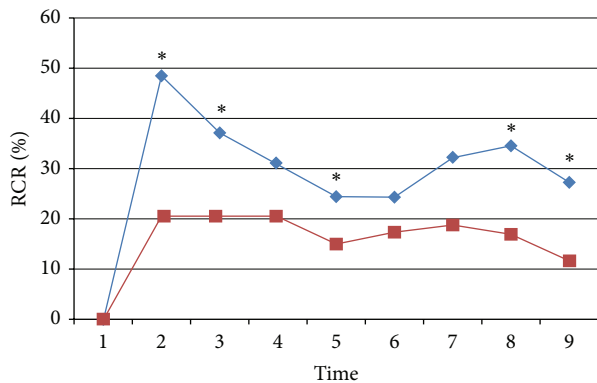

FIGURE 4: The local effect of ratio change rate (RCR) of BP around the needling points. Blue line denotes RCR in acupuncture at nonacupoint on the meridian, and red line denotes RCR in acupuncture at nonacupoint off the meridian. \* denoting a significant difference ( $P < 0.05$ ) between the two groups.

**4.1. The Methodology of Studying Meridian.** Many studies focused on comparing the difference of acupuncture effects between needling acupoint on meridians, and nonacupoint off meridians while little is known about the difference between needling nonacupoint on meridian and nonacupoint off meridian. Zheng et al. measured the blood perfusion at deep tissue using a needle-type detector and found little difference in increase of BP during acupuncture [9]. This result was similar to our observation that the difference in BP level on area 1 Chengshan (BL 57) which is a point-like small area was not significant between needling the two nonacupoints. The reason for this may be that the detected area on the meridian is too small to collect enough changes. When the detected area was enlarged on more meridian region like the field of rectangle in area 3, sufficient change could be obtained from the meridian to show the difference between meridian and bilateral control areas. So, an imaging technique is important in acupuncture and meridian study. Diminishing fluctuation from the whole body is also important as there is an overlapping from unavoidable environmental and mental noises on the real

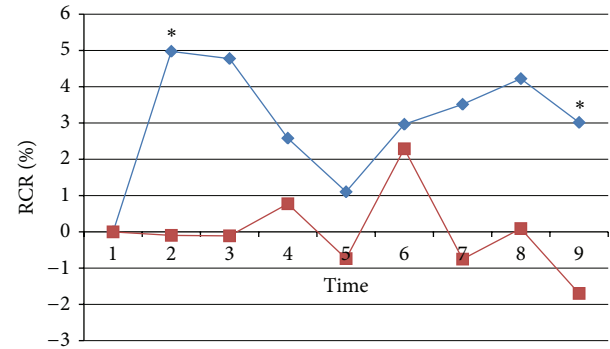

FIGURE 5: Ratio change rates of BP in on meridian group (blue line) and off meridian group (red line). \* denoting a significant difference between the two groups.

changes induced by acupuncture through meridians. The technique of getting fluctuation from a reference area and calculating the ratio with other areas proved to be effective in our previous studies [4, 8] and this study, which could be regarded as a technique of improving signal-to-noise ratio on meridians and acupoints.

**4.2. The Coherent Function of Meridians.** It remains a question that what is the role of meridian in acupuncture clinic. The ancient theory told us that you will make a mistake if you do not know the meridians. But modern acupuncture pays little attention to the importance of meridians. The precision of selecting an acupoint during acupuncture is an important factor to influence the acupuncture effect. In Song dynasty, a doctor must pass an examination of selecting acupoints on a bronze acupuncture figure in that water can flow out if he needles an acupoint correctly. The precision of selecting an acupoint depends on acupuncturist's experience at present during which the position of a selected point may miss the real acupoint but still on the meridian line or miss the real acupoint and miss the meridian at the same time. Acupoints along fourteen meridians are the main points used to apply acupuncture. Many acupoints along one meridian have similar function in treatment of the disease. The mechanism of the fact was speculated by ancient doctors that a "qi river (channel)" passes across these acupoints to transport the signals and effects. If the speculation is correct, it is reasonable to deduce that nonacupoints, but still locating on meridians can facilitate the transportation and therefore have a better effect.

Zhao et al. found an increase in gastric electric activity when acupuncture at Sibai (ST2) and Dichang (ST4) along the stomach meridian; however, no obvious changes were found when acupuncture at a nonmeridian point beside Sibai (ST2) and a point on small intestine meridian [10]. Huang et al. observed the blood flow on basilar artery when acupuncture at 5 acupoints, 4 nonacupoints along bladder meridian, and 9 nonmeridian points located on 2 cm lateral to the 9 points on the meridian. They found that the effect was the highest in the acupoints, secondary in nonacupoints, and the lowest in the nonmeridian points, which had shown an

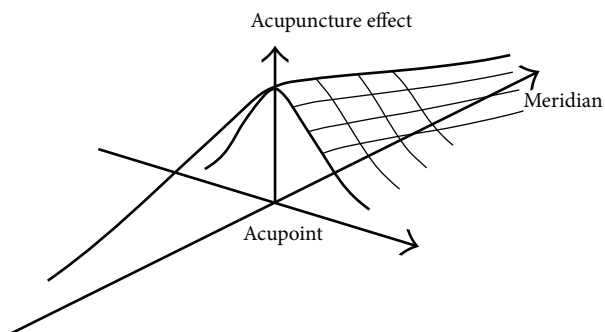

FIGURE 6: An illustration of acupuncture effect related with acupoints and meridians. There is a descending of effect from acupoint both along meridian and perpendicular to the meridian while the falling gradient is smooth along the meridian than perpendicular to the meridian.

important role of acupoints and meridians [11]. But they did not quantitatively compare the difference between needling nonacupoint and nonmeridian point with the same departure from an acupoint.

Our new result showed that when the points have the same departure from the acupoint, the local effect and meridian effect in nonacupoint are significantly higher than that in nonmeridian point. To see the local effect around the needling point immediately after acupuncture and combined with the data obtained before, 60.1%, 48.5%, and 20.5% increase in turn in acupoint, nonacupoint on meridians, and nonacupoint off meridians, which further proved the rule of acupuncture effect related to acupoints and meridians. The rule has been described roughly in Zhang's book "what is the meridian" in 1997 [12] and is redrawn in Figure 6 more vividly. The ancient theory of "rather missing acupoints than missing meridians" got a scientific elucidation.

**4.3. The Mechanism of Better Effects in Acupoints and Meridians.** The mechanism of the strongest acupuncture effect of needling acupoints might be due to the dense distributions of nerve terminals, blood vessels, and mast cells at the acupoint sites [13–15] at which stronger acupuncture signals like substance P (SP) and histamine can be produced by the needling through axon reflex [16]. The existed meridian channels can facilitate the process through transporting SP from nerve terminals to mast cells and transporting SP and histamine released from mast cells to the blood vessel to enhance the blood perfusion around the needling site and along the meridian as all the acupoints are located on the meridians.

The stronger effect of acupuncture at nonacupoints on meridians can be attributed to the existence of low hydraulic resistance channel along meridian which was found by Zhang et al. [17]. The channel allows more interstitial fluid flow and causes a transfer of histamine, SP, and other chemicals along meridians as a kind of volume transmission in peripheral tissue [18]. The transfer of chemicals and a series of axon reflexes along meridians can produce a propagated sensation along meridians [19] which is a famous phenomenon in

meridian study. The transmission of chemical and neural signals along meridians will also cause the acupuncture effect along meridians [4] and act on the organs where the meridian passes across. As long as the needle is inserted on a meridian, the signal is easy to be transported by the channel and easy to get an acupuncture effect, thus benefiting the treatment. So, it is important to keep the acupuncture on meridians. The ancient theory of "rather missing the acupoint than missing the meridian" has gotten an experimental verification and scientific understanding.

## 5. Conclusion

Nerve terminals, blood vessels, and mast cells can be regarded as the substance of acupoints through which stronger acupuncture signals can be produced to get the best effect. The low hydraulic resistance channel of interstitial fluid represents the entity of meridian channels which plays a role of signal transmitting channel to get a better effect of acupuncture.

## Conflict of Interests

All the authors declare that they have no conflict of interests.

## Acknowledgment

This work was supported by the grants (no. 30572307 and no. 308401) from National Natural Science Foundation of China.

## References

- [1] Z. J. (Ming Dynasty) Yang, "Compendium of acupuncture and moxibustion," vol. 2, pp. 68, <http://www.eshuba.com/soft/11745.htm>.
- [2] D. Zhang, S. Li, S. Wang, and H. Ma, "Preliminary study on mechanisms of acupuncture and moxibustion by laser Doppler perfusion imaging," *Chinese Acupuncture & Moxibustion*, vol. 24, no. 7, pp. 499–502, 2004.
- [3] G. Litscher, "Bioengineering assessment of acupuncture, part 2: monitoring of microcirculation," *Critical Reviews in Biomedical Engineering*, vol. 34, no. 4, pp. 273–293, 2006.
- [4] W.-B. Zhang, L.-L. Wang, T. Huang et al., "Laser Doppler perfusion imaging for assessment of skin blood perfusion after acupuncture," *Medical Acupuncture*, vol. 20, no. 2, pp. 109–118, 2008.
- [5] L.-L. Wang, W.-B. Zhang, H.-H. Xie, Y.-Y. Tian, and Y.-H. Xu, "Experimental verification of "treating lumbar-back problems by puncturing Weizhong (BL 40)" with blood perfusion imaging technique," *Acupuncture Research*, vol. 32, no. 4, pp. 247–251, 2007.
- [6] Y. Tian, T. Huang, G. Litscher et al., "Comparison of acupuncture hegu (LI4) by metal or laser needle on facial blood perfusion using laser speckle technique," *JAMS Journal of Acupuncture and Meridian Studies*, vol. 4, no. 3, pp. 187–192, 2011.
- [7] L. Wang, T. Huang, W. Zhang, and G. Litscher, "Violet laser acupuncture-part 2: effects on peripheral microcirculation," *JAMS Journal of Acupuncture and Meridian Studies*, vol. 4, no. 1, pp. 24–28, 2011.

- [8] Y. Y. Tian, W. B. Zhang, L. L. Wang et al., "Spontaneous fluctuation of skin blood perfusion on human hand back and data analysis," *Beijing Biomedical Engineering*, vol. 28, no. 1, pp. 61–64, 2009.
- [9] S. X. Zheng, J. S. Xu, X. H. Pan, and X. L. Hu, "Comparison of microcirculatory blood perfusion between acupoints of the stomach meridian and their bilateral control points and changes of blood flow after electroacupuncture in 21 volunteer subjects," *Acupuncture Research*, vol. 37, no. 1, pp. 53–58, 2012 (Chinese).
- [10] Y. L. Zhao, X. R. Chang, J. Yan, J. F. He, and J. S. Li, "The relationship between electroacupuncture at acupoints of stomach meridian and the variety of rat gastric myoelectric activity," *Chinese Archives of Traditional Chinese Medicine*, vol. 23, no. 10, pp. 1788–1790, 2005.
- [11] C.-Y. Huang, X.-L. Hu, C.-L. Ruan, J.-F. Su, and C.-J. Huang, "Clinical study on the holistic function of the bladder meridian of foot-taiyang," *Shanghai Journal of Acupuncture and Moxibustion*, vol. 24, no. 4, pp. 27–29, 2005.
- [12] W. B. Zhang, *What Are the Meridians*, China Science & Technology Publishing House, Beijing, China, 1997.
- [13] J. L. Wu, X. M. Chai, D. H. Cai, and D. Zong, "Observation on mast cells in subcutaneous connective tissue at points in albino rats," *Acta Anatomica Sinica*, vol. 11, no. 3, pp. 308–311, 1980.
- [14] H. C. Dung, "Anatomical features contributing to the formation of acupuncture points," *American Journal of Acupuncture*, vol. 12, no. 2, pp. 139–143, 1984.
- [15] D. Zhang, G.-H. Ding, X.-Y. Shen, W. Yao, and J. Lin, "Study on the correlation between meridian acupoints and mast cells," *Acupuncture Research*, vol. 3, no. 2, pp. 115–119, 2005.
- [16] B. Z. Zhang, "Discussion about the skin reaction along the meridians and the morphological and physiological basis of the PSC," *Journal of Xian Jiaotong University*, vol. 5, pp. 90–92, 1984.
- [17] W. B. Zhang, Y. Y. Tian, H. Li et al., "A discovery of low hydraulic resistance channel along meridians," *Journal of Acupuncture and Meridian Studies*, vol. 1, no. 1, pp. 20–28, 2008.
- [18] K. Fuxe, A. B. Dahlström, G. Jonsson et al., "The discovery of central monoamine neurons gave volume transmission to the wired brain," *Progress in Neurobiology*, vol. 90, no. 2, pp. 82–100, 2010.
- [19] W. B. Zhang, Y. Zhao, and K. Fuxe, "Understanding propagated sensation along meridians by volume transmission in peripheral tissue," *Chinese Journal of Integrative Medicine*, vol. 19, no. 5, pp. 330–339, 2013.

## Research Article

# Network Analysis of Acupuncture Points Used in the Treatment of Low Back Pain

Soon-Ho Lee,<sup>1,2</sup> Chang-Eop Kim,<sup>3</sup> In-Seon Lee,<sup>1</sup> Won-Mo Jung,<sup>4</sup> Hong-Gee Kim,<sup>2</sup> Hyunchul Jang,<sup>5</sup> Sang-Jeong Kim,<sup>3</sup> Hyejung Lee,<sup>1</sup> Hi-Joon Park,<sup>1</sup> and Younbyoung Chae<sup>1,4</sup>

<sup>1</sup> Acupuncture and Meridian Science Research Center, College of Korean Medicine, Kyung Hee University, 1 Hoegi-dong, Dongdaemungu, Seoul 130-701, Republic of Korea

<sup>2</sup> Biomedical Knowledge Engineering Laboratory, BK21 College of Dentistry, Seoul National University, Seoul 110-744, Republic of Korea

<sup>3</sup> Department of Physiology, College of Medicine, Seoul National University, Seoul 110-744, Republic of Korea

<sup>4</sup> Department of Brain Cognitive Engineering, Korea University, Seoul 136-713, Republic of Korea

<sup>5</sup> Informatics Development & Management Group, Korea Institute of Oriental Medicine, Daejeon 305-390, Republic of Korea

Correspondence should be addressed to Younbyoung Chae; [ybchae@khu.ac.kr](mailto:ybchae@khu.ac.kr)

Received 11 April 2013; Accepted 4 June 2013

Academic Editor: Wei-bo Zhang

Copyright © 2013 Soon-Ho Lee et al. This is an open access article distributed under the Creative Commons Attribution License, which permits unrestricted use, distribution, and reproduction in any medium, provided the original work is properly cited.

**Background.** The appropriate selection of acupoints is fundamental to obtain a therapeutic effect from clinical acupuncture. **Objective.** Using a network analysis method, we investigated the acupoints that are combined to treat low back pain (LBP). **Methods.** To analyze the patterns of the combinations of acupoints, we used acupoint information from clinical trials to calculate the modified mutual information (MI) value, integrated these data, and visualized the network. **Results.** Based on the highest MI values, we found two different types of acupoint pairs used in the treatment of LBP: pairs of distant acupoints and pairs of local acupoints. Using modular analysis, we found that three acupoint modules were applied in the treatment of LBP: local acupoints, distant acupoints along the meridian, and distant acupoints based on the symptom differentiations. **Conclusion.** Using the modified MI technique, we provide a systematic framework for the acupoint combination network, and reveal how the technique of acupoint combination is used in the treatment of LBP. Application of this knowledge in acupuncture research may help clarify the mechanisms underlying acupuncture treatment at the systems level, bridging the gap between traditional medicine and modern science.

## 1. Introduction

According to traditional Asian medicine, the human body has more than 360 acupoints. Numerous combinations of these acupoints are used clinically. Ancient acupuncture practitioners discovered the therapeutic properties of acupoints and their effects not only on a particular internal organ, but also at distant parts of the body. The meridian system is a systematic order of empirical knowledge that functions as the basis of acupuncture treatment [1]. It has been reported that acupoints could exert synergistic and antagonistic actions [2, 3]. The selection of appropriate acupoint combinations is the first step in ensuring the therapeutic effect of acupuncture [4]. Practitioners select acupoints based on three basic principles:

(1) local acupoints near the area where symptoms occur, (2) distant acupoints along the meridian, and (3) distant acupoints based on symptom differentiation [2].

Network science is a systems science method that is now used to construct holistic systems in diverse fields, such as the natural sciences, social sciences, and humanities [5]. Emerging trends in this new analytical science, which is based largely on graph theory, have been rapidly transferred to studies of network organization [6]. Graph theory is a natural system that can ensure the exact mathematical representation of complex networks, by representing a complex network as a graph. Network analyses use graph theory: a network is defined as a set of nodes (or vertices) and edges (or lines) between them [6, 7]. How is it possible to systematically

observe the principles of acupuncture using network science? We should start by considering the similarity between the meridian system and a network.

The meridian system is a holistic medical system that focuses on functioning at the whole-body level, and has its own theoretical framework [1, 8]. Abundant clinical data are available regarding acupuncture treatment, which is based on the holistic philosophy of traditional Asian medicine [9, 10]. The meridian system is one part of this philosophy; it consists of lines that connect surface points, which are called acupoints. Although the positions of acupoints vary according to different theories, approximately 360 acupoints are associated with 12 principal meridians. These acupoints can be considered nodes, and the meridians can be considered the edges connecting the nodes. The principles of systems biology, which is mainly associated with regulating the body's internal environment to maintain stable conditions, are closely related to those of traditional Asian medicine [11, 12]. A recent study used complex network analysis to examine the selection of acupoints for different symptoms; it matched the symptoms that every acupoint was used to treat and produced different distribution patterns [13]. Recently, Wu et al. [14] used complex network analysis to clarify the regularities and mechanisms of a reasonable combination of acupoints. Although such a bottom-up approach might seem at odds with the holistic concept of the meridian system, new research methods that incorporate the holistic features of the meridian system are urgently needed for its modernization.

In this study, we applied network analysis to determine how acupoints have been used together in combination for the treatment of low back pain (LBP). To analyze patterns in these combinations of acupoints, we calculated the modified mutual information (MI) value, integrated the data, and visualized the network based on acupoint-related information extracted from clinical trials for LBP.

## 2. Methods

**2.1. Sources of Data about Acupoints for Low Back Pain.** Previously, we analyzed the patterns of acupoints that were combined to treat LBP in 53 studies (28 Korean, 25 international; see [15]). The 33 most commonly used acupoints (frequency > 5%) were included in the present analysis of the patterns used in the acupuncture treatment for LBP.

**2.2. Acupoint Combination Network Construction.** To determine the extent of acupoint combinations used for treating LBP among each pair of the 33 acupoints, we calculated the modified MI values as described by [16], where the MI value between acupoints  $x$  and  $y$  was defined as  $MI(x, y) = P(x, y) * \ln(P(x, y) / (P(x) * P(y)))$ , where  $P(x, y) = \sum_{i=1}^m I(x, y, i) / m$  is the coincidence frequency of  $x$  and  $y$  and  $P(x) = \sum_{i=1}^m I(x, i) / m$  is the frequency of acupoint  $x$ . This formula is the same for  $P(y) \cdot I(x, y, i)$  is the indicator function of  $x$  and  $y$ , showing whether acupoints  $x$  and  $y$  were used together in study  $i$  and  $m$  is the total number of studies investigated. An MI matrix ( $33 \times 33$ ) was constructed to represent the acupoint combination network, where  $a_{ij}$  indicates the MI value between acupoints  $i$  and  $j$ .

**2.3. Binarization of MI Matrix.** To make the network tractable for analyses, the MI matrix was converted into binary adjacency matrices with only 1 or 0 as elements. While the binarizing process is commonly used for network analyses, this must be done with care to avoid misrepresenting the network by applying a specific threshold [17, 18]. We constructed adjacency matrices by applying various thresholds  $R$  ( $0.001 \leq R \leq 0.999$ , in 0.001 increments). This prevented increased numbers of spurious edges and decreased the edge densities of the network, ultimately fragmenting the network into components that are inappropriate for graphtheory analyses. The maximum  $R$  retaining a fully connected network was 0.022. At this threshold, the edge density was 0.39. We performed all subsequent network analyses for multiple binary networks with edge densities ranging from 0.39–0.50, which retained possibly strong edges only, while the network remained fully connected. The resulting binary networks were very similar; the data are shown only for the network with an edge density of 0.40.

**2.4. Network Analysis.** Network analysis was performed using Brain Connectivity Toolbox (BCT, <http://www.brain-connectivity-toolbox.net>) [19]. To investigate the modular structure of the acupoint combination network, an optimization algorithm that maximizes the number of within-group edges and minimizes the number of between-group edges [20] was applied to the binarized matrix. The maximum modularity ( $Q$ ), which quantifies the strength of the modular structure, is defined as  $Q = (1/4l) \sum_{ij} (a_{ij} - k_i k_j / 2l) \delta_{ij}$ , where  $l$  is the total number of the edges in the network;  $a_{ij} = 1$  if node  $i$  and  $j$  are connected and 0 otherwise;  $k_i$  and  $k_j$  are the degree of each node; and  $\delta_{ij} = 1$  if  $i$  and  $j$  belong to the same module and 0 otherwise. We measured the degree and betweenness centralities of every node in each network. The degree centrality and betweenness centrality of node  $i$  are defined as the number of edges belonging to  $i$  and the fraction of shortest paths between any pair of nodes in the network passing through node  $i$ , respectively. The degree centrality is represented as the number of nodes to which a focal node is connected, and measures the involvement of the node in the network [21]. The betweenness centrality is a measure of the centrality of a node in a network and is equal to the number of shortest paths from all vertices to all others that pass through that node [22, 23].

**2.5. Network Visualization.** Networks were visualized using Cytoscape 2.8.3 (<http://www.cytoscape.org/>). We used two forms to visualize the networks: a circular layout based on modularity analysis and a force-directed layout to show the degree and betweenness centrality analysis. A circular layout places all nodes on a single circle and connects them with edges, while a force-directed layout basically uses dynamic theory [24].

## 3. Results

**3.1. Acupoint Combination Network for Low Back Pain.** This study used a modified MI technique to extract the relationships among the 33 acupoints. We examined all possible pairs

TABLE 1: Acupoint pairs with high mutual information values.

Acupoint pairs	MI value
(L) BL24-BL25	0.2678
(L) BL31-BL33	0.2227
(L) BL31-BL34	0.2227
(L) BL33-BL34	0.2227
(L) BL32-GB30	0.2069
(L) BL24-BL26	0.2069
(L) BL25-BL26	0.2023
(L) BL23-BL25	0.2018
(D) BL40-GB34	0.1966
(L) BL23-BL32	0.1909
(D) GB34-ST36	0.1900
(D) BL40-BL60	0.1786
(L) GB30-BL24	0.1786

Acupoint pairs with mutual information values  $> 0.17$  are shown. (L) indicates local acupoint pairs and (D) indicates distant acupoint pairs.

and identified the most frequently used acupoint pairs. From the 13 highest MI values ( $>0.17$ ), we found two different types of pair used to treat LBP (Table 1): pairs of local acupoints (BL24-BL25, BL31-BL33, BL31-BL34, BL33-BL34, BL32-GB30, BL24-BL26, BL23-BL25, BL23-BL32, and GB30-BL24) and pairs of distant acupoints (BL40-GB34, GB34-ST36, and BL40-BL60).

The acupoints ranked 18 to 20, that is, BL31, BL32, and BL33, had the highest MI values (Figure 1(a); yellow in the middle). The acupoints ranked 29 to 33, that is, LU8, SP3, HT8, SP2, and KI10, had relatively high MI values (Figure 1(a); light green in the right bottom). These acupoints originally ranked lower, but they were frequently used in combination, thereby increasing their MI values.

**3.2. Modularity Analysis.** To identify patterns in the combinations of acupoints used to treat LBP, we performed a modularity analysis and illustrated the modular structure using a circular layout (Figure 2). We applied an optimization algorithm that maximizes the number of within-group edges and minimizes the number of between-group edges and thereby categorized the 33 acupoints into three acupoint modules. Module A included BL23, BL25, BL24, BL26, BL57, BL32, GV3, GV4, BL52, BL22, BL27, BL31, BL33, and BL34 (Figure 2, blue nodes). Module B included BL60, GB30, BL40, GB34, BL37, ST36, BL62, SI3, and SI6 (Figure 2, orange nodes). Module C included LI4, KI3, LU8, SP9, LR3, KI7, SP3, SP2, HT8, and KI10 (Figure 2, green nodes). Based on the characteristics of the acupoints used to treat LBP, we called Module A the Local Acupoints group, Module B the Distant Acupoints group (Type I: Distant acupoints along the meridian), and Module C the Distant Acupoints group (Type II: Distant acupoints based on symptom differentiation).

**3.3. Network Analysis.** Degree centrality analysis is useful when detecting acupoints generally used together. Nodes BL23, BL24, BL25, BL26, BL60, and GB30 had many edges, which can be explained by their frequent use in treating LBP

TABLE 2: Frequency, degree centrality, and betweenness centrality of acupoints.

Rank	Acupoint	Frequency (%)	Degree	Betweenness centrality
1	BL23	50.9	19	0.01747
2	BL25	43.4	19	0.02772
3	BL40	32.1	11	0.00809
4	BL60	32.1	20	0.04194
5	GB30	32.1	20	0.02363
6	BL24	32.1	19	0.05881
7	BL32	28.3	18	0.01249
8	BL26	28.3	20	0.07760
9	GB34	20.8	11	0.01639
10	ST36	15.1	13	0.03434
11	BL57	11.3	15	0.00338
12	BL62	11.3	5	0.00108
13	BL52	11.3	16	0.01067
14	GV3	11.3	14	0.00245
15	KI3	11.3	12	0.11167
16	GV4	9.4	18	0.02451
17	LI4	9.4	10	0.04310
18	BL31	9.4	15	0.01335
19	BL33	9.4	15	0.01335
20	BL34	9.4	15	0.01335
21	BL22	7.5	9	0.00827
22	SI6	7.5	9	0.00131
23	LR3	7.5	4	0.01094
24	SI3	7.5	13	0.04064
25	BL27	7.5	4	0.00000
26	KI7	7.5	8	0.01540
27	BL37	5.7	16	0.03787
28	SP9	5.7	14	0.13137
29	LU8	5.7	8	0.00065
30	SP3	5.7	8	0.00065
31	HT8	5.7	8	0.00065
32	SP2	5.7	8	0.00065
33	KI10	5.7	8	0.00065

(Figure 3(a)). Figure 3(b), which describes the betweenness centrality of each acupoint, had a different color distribution compared to Figure 3(a). Although some acupoints have few edges, they still appear as red nodes, indicating that they have higher betweenness centrality values. Acupoints KI3 and SP9 had the highest betweenness centrality values, suggesting that these points play an important role in connecting the vertices to all others that pass through that node. We also analyzed the frequency, degree centrality, and betweenness centrality of each acupoint used in the treatment of LBP (Table 2).



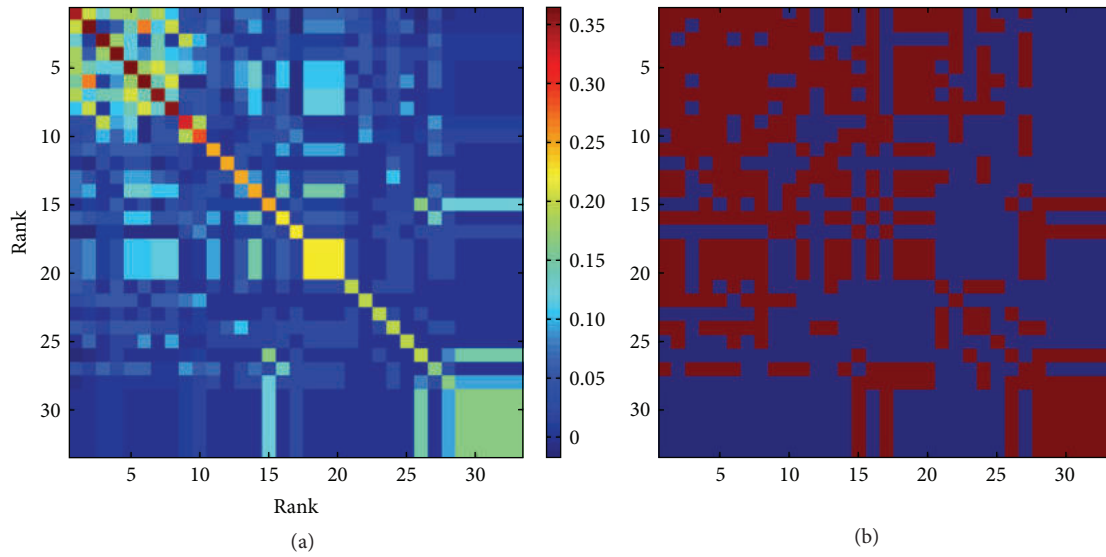

FIGURE 1: (a) The MI matrix for acupoint combinations used to treat LBP. The coordinates indicate the order of the main acupoints used for treating LBP. The distance-based mutual information model explains the relationships between all pairs of the 33 acupoints. (b) Binarized MI matrix for the acupoint pairs (threshold value = 0.031). Pairs exceeding the threshold were scored 1 and are shown in red. Pairs below the threshold were scored 0 and these pixels are in blue.

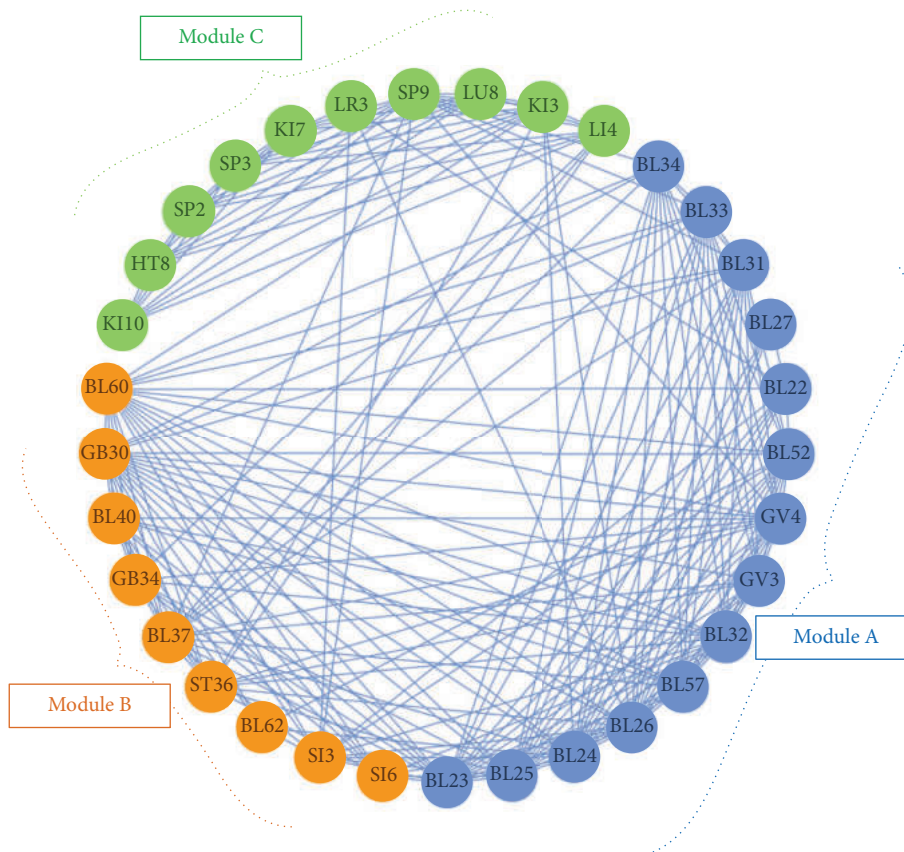

FIGURE 2: The network model based on module analysis, showing the grouped acupoints. Three modules were identified and are shown in this circular form: Module A (blue nodes), acupoints BL23, BL25, BL24, BL26, BL57, BL32, GV3, GV4, BL52, BL22, BL27, BL31, BL33, and BL34; Module B (orange nodes), acupoints BL60, GB30, BL40, GB34, BL37, ST36, BL62, SI3, and SI6; and Module C (green nodes), acupoints LI4, KI3, LU8, SP9, LR3, KI7, SP3, SP2, HT8, and KI10.

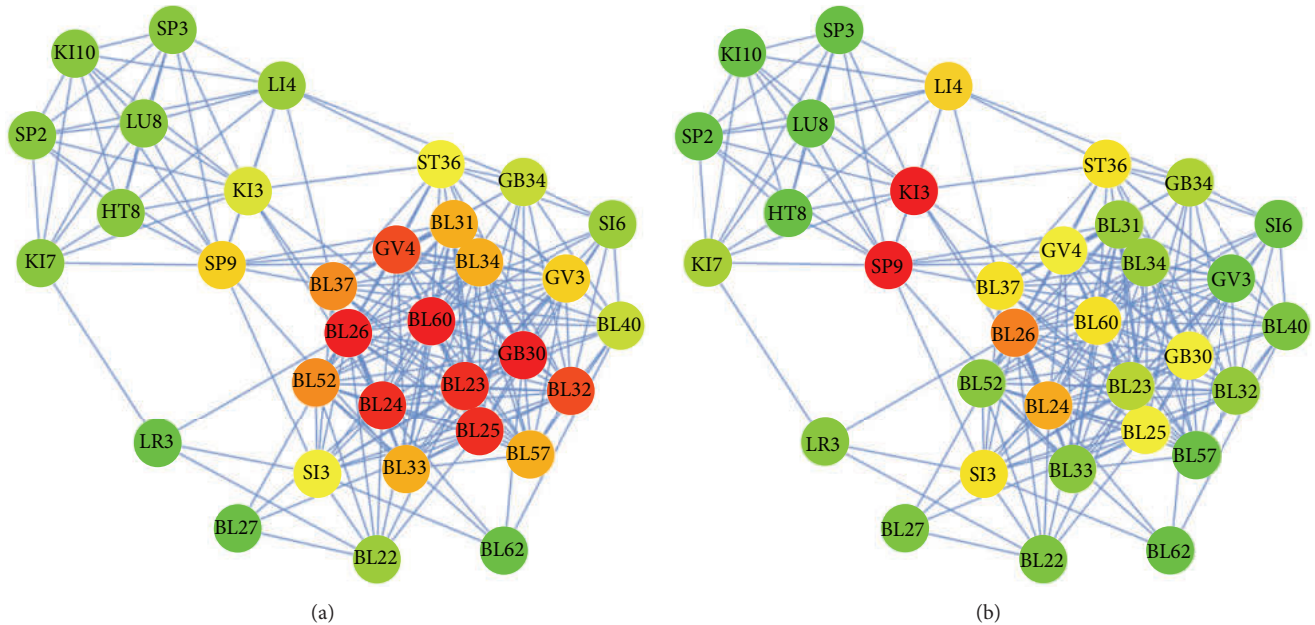

FIGURE 3: Network models showing degree centrality (a) and betweenness centrality (b). Unlike Figure 2, which groups similar acupoints as modules, this figure separates each acupoint and connects each pair with edges. In both figures, red nodes indicate a high degree of betweenness centrality, green nodes indicate a low value, and yellow nodes indicate an intermediate value.

#### 4. Discussion

Many patients visit traditional Asian medical clinics for acupuncture treatment. In this study, we examined what principles practitioners use to select acupoints to treat a given disease. We analyzed patterns in the combinations of acupoints used to treat LBP in clinical trials. First, we visualized the distribution of acupoint pairs based on MI values, and then we analyzed these using three different network analysis methods. These methods allowed us to identify which acupoints are frequently used together to treat LBP, and which acupoint combinations are grouped.

An MI value expresses the frequency at which a pair is used together and is defined as the intersection proportion of each proportion. Figure 1(a) is a matrix that shows MI values; the areas with high MI values are easily seen. In some ways, but not all, this result is similar to frequency: high-frequency points have large MI values. We identified which acupoints were chosen together to treat LBP, based on MI values. Ranks 18 to 20, that is, acupoints BL31, BL32, and BL33, had relatively higher MI values (Figure 1(a), yellow in the middle). These acupoints, known as the Eight Foramen Acupoints (located in the sacral foramen), are commonly used to treat LBP [25]. Additionally, acupoints LU8, SP3, HT8, SP2, and KI10 are usually used together, as shown in the MI matrix. These acupoints are the major components of the Saam Acupuncture and Eight Constitution Acupuncture regimens based on Five Phase theory and are commonly used together to treat LBP [10]. For a more elaborate explanation, we extracted the MI values listed in Table 1. The table lists the two different types of pairs of acupoints used in the treatment of LBP. One group consists of pairs between distant

acupoints (e.g., BL40-GB34, GB34-ST36, and BL40-BL60), while the others are local acupoints close to the symptomatic area. The combinations involving distant acupoints might be derived from the basic principle of selecting acupoints along a meridian.

In Figure 2, the nodes are arranged around the circumference of a circle. Module A includes acupoints BL23, BL25, BL24, BL26, BL57, BL32, GV3, GV4, BL52, BL22, BL27, BL31, BL33, and BL34. All of these acupoints are on the *Bladder meridian* and the *Governing vessel*, especially at the low back position of these meridians. In traditional Asian medicine, these are considered “local acupoints,” and a local acupoint is the original and most basic choice for treatment. Module B includes acupoints BL60, GB30, BL40, GB34, BL37, ST36, BL62, SI3, and SI6. Most of these are on the *Bladder* and *Gallbladder meridians*. However, these differ from those in Module A in that the nodes are on the limbs. These are so-called “distant acupoints” and are located in positions that cause pain through the same meridian on the opposite side of the body or the adjacent meridian. These points function as a “remote control panel” of the meridian Qi. Finally, Module C includes acupoints LI4, KI3, LU8, SP9, LR3, KI7, SP3, SP2, HT8, and KI10. These acupoints are generally positioned on the limbs but not on the *Bladder meridian*. They are used to treat LBP based on symptom differentiation. These findings about the three acupoint modules confirmed that the three basic principles of acupuncture regimens (local acupoints, distant acupoints along the meridian, and distant acupoints based on symptom differentiation) are also applied in the treatment of LBP [2].

In the network analysis, we analyzed the degree and betweenness centrality. The results are shown in Figure 3.

In Figure 3(a), nodes with a high degree value are colored red, while ones with low values are green. Acupoints BL23, BL25, BL60, GB30, and BL26 appear to be widely used to treat LBP. While the degree refers to the strength of one node in connections, betweenness centrality implies the rate of connectivity between a node and other indirect nodes. As shown in Figure 3(b), acupoints KI3 and SP9 are nodes that connect Module C (distant acupoints based on symptom differentiation) to Module A (local acupoints) or Module B (distant acupoints along the meridian). These points function as “hubs” that connect to different types of node. Therefore, we postulate that acupoints KI3 and SP9 play a crucial role in the interconnection between the local and distant acupoints modules.

In summary, this study clarified which acupoints are frequently used together to treat LBP. The modified MI technique provides a systematic framework for the acupoint combination network and helps reveal how the technique of acupoint combination is used in the treatment of LBP. This study is the first to apply network science to explore unique theories related to the meridian system, and the findings provide new insights into acupoint selection based on biomedical information. Combining network science with clinical data about acupuncture treatment will help facilitate the evaluation of the therapeutic effects of acupuncture, and its possible mechanisms at the system level, bridging the gap between traditional medicine and modern science.

### Conflict of Interests

The authors report no conflicts of interest.

### Authors' Contribution

Soon-Ho Lee and Chang-Eop Kim equally contribute to this paper.

### Acknowledgments

This research was supported by a Grant-in-Aid from the Korea Institute of Oriental Medicine (no. K13090) and the Basic Science Research Program through the National Research Foundation of Korea (NRF), funded by the Ministry of Education, Science and Technology (no. 2005-0049404).

### References

- [1] C.-S. Yin and H.-G. Koh, “What’s the original concept of meridian and acupuncture point in oriental medicine?—a perspective of medical history,” *Uisahak*, vol. 14, no. 2, pp. 137–150, 2005.
- [2] Y.-R. Chen, J. Zhu, J.-S. Song, and Y.-F. She, “Discussion on point selection and compatibility of acupuncture formula,” *Zhongguo Zhen Jiu*, vol. 32, no. 1, pp. 65–68, 2012.
- [3] F. Zhong, F. Zeng, H. Zheng, C. Ren, R.-J. Jin, and Y. Li, “Present study on antagonistic effect of acupoints compatibility,” *Zhongguo Zhen Jiu*, vol. 31, no. 12, pp. 1093–1096, 2011.
- [4] H. Wang and F. X. Liang, “Thoughts and prospects of research on acupoints compatibility,” *Zhongguo Zhen Jiu*, vol. 32, no. 4, pp. 359–362, 2012.
- [5] K. Börner, S. Sanyal, and A. Vespignani, “Network science,” *Annual Review of Information Science and Technology*, vol. 41, pp. 537–607, 2007.
- [6] E. Bullmore and O. Sporns, “Complex brain networks: graph theoretical analysis of structural and functional systems,” *Nature Reviews Neuroscience*, vol. 10, no. 3, pp. 186–198, 2009.
- [7] S. Boccaletti, V. Latora, Y. Moreno, M. Chavez, and D.-U. Hwang, “Complex networks: structure and dynamics,” *Physics Reports*, vol. 424, no. 4–5, pp. 175–308, 2006.
- [8] W. Jung, “The origin of Jingmai: through the investigation into some important hypotheses,” *Korean Journal of Medical History*, vol. 19, no. 2, pp. 433–457, 2010.
- [9] A. J. Vickers, A. M. Cronin, A. C. Maschino et al., “Acupuncture for chronic pain: individual patient data meta-analysis,” *Archives of Internal Medicine*, vol. 172, no. 19, pp. 1444–1453, 2012.
- [10] C. Yin, H.-J. Park, Y. Chae et al., “Korean acupuncture: the individualized and practical acupuncture,” *Neurological Research*, vol. 29, no. 1, pp. S10–S15, 2007.
- [11] J. Van Der Greef, “Perspective: all systems go,” *Nature*, vol. 480, no. 7378, p. S87, 2011.
- [12] H. Kitano, “Systems biology: a brief overview,” *Science*, vol. 295, no. 5560, pp. 1662–1664, 2002.
- [13] Y.-Y. Wang, F. Lin, and Z.-L. Jiang, “Pattern of acupoint selection based on complex network analysis technique,” *Zhongguo Zhen Jiu*, vol. 31, no. 1, pp. 85–88, 2011.
- [14] Q. F. Wu, C. S. Zhang, Q. Chen, and S. G. Yu, “On feasibility of researching acupoint combination by using complex network analysis techniques,” *Zhen Ci Yan Jiu*, vol. 37, no. 3, pp. 252–255, 2012.
- [15] I. Lee, H. Jo, S. Lee et al., “Systematic review of selection of acupuncture points for lower back pain,” *Korean Journal of Acupuncture*, vol. 29, no. 4, pp. 519–536, 2012.
- [16] S. Li, B. Zhang, D. Jiang, Y. Wei, and N. Zhang, “Herb network construction and co-module analysis for uncovering the combination rule of traditional Chinese herbal formulae,” *BMC Bioinformatics*, vol. 11, no. 11, article S6, 2010.
- [17] G. S. Wig, B. L. Schlaggar, and S. E. Petersen, “Concepts and principles in the analysis of brain networks,” *Annals of the New York Academy of Sciences*, vol. 1224, no. 1, pp. 126–146, 2011.
- [18] J. D. Power, D. A. Fair, B. L. Schlaggar, and S. E. Petersen, “The development of human functional brain networks,” *Neuron*, vol. 67, no. 5, pp. 735–748, 2010.
- [19] M. Rubinov and O. Sporns, “Complex network measures of brain connectivity: uses and interpretations,” *NeuroImage*, vol. 52, no. 3, pp. 1059–1069, 2010.
- [20] M. E. Newman, “Finding community structure in networks using the eigenvectors of matrices,” *Physical Review E*, vol. 74, no. 3, Article ID 036104, 2006.
- [21] T. Opsahl, F. Agneessens, and J. Skvoretz, “Node centrality in weighted networks: generalizing degree and shortest paths,” *Social Networks*, vol. 32, no. 3, pp. 245–251, 2010.
- [22] M. Barthélemy, “Betweenness centrality in large complex networks,” *European Physical Journal B*, vol. 38, no. 2, pp. 163–168, 2004.
- [23] K.-I. Goh, E. Oh, B. Kahng, and D. Kim, “Betweenness centrality correlation in social networks,” *Physical Review E*, vol. 67, no. 1, Article ID 017101, 2003.

- [24] K. Han and B.-H. Ju, "A fast layout algorithm for protein interaction networks," *Bioinformatics*, vol. 19, no. 15, pp. 1882–1888, 2003.
- [25] I. Lund, T. Lundeberg, L. Lönnberg, and E. Svensson, "Decrease of pregnant women's pelvic pain after acupuncture: a randomized controlled single-blind study," *Acta Obstetrica et Gynecologica Scandinavica*, vol. 85, no. 1, pp. 12–19, 2006.

## Research Article

# Pathological Changes in Internal Organs after Blocking Low Hydraulic Resistance Channels along the Stomach Meridian in Pigs

Wen-Ting Zhou,<sup>1</sup> Shu-Yong Jia,<sup>1</sup> Yu-Qing Zhang,<sup>1,2</sup> Yu-Ying Tian,<sup>1</sup> Guang-Jun Wang,<sup>1</sup> Tao Huang,<sup>1</sup> Li Pang,<sup>1</sup> Yong-Sheng Zhou,<sup>3</sup> Xue-Yan Sun,<sup>3</sup> and Wei-Bo Zhang<sup>1</sup>

<sup>1</sup> Institute of Acupuncture & Moxibustion, China Academy of Chinese Medical Sciences, 16 Nanxiaoje, Dongzhimennei, Beijing 100700, China

<sup>2</sup> World Federation of Chinese Medicine Societies, Beijing 100029, China

<sup>3</sup> Institute of Chinese Materia Medica, China Academy of Chinese Medical Sciences, Beijing 100700, China

Correspondence should be addressed to Wei-Bo Zhang; zhangweibo@hotmail.com

Received 14 April 2013; Accepted 23 May 2013

Academic Editor: Younbyoung Chae

Copyright © 2013 Wen-Ting Zhou et al. This is an open access article distributed under the Creative Commons Attribution License, which permits unrestricted use, distribution, and reproduction in any medium, provided the original work is properly cited.

**Objective.** The correlation between meridians and organs (Zang-fu) is an important aspect of meridian theory. The objective of this paper is to investigate the pathological changes in the organs resulting from blocking low hydraulic resistance channel (LHRC) along the stomach meridian by injecting gel in pigs so as to offer some insight into the correlation between meridians and internal organs. **Methods.** Four white piglets and twelve black minipigs were divided into four batches and were observed in different periods. Each batch included two pairs of pigs and each pair matched two pigs with similar conditions among which gel was injected into 6~8 low hydraulic resistance points along the the stomach meridian in the experimental pig and the same amount of saline was injected into the same points in the control pig. The state of stomach and intestine was observed 6~10 weeks after the blocking model was developed. **Results.** The results showed that there were bloated stomach or/and intestine in all the experimental pigs while there were normal states in seven control pigs except one dead during the experiment. **Conclusion.** The findings confirmed that the blockage of LHRC along the stomach meridian can influence the state of stomach and intestine, leading to a distension on stomach or/and intestine.

## 1. Introduction

Meridians and collaterals are critical system in keeping health by transporting Qi-Blood, nourishing tissue, communicating between somata and viscera, and balancing Yin-Yang according to the classic theory of traditional Chinese medicine (TCM) [1]. If a meridian gets a problem, a stasis, for instance, the running of Qi-Blood will be slow or even stopped and the organ related to the meridian may become disordered and gradually develop a disease. This important pathological view in TCM is quite different from the one in Western medicine. It is unbelievable to the actions of the meridian from the view of Western medicine as no meridian structure has been observed using anatomic technique. However, countless clinical effects of acupuncture indicate that there is an unknown

regulating system in our body which is related to the meridians and the acupoints on the meridians.

The correlation between meridians and internal organs is an important aspect of meridian theory. Acupuncturists treat a visceral disease through needling the acupoints located on the related meridian. A systematic analysis was made recently on the correlation between acupoints and pathological changes of the internal organs through reviewing of literatures in the database of CNKI (China's National Knowledge Infrastructure) from 1959 to 2011 and the database of Pubmed (US National Library of Medicine) in the past 10 years. The result showed that specificity was found on the pathological changes of Zang-fu (viscera) organs when acupoints were stimulated [2]. The influence of meridians to the organs was confirmed through acupoint stimulation while it remained

a secret if there is a pathological change in an organ when the related meridian gets a problem. To answer the question, we must firstly answer what are the meridians and the Qi in meridian channels. In Yellow Emperor's canon of internal medicine, Qi was defined to fill into the physique and moisten the fine hair like the dew moistening the grasses and woods [3]. Qi can also transform into five kinds of fluid: when the weather is cold and one's clothes are thin, most of them will be changed into urine and vapour; when the weather is hot in summer and one's clothes are thick, most of them will be wet; when one's mood is in sorrow and the energy merges into the heart, they will transform into tears; when there is heat in the middle warmer and the stomach energy is flaccid and slow, they will change into saliva. When the evil energy is blocking inside, the Yang energy is obstructed and fails to circulate; edema will occur [4]. The unique thing owning these properties is the interstitial fluid (IF) which occupies about 20% of our body volume. IF exists among many tiny holes constructed by collagen and fine fibers of glycosaminoglycan in extracellular space. The early idea of IF comes from Guyton et al. in 1966 who claimed that IF is gel-like substance which is almost immobile [5]. But this point of view was challenged by many scientists in Europe like Aukland and Reed [6] and Levick [7] who published large review articles to prove the existence of two phase of IF, one is gel, the other is free fluid which can flow in tissue. In 2007, Swartz and Fleury discussed the functions of IF flow on cell-cell signaling and morphogenesis [8].

The flow of IF in porous medium follows Darcy's law (1856) that the flux is positively proportional to pressure gradient and negatively proportional to the hydraulic resistance (HR) of tissue [7]. And the fluid must follow the conservation equation which means it must flow continuously without compression [7]. In 1997, Zhang put forward a hypothesis that meridians are the tissue which has lower HR and IF will flow toward the meridians and along the meridians according to the laws [9].

This hypothesis was basically proven by finding a series of low HR points along meridians, a good transportation of IF pressure wave along meridians, and a migration of isotope along meridians in Zhang's lab in 90s in the twentieth century. A low hydraulic resistance channel (LHRC) along meridians was finally discovered which may represent partly the essence of meridians [10].

The further study is to identify the function of LHRC. One of the functions is in pathological aspect. According to Yellow Emperor's canon, meridian channels have a pathological state of blockage which is the main cause of many diseases. To establish a blocking model of meridian channels, Xu et al. developed a method by injecting hydrogel into low HR points along meridians and measured the transportation of IF pressure wave to determine if the channel was really blocked. The pathological model of blockage of meridian (main) channels was successfully developed in 2007 [11] that brought a new starting point in Zhang's research. The upcoming study started from an occasional observation that two minipigs were found to appear gaseous distention in stomach several weeks after the LHRC along the stomach meridian was blocked by gel in the experiments in December 2008 and

March 2009, respectively. This phenomenon attracts the authors to observe intently the state of stomach and intestine after the stomach meridian was blocked so as to test the ancient theory of meridian-organ correlation.

## 2. Materials and Methods

**2.1. Animal Conditions.** The experiment was carried out on four batches of healthy pigs. The first batch contained four white piglets which were obtained from Beijing veterinary training center (weight: 10~12 kg, male, a month of age). The four pigs were divided into two groups each of which contained one experimental pig with gel injection and one control pig with saline injection. Each pair of pigs was housed simultaneously in a stainless steel cage ( $1.1 \times 1.0 \times 0.7$  m) separated by two parts using a fence (each part:  $1.1 \times 0.5 \times 0.7$  m, Figure 1(a)). The food and water were given three times a day.

The second, third, and fourth batches of experiments were carried on 12 Chinese black minipigs, 4 pigs in each batch, from Beijing Kexing Experimental Animal Breeding Center. The pigs were temporarily housed in the animal laboratory at  $20 \pm 2^\circ\text{C}$  with a relative humidity of  $50 \pm 10\%$  (license number: SYXK Beijing 2011-0014) in the Institute of Chinese Materia Medica, China Academy of Chinese Medical Science, for detailed observation. The cages have a size of  $1.1 \times 0.7 \times 0.8$  m and separated to two equal parts to house two pigs. The pig was feed twice a day with 150 g pig fed in the morning and 100 g in the evening and had accessed ad libitum to tap water. The light was simulated day and night by turning on the light at 8:00 am and turning off the light at 8:00 pm automatically. The experiment was approved by the Institutional Animal Care and Use Committee (license number: 120101) of Institute of Chinese Materia Medica, China Academy of Chinese Medical Sciences.

**2.2. Gel Preparation.** In the first batch of pigs, "Amazing" polyacrylamide hydrogel was got from Jilin Aodong medical material company in China. One gram of original Polyacrylamide hydrogel was diluted by mixing 5 mL of 0.9% saline which made it possible to be injected. As the gel could not be bought later, a new gel, "Macrolane", a stable hyaluronic acid from Uppsala company in Sweden, was used in the other pigs from batch 2 to batch 4. The gel has enough liquidity and can be injected directly into tissue without dilution. To see if the gel was still at the injected position after so many breeding days, a 10 mL gel package from Sweden was mixed by 0.3 mL 1% Alcian Blue (8 GX, Sigma Co., USA) for marking the gel from batch 2 to batch 4.

**2.3. Experimental Procedure.** The pigs were housed for about one week to adapt to the new environment. Fasting was carried out 12 hours before the operation. Then they were anaesthetized by pentobarbital sodium (30 mg/kg) intraperitoneally in batch 1 (4 piglets) and by injecting phenobarbital sodium solution (0.3 mg/kg) and Xylazine Hydrochloride Injection (0.1 mg/kg) intramuscularly in batches 2, 3, and 4 (12 pigs). The low impedance meridian lines on pigs were firstly measured by a low impedance meridian locator



FIGURE 1: The cages used to house the pigs. (a) Cage used in the first batch of pigs ( $1.1 \times 0.5 \times 0.7$  m for each pig). (b) Cage used in the other three batches of pigs ( $1.1 \times 0.7 \times 0.8$  m).

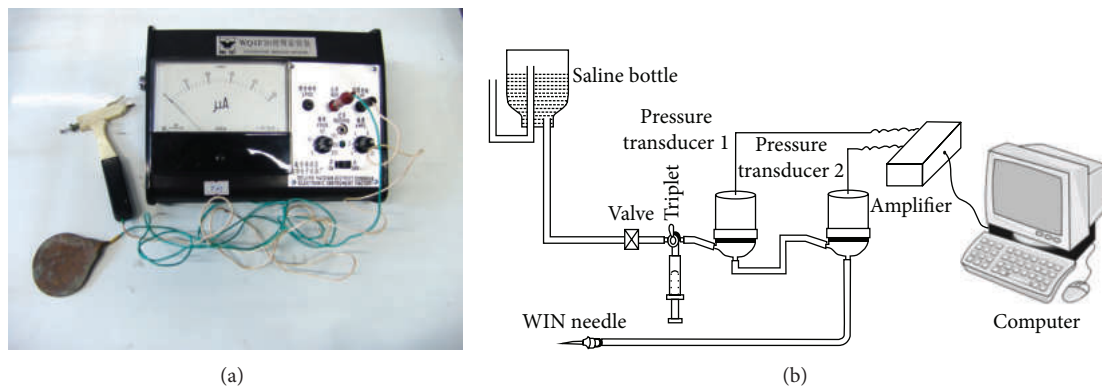

FIGURE 2: The equipment for measuring the meridians. (a) The WQ6F30 low impedance meridian locator. (b) The pressure differential continuous hydraulic resistance detector.

(type: WQ6F30, made in Donghua Company in China, Figure 2(a)) according to the previous study [12]. The LHRC along the stomach meridian was then measured by a pressure differential continuous HR detector (Figure 2(b)) which was described in detail in previous papers [10, 13]. After a low hydraulic resistance point (LHRP) was found in subcutaneous tissue along the stomach meridian, the needle was fixed on skin by glue and small amount of polyacrylamide hydrogel was slowly injected into the LHRP through the measured needle to block the channel. For the batches 1 to 3, totally six points were injected symmetrically on both sides with three on one side along the stomach meridian. One point was on leg close to Housanli (corresponding to Zusanli (ST36) on Human), the other was on hip at groin level, and another was on trunk at the third nipple level (Figures 3(a) and 3(b)). The injected volume on leg was 0.5 mL, 0.7 mL on hip, and 1.0 mL on trunk. In the fourth batch of pigs, the injected points were increased to eight, four at one side among which two points were at calf and thigh. The injected volumes were 0.5 mL, 0.5 mL, 0.7 mL, and 0.9 mL from calf to trunk (Figure 3(c)).

After the channel was blocked, the pig was sent back to the cage to feed for one to two months. The behavior was observed by a 24 hour monitor and the image was stored in computer and could be stored in anytime. Finally the pig was

anaesthetized again and the state of stomach and intestine was checked by exploratory laparotomy, watching and taking pictures using a digital camera (Nikon D5000, made in Japan). Then the stomach was cut open with scissors and inner surface was exposed to check if there was a gastric ulcer or perforation. The gel which was injected into the meridian channels was also checked during the final operation by uncovering the skin.

### 3. Results

**3.1. The States of Stomach and Intestine.** In the first pair of pigs among the first batch one month later, the pig whose stomach meridian was blocked by gel injection exhibited stomach distension (Figure 4(a)) where only small amount of liquid was found inside the stomach after opening it (Figure 4(b)) while the stomach is normal in the control pig (Figure 4(c)).

For the other pair of pigs among the batch 1 after one and a half months, the pig which was injected with gel exhibited serious abdominal distention (Figure 5(a)) and meteorism not only in stomach but small intestine as well (Figure 5(b)). The stomach was filled with about 2/3 gas and 1/3 liquid when watched in light (Figure 5(c)). The control pig which

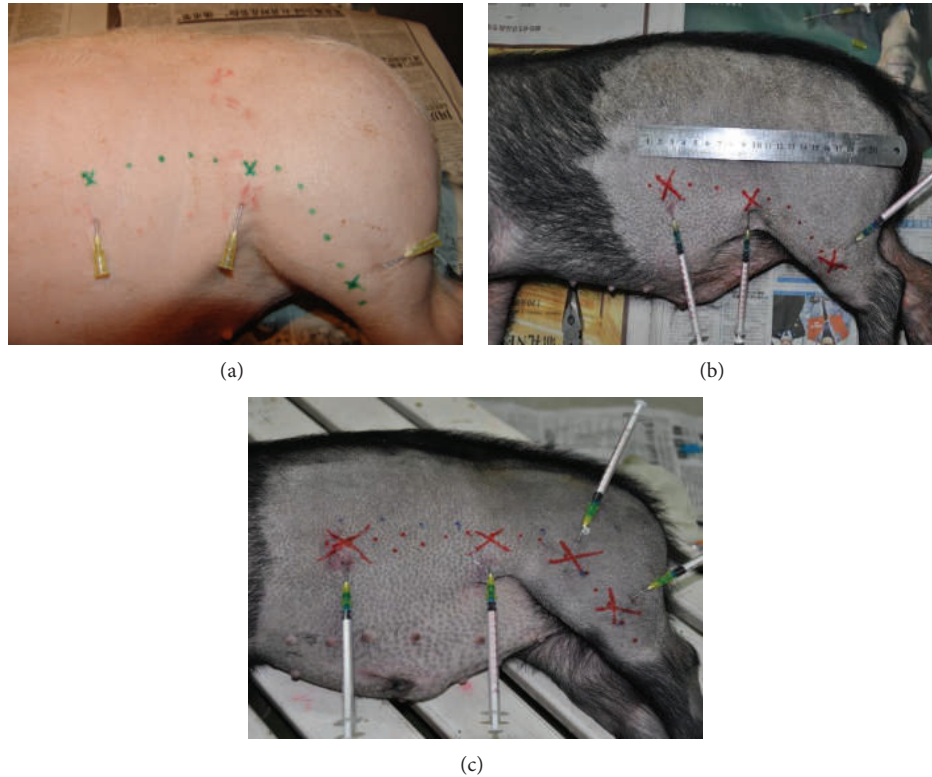

FIGURE 3: The positions of three injected points along one side of the stomach meridian in the first batch (a), second and third batches (b) and fourth batch (c) of pigs.

was injected with saline had a normal abdomen (Figure 6(a)), stomach, and intestine (Figure 6(b)).

The second batch of pigs was experimented from March to June in 2012 containing four minipigs which were divided two pairs with similar weights in each pair, containing an experimental pig and a control pig. The result showed obvious bloated parts at transverse colon (Figure 7(a)) and ileocecum (Figure 7(b)) but the stomach was normal in the first experimental pig after 72 days of gel injection while it was normal on both stomach and intestine in the control pig (Figure 7(c)) in a similar duration of 70 days after the operation.

For the experimental pig in the second pair, the stomach and small intestine were normal while two bloated parts were found on large intestine after 59 days of the injection (Figure 8(a)). The control pig had a normal stomach and intestine after the same duration (Figure 8(b)).

The third batch of pigs was experimented from August to September of 2012. In the first pair of pigs lasted for 52 days experimental pig and control pigs lasted for 55 days between the injecting date and operating date. The result showed a distension at one part of large intestine (Figure 9(a)). The bloated part obviously shrank when cutting it open with scissors (Figure 9(b)), indicating the existence of gas in it. The stomach and small intestine were normal in the control pig (Figures 9(c) and 9(d)).

In the second pair of pigs, the experimental pig exhibited similar situation to that of the experimental pig in the first pair. There was a striking shrink after releasing the gas by

cutting it open (Figures 10(a) and 10(b)) while the state of stomach and intestine was normal in the control pig (Figures 10(c) and 10(d)).

In the fourth batch of pigs was experimented from December 2012 to February 2013 eight points along the stomach meridian were blocked. The first pair of pigs lasted for 45 days experimental pig and control pig lasted for 47 days between the injecting date and operating date. After opening the abdominal cavity, it was found that the stomach was enlarged strikingly (Figure 11(a)). By lighting it, gas and liquid could be seen in the stomach (Figure 11(b)) which was similar to the situation in the first batch of experimental pig (Figure 5(c)). There was a normal state of stomach and intestine in the control pig (Figure 11(c)).

In the second pair of pigs, the experimental pig exhibited distensions both on small intestine (Figure 12(a)) and large intestine (Figure 12(b)). The size immediately shrank strikingly (Figure 12(c)) after the gas in small intestine was released by cutting open a hole with scissors. A quantitative measurement was made to show a size from 5 cm in diameter to 3.5 cm after releasing the gas in large intestine (Figure 12(d)). However, the stomach have not appeared obvious abnormal. The control pig in this pair was dead on the second day after the injection.

**3.2. The Examination of Inner Surface of Stomach.** The inner surfaces of stomach were examined after the operation to see if there was a gastric ulcer or perforation. No gastric ulcer



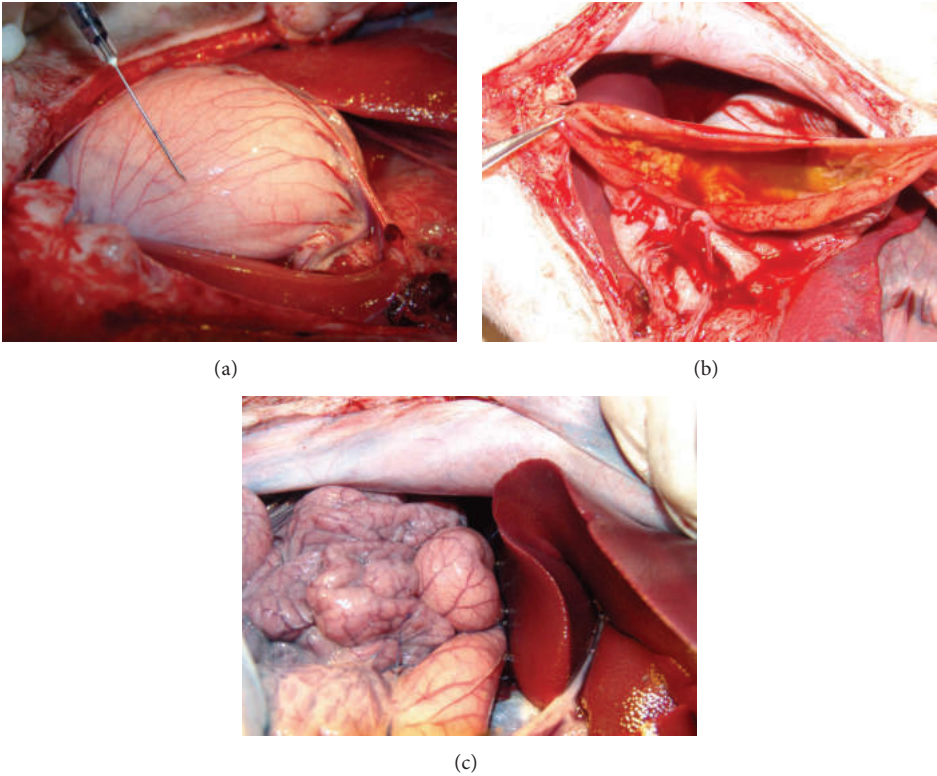

FIGURE 4: (a) A bloated stomach was observed on the third pig. (b) Only small amount of liquid was found in the stomach. (c) The stomach is normal in the control pig by saline injection.

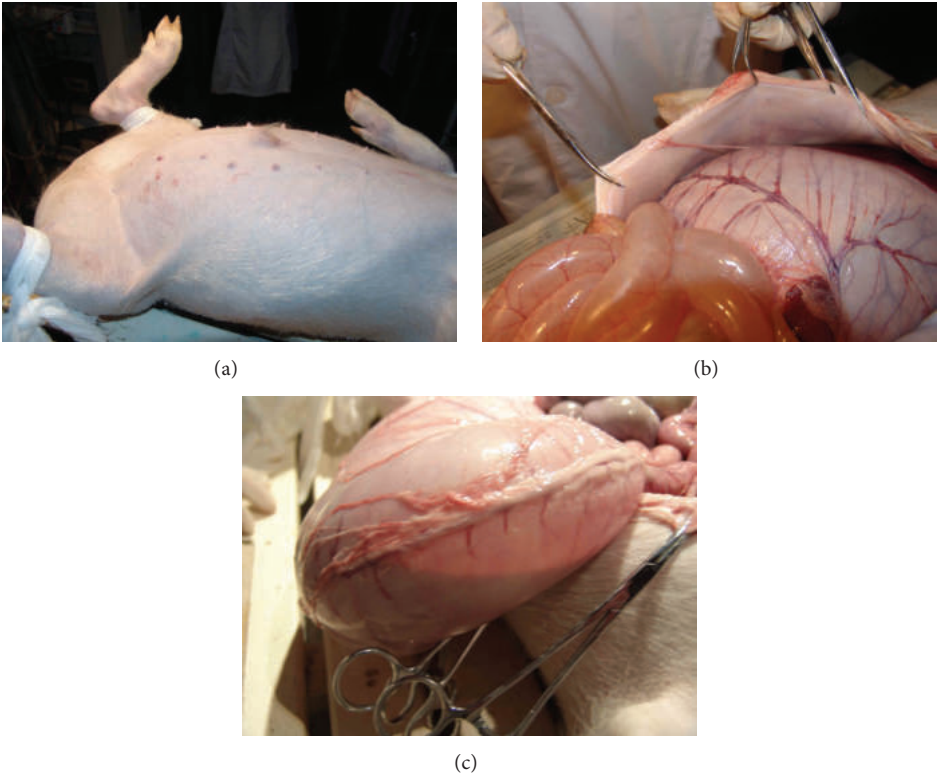

FIGURE 5: The pig exhibited bloated abdomen (a) and bloated stomach and intestine (b). (c) The stomach was filled with gas and water.

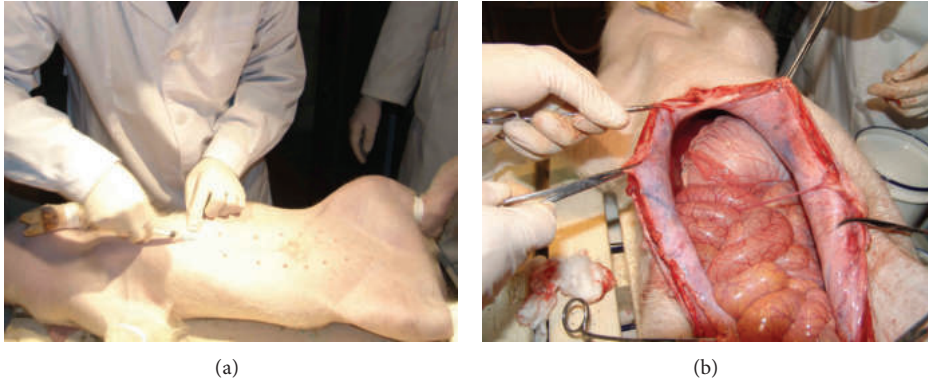

FIGURE 6: The control pig exhibited normal abdomen (a) and normal stomach and intestine (b).

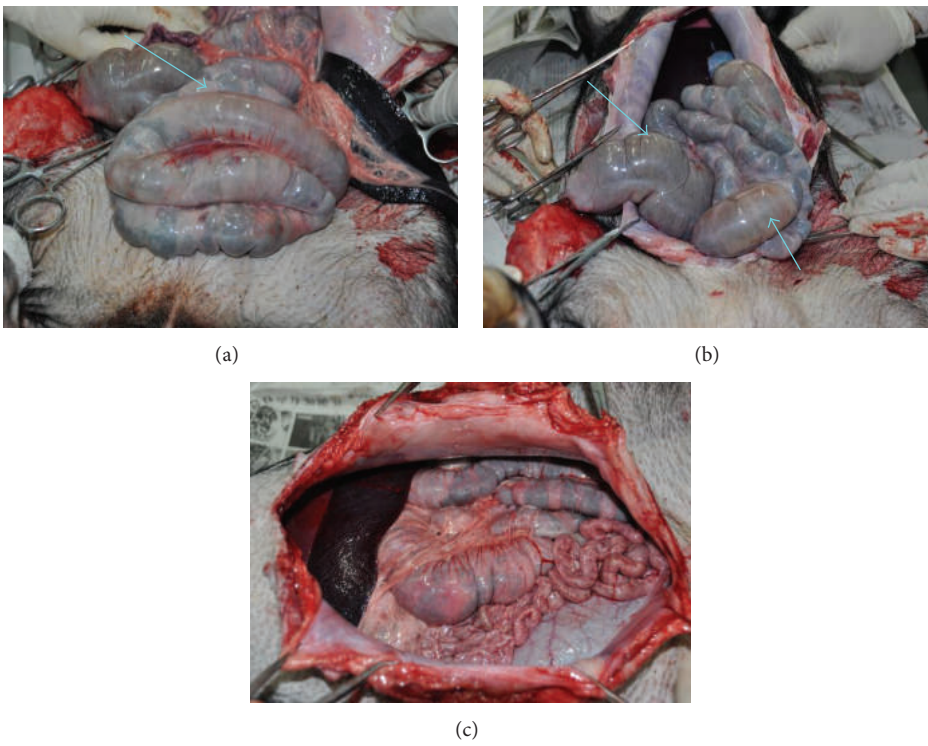

FIGURE 7: The large intestine at transverse colon (a) and ileocecum (b) exhibited bloated state (↑) in the first experimental pig (batch 2). (c) The control pig showed normal state of stomach and intestine.

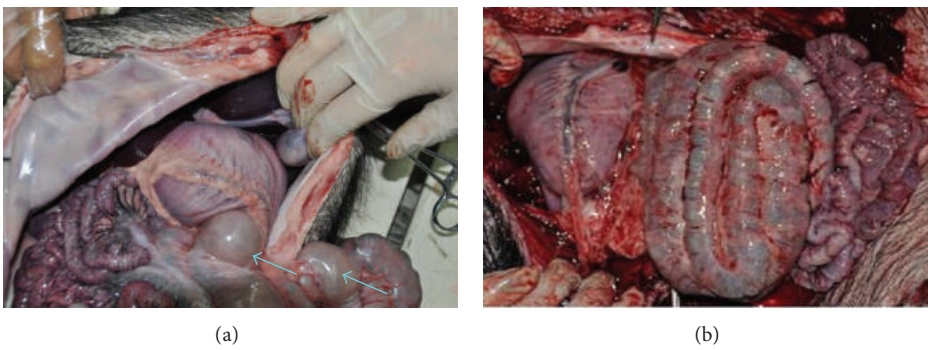

FIGURE 8: (a) In the experimental pig of second pair, there were two parts (↑) on large intestine appear bloated state. (b) There was normal state on stomach and intestine in the control pig.

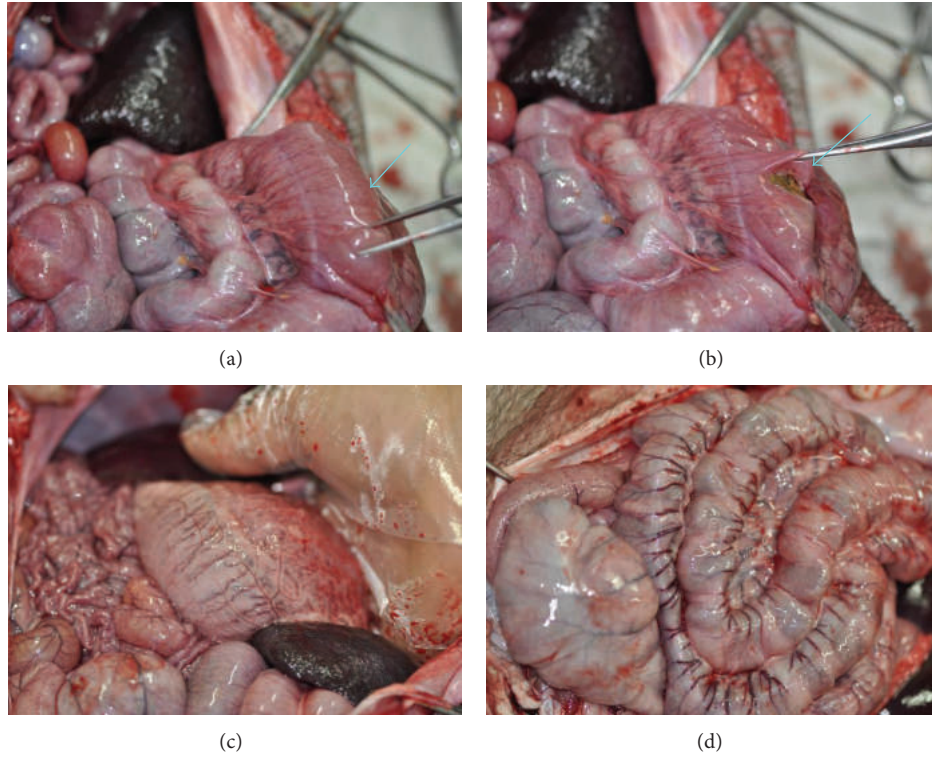

FIGURE 9: In the experimental pig of the first pair (batch 3), there was a bloated part on large intestine (a) and it shrank when cutting it open with scissors (b). The control pig showed normal state of stomach (c) and intestine (d).

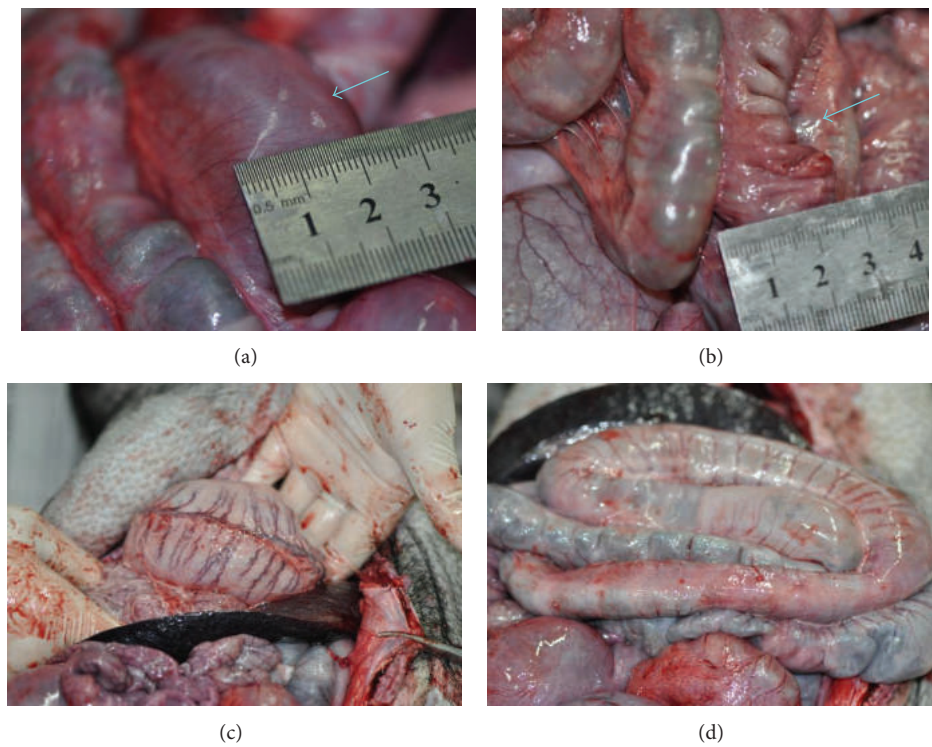

FIGURE 10: In the experimental pig of second pair (batch 3), there was a flatulence on large intestine (a) and there was strikingly shrink after releasing the gas in it (b). There was normal state in stomach (c) and intestine (d) in the control pig.

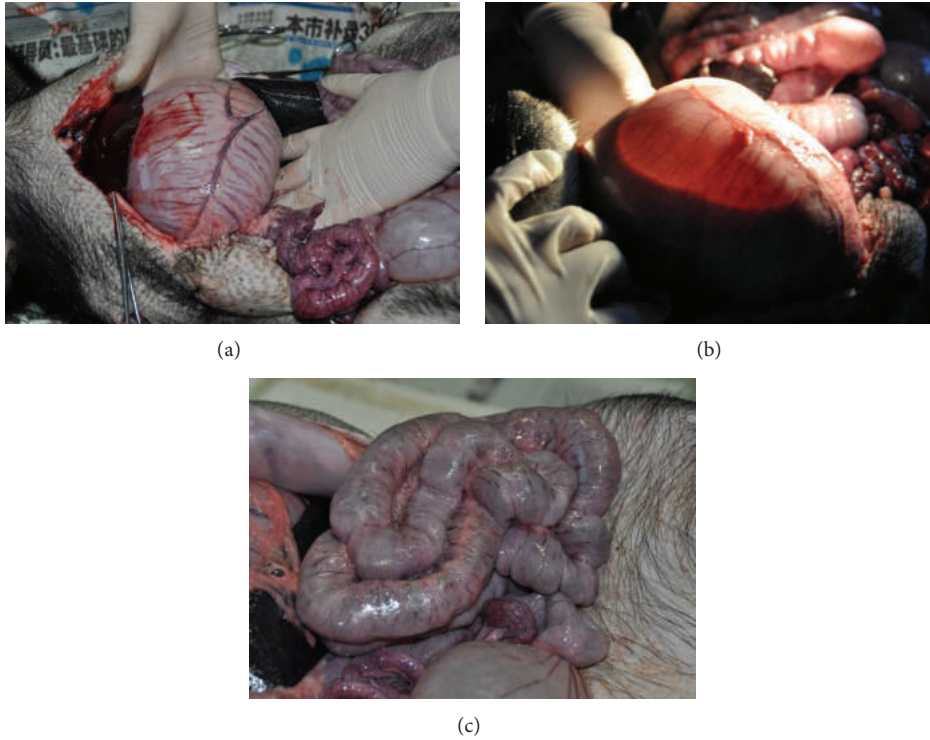

FIGURE 11: In the experimental pig of the first pair (batch 4), there was a bloated stomach (a). Gas and water were observed in the stomach (b). There was a normal state in stomach and intestine (c) in the control pig.



FIGURE 12: In the experimental pig of the second pair (batch 4), there were bloated parts (↑) on small intestine (a) and large intestine (b). The intestine shrank strikingly (↑) after the inner gas was released by cutting a small hole with scissors ((c), (d)).

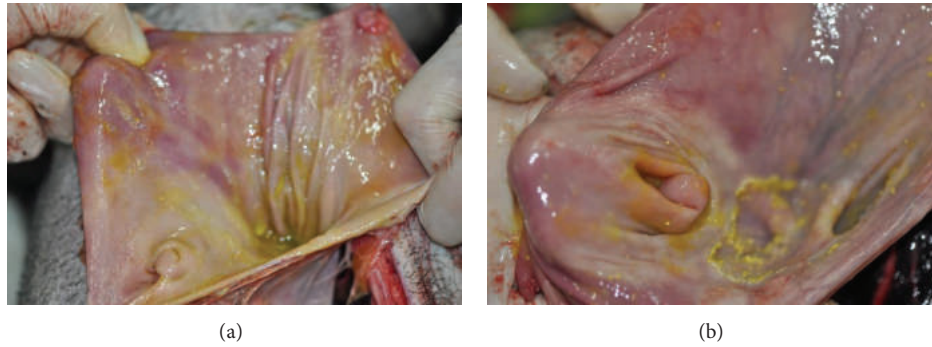

FIGURE 13: The inner surface of stomach which showed no gastric ulcer or perforation both in an experimental pig (a) and a control pig (b).

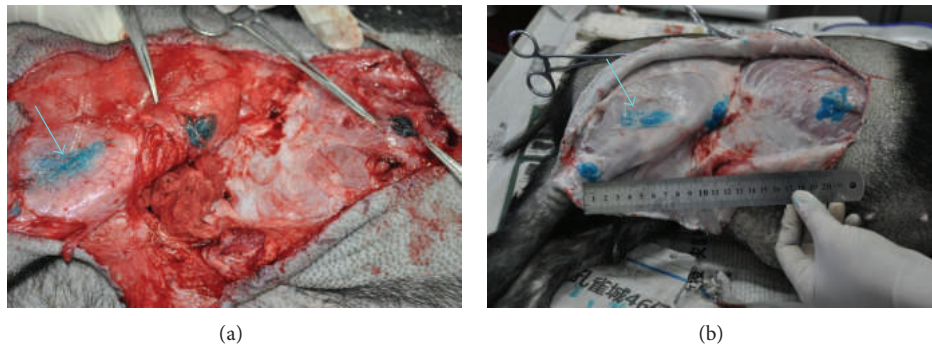

FIGURE 14: The locations of injected gel along the stomach meridian. (a) Three points were blocked on one side of pigs. (b) Four points were blocked on one side of pigs. The gel at thigh diffused along the stomach meridian (↑).

or perforation was found in all the pigs no matter what was injected into the meridian. The inner surface of stomach was smooth and fresh. The inner surfaces of stomach in a pair of pigs were shown in Figures 13(a) and 13(b).

**3.3. The Locations of Injected Gel.** The locations of injected gel were checked by uncovering the skin around the injecting points. The gel with blue color could be found in every injected points. The gel on thigh above Zousanli (ST36) diffused a short distance (2–5 cm) along the stomach meridian in all the six pigs while the gel stayed at the injected points or just a slight diffusion (3 cases) at the points on trunk (Figure 14(a)). In the fourth batch of pigs four points along one side of stomach meridian were blocked; the gel on calf can stay at the point without diffusion (Figure 14(b)).

## 4. Discussion

The results showed a coincident pathological change in stomach or intestine after LHRC along the stomach meridian was blocked.

**4.1. The Stomach Meridian and the Related Internal Organs.** Most studies on correlation between meridians and internal organs were carried out through observing the organ response when stimulating a meridian point or observing the changes along a meridian when the pathological model of a related organ was developed. This is the first time to study

the pathological chronic influence of meridian on the related organs which has obvious importance to understand the deep mechanism of diseases and the principle of health.

Stomach meridian is one of the longest meridians in our body which relates not only stomach but large intestine and small intestine according to the chapter of Ben Shu in Yellow Emperor's canon of internal medicine. Both upper sea point of large intestine Shangjuxi (ST37) and lower sea point of small intestine Xiajuxi (ST39) locate on stomach meridian. So an overall observation of stomach, small intestine, and large intestine was taken in the blocking model of the stomach meridian.

**4.2. The Observation of Pathological State of Organs.** Necropsy is a common method to test the pathological state of organs. The size or volume is often used to examine the organ state in veterinary pathological anatomy [14]. But it is difficult to get quantitative measurements as the shape of organs is very irregular. We tried to measure the diameter of intestine by a ruler but found it very difficult. So the judgment was made by eyes in the most cases and clear photos were collected by CCD camera as much as possible.

An abnormal distension of stomach or intestine was defined when large amount of gas exists inside. It is usually determined not only by the size or volume but the color, transparency, curvature, and elasticity. A real distension of intestine with a lot of gas often exhibits yellow or grey color with transparent wall which is soft and elastic. We developed

a method to test the contained gas by cutting a hole to release the gas and taking pictures again in the later experiments. The usual situation in pathological stomach is abnormally much liquid and gas in the stomach. We also developed a simple method by lighting the stomach to show the volume of gas and liquid inside the stomach. As the observation took a long time and the conditions and materials were improved gradually, it is hard to keep constant conditions in all the pigs during the whole study. However, we kept each observation containing one pig with gel injection and the other pig with saline injection with the same conditions so as to let them comparable.

The results showed that all the 8 pigs, no matter white or black, had a problem on stomach or/and intestine with a bloated state where there were mostly gas and/or liquid (in stomach) after injecting gel into the stomach meridian while the states of stomach and intestine were basically normal in 7 control pigs in which the same amount of saline was injected at the same points. The result illustrated that the exhibited pathological state in pigs was not caused by the operation and the injection itself but the content of injection. No gastric ulcer or perforation was found in all the pigs which implied that the pathological change is mainly functional during the observed period of two months. But we could not get a conclusion that the blockage of meridian can only cause a functional influence on the internal organ. After an enough long time, a functional pathological change may develop an organic change which needs to be verified in later experiments.

*4.3. The Technique of Blocking Meridian.* The technique of blockage is often used in biology to see if a pathway or signal really exists to cause an effect. A transient blockage of meridian by mechanical pressure has also been used in meridian study for a long time in Hu XL's team in Fujian province. The results showed a break of acupuncture effects when a mechanical pressure was applied on related meridian line [15, 16]. But to observe a long-term influence of meridian blockage, mechanical pressure is not convenient. The main component of hydrogel is hyaluronic acid which was found to have a very high hydraulic resistance by Scott et al. [17] and Coleman et al. [18]. When the gel was injected into the tissue, it will be filled into the tiny pores of the tissue, resisting the flow of interstitial fluid along LHRC and breaking the transmission of chemical signals along the channel. This blocking effect is similar to the mechanical pressure which can shrink the space of gaps in the interstitium while the gel can block the channel for a long time as long as it stays in the tissue. However, as LHRC is a porous medium channel which is opened to any directions, it is hard to be totally blocked like blocking a blood vessel. The interstitial fluid can still flow round the injected gel and continue to move while the flux will be weakened. In the phenomenon of propagated sensation along meridian (PSM), the sensation induced by acupuncture or acupress can move around a scar on the meridian [19] which illustrates the porous medium characteristics of the channel. Therefore three or four points were blocked on each side of stomach meridian to enhance the blocking effect. As the blocking effect will be accumulated following the time,

an average blocking time of 49 days was estimated from previous experience that most pigs have not exhibited a bloated state of stomach or intestine after stomach meridian was blocked by gel in a period from two to four weeks and the earliest pig was found to have the problem 41 days after the blockage. But to verify the relationship quantitatively between the days of undergoing blocking model and the pathological degree, more pigs should be observed.

The located situation of gel in meridian channel is also a factor to influence the pathological effect. In the early experiment of two white pigs (batch 1) and even earlier two black pigs which were bred in a smaller cage, the main pathological changes happened on stomach while it rarely appeared in the later pigs which lived in a bigger cage. They had more space to move their limb that might cause a diffusion of gel at thigh (Figure 13) and diminish the blocking effect. The diffusion on thigh level was found on the second and third batches of pigs. After this was noticed, we added a new injecting point at calf level on the fourth batch of pigs and found that the gel could stay there without a diffusion; at the same time there were a distension on stomach in the first experimental pig and a distension on small intestine in the second experimental pig which had not been found in batch 2 and batch 3. So it was impressive that the blocking degree and allocation can influence the bloated position in viscera.

*4.4. The Mechanism of Interaction between Meridians and Organs.* How does a meridian influence an internal organ? The observed gastrointestinal flatulence in pigs is in coincidence with "abdominal distension" in the symptoms of stomach meridian. In the view of Western medicine, gastrointestinal flatulence is a common problem on human which is induced mainly by the abnormal movement of stomach and intestine. The movements are influenced by food, humoral signals such as enterogastrone, and neural signals from enteric nervous system or central nerve system. Earlier study showed a somatic projection from Zusanli to nucleus solitaries which control the movement of stomach and intestine [20]. Zhou et al. found, when giving an electric acupuncture at Zusanli (ST36), Tianshu (ST25), and Liangmen (ST21) on the stomach meridian, the migrating motor complex (MMC) was enhanced [21]. It seems that there is an interaction between meridian and nerve system. As an extracellular fluid channel, how does the channel influence the activity of nerve? In 1986, a new hypothesis was put forward by Agnati et al. [22] that the interactions between neurons are not only through the neural fibers and synapse but also through extracellular space which was named volume transmission (VT). Several review articles concerning VT were published recently [23, 24], indicating the hypothesis has been accepted. Fuxe further pointed out that VT may also happen in peripheral tissue via interstitial fluid transmission [25] which relates to Zhang's discovery of LHRC [10]. The PSM phenomenon which tightly relates to meridians can be understood through VT along LHRC [26]. The idea and the new findings in this work imply that LHRC is the essence of meridians at least in part. Assuming the activity of stomach and intestine was controlled by a series of autonomic nerves and these nerves can interact through LHRC along meridians, whenever LHRC is blocked,

the interaction becomes weak, leading to a difficulty of harmonious motion along stomach and intestine. Therefore an accumulation of gas happens gradually in stomach or intestine.

This is just a preliminary observation to show the existence of long-term pathological influence on internal organs from peripheral meridians. More controlled experiments should be done to see if the stomach meridian is specific to cause the pathological state on stomach and intestine.

## 5. Conclusion

The blockage of LHRC along the stomach meridian can influence the state of stomach and intestine, leading to a pathological distension on stomach or/and intestine. But we could not get a conclusion that the blockage of meridian channel can only cause a functional distention without organic changes as the observing time is still short.

## Conflict of Interests

All the authors declare that they have no conflict of interests.

## Acknowledgment

This work was supported by a Grant (no. 30840101) from National Natural Science Foundation of China.

## References

- [1] D. Li, *Meridianology*, Shanghai Science and Education Press, Shanghai, China, 1995.
- [2] B. Ji, X. H. Li, and L. F. Zhang, "Correlation between acupoints and Zang-fu organs based on clinical trials," *Chinese Acupuncture & Moxibustion*, vol. 32, no. 4, pp. 382–384, 2012.
- [3] B. Wang (Tang Dynasty), "Jue Qi," in *Yellow Emperor's Canon of Internal Medicine: Ling Su*, Englished by L.S. Wu, Q. Wu, p. 645, China Science & Technology Press, Beijing, China, 1997.
- [4] B. Wang (Tang Dynasty), "Wu Long Jin Ye Bie," in *Yellow Emperor's Canon of Internal Medicine: Ling Su*, Englished by L.S. Wu, Q. Wu, p. 658, China Science & Technology Press, Beijing, China, 1997.
- [5] A. C. Guyton, K. Scheel, and D. Murphree, "Interstitial fluid pressure. III. Its effect on resistance to tissue fluid mobility," *Circulation Research*, vol. 19, no. 2, pp. 412–419, 1966.
- [6] K. Aukland and R. K. Reed, "Interstitial-lymphatic mechanisms in the control of extracellular fluid volume," *Physiological Reviews*, vol. 73, no. 1, pp. 1–78, 1993.
- [7] J. R. Levick, "Flow through interstitium and other fibrous matrices," *Quarterly Journal of Experimental Physiology*, vol. 72, no. 4, pp. 409–437, 1987.
- [8] M. A. Swartz and M. E. Fleury, "Interstitial flow and its effects in soft tissues," *Annual Review of Biomedical Engineering*, vol. 9, pp. 229–256, 2007.
- [9] W. B. Zhang, *What are the Meridians*, China Science & Technology Publishing House, Beijing, China, 1997.
- [10] W. B. Zhang, Y. Y. Tian, H. Li et al., "A Discovery of low hydraulic resistance channel along meridians," *Journal of Acupuncture and Meridian Studies*, vol. 1, no. 1, pp. 20–28, 2008.
- [11] Y. Xu, W. Zhang, Y. Tian et al., "Preliminary observation of the blocking effect produced by injecting polyacrylamide hydrogel on low hydraulic resistance channel along meridian," *Journal of Biomedical Engineering*, vol. 26, no. 4, pp. 776–779, 2009.
- [12] Z. X. Zhu, R. X. Zhang, R. M. Xu et al., "Localization of the line of latent propagated sensation along channel of lung and its low impedance characteristics," *Agopuntura e Tecniche di Terapia Antalgica*, vol. 3, no. 1, pp. 13–17, 1985.
- [13] W. B. Zhang, Y. Y. Tian, and H. Li, "A method to measure hydraulic resistance of subcutis continuously and the study of low hydraulic resistance points," *ACTA Biophysica Sinica*, vol. 14, no. 2, pp. 373–379, 1998.
- [14] D. X. Ma, *Experimental Technique of Veterinary Pathological Anatomy*, Chemical Industry Press, Beijing, China, 2009.
- [15] B. Wu, X. Hu, J. Xu, B. Yang, W. Li, and B. Li, "Localization of the meridian track over body surface by the method of blocking the acupuncture effect with mechanical pressure," *Acupuncture & Electro-therapeutics Research*, vol. 18, no. 2, pp. 132–136, 1993.
- [16] X. Y. Xu, X. L. Hu, and B. H. Wu, "The influence to the PO<sub>2</sub> at deep tissue along meridians by mechanical pressure during acupuncture," *Acupuncture & Electro-therapeutics Research*, vol. 25, no. 4, pp. 276–279, 2000.
- [17] D. Scott, P. J. Coleman, R. M. Mason, and J. R. Levick, "Glycosaminoglycan depletion greatly raises the hydraulic permeability of rabbit joint synovial lining," *Experimental Physiology*, vol. 82, no. 3, pp. 603–606, 1997.
- [18] P. J. Coleman, D. Scott, A. Abiona, D. E. Ashurst, R. M. Mason, and J. R. Levick, "Effect of depletion of interstitial hyaluronan on hydraulic conductance in rabbit knee synovium," *Journal of Physiology*, vol. 509, no. 3, pp. 695–710, 1998.
- [19] S. F. Jiao, "Preliminary study on propagated sensation along meridians," in *Sensitive people on Meridians—Collection of the Studies on Propagated Sensation along Meridians*, p. 178, People's Medical Publishing House, Beijing, China, 1st edition, 1979.
- [20] S. Y. Xi and Z. L. Tao, "The research on the afferent pathway of 'ZUSANLI'," *Acupuncture & Electro-therapeutics Research*, vol. 7, no. 1, pp. 66–69, 1982.
- [21] L. Zhou, L. J. Wang, T. Y. Yun et al., "The influence of electric acupuncture to acupoints of the stomach meridian on the migrating motor complex and release of braingut peptide in dogs," *Chinese Science Bulletin*, vol. 45, no. 22, pp. 2419–2426, 2000.
- [22] L. F. Agnati, K. Fuxe, M. Zoli et al., "A correlation analysis of the regional distribution of central enkephalin and  $\beta$ -endorphin immunoreactive terminals and of opiate receptors in adult and old male rats. Evidence for the existence of two main types of communication in the central nervous system: the volume transmission and the wiring transmission," *Acta Physiologica Scandinavica*, vol. 128, no. 2, pp. 201–207, 1986.
- [23] K. Fuxe and L. F. Agnati, "Cell-Cell communication through the extracellular space," in *Encyclopedia of Neuroscience*, vol. 2, pp. 655–664, Elsevier, 2013.
- [24] K. Fuxe, A. Dahlström, M. Höistad et al., "From the Golgi-Cajal mapping to the transmitter-based characterization of the neuronal networks leading to two modes of brain communication: wiring and volume transmission," *Brain Research Reviews*, vol. 55, no. 1, pp. 17–54, 2007.

- [25] K. Fuxe, A. B. Dahlström, G. Jonsson et al., “The discovery of central monoamine neurons gave volume transmission to the wired brain,” *Progress in Neurobiology*, vol. 90, no. 2, pp. 82–100, 2010.
- [26] W. B. Zhang, Y. Zhao, and K. Zhao, “Understanding propagated sensation along meridians by volume transmission in peripheral tissue,” *Chinese Journal of Integrative Medicine*, vol. 19, no. 5, pp. 330–339, 2013.



## Research Article

# Study on the Dynamic Compound Structure Composed of Mast Cells, Blood Vessels, and Nerves in Rat Acupoint

Luo Mingfu, Dong Xiaotong, Song Xiaojing, Jiang Jin, Zhann Jinling, and Han Ying

*Institute of Acupuncture and Moxibustion, China Academy of Chinese Medical Sciences, Beijing 100700, China*

Correspondence should be addressed to Luo Mingfu; [psy\\_lmf@yahoo.com.cn](mailto:psy_lmf@yahoo.com.cn)

Received 15 April 2013; Accepted 7 June 2013

Academic Editor: Wei-bo Zhang

Copyright © 2013 Luo Mingfu et al. This is an open access article distributed under the Creative Commons Attribution License, which permits unrestricted use, distribution, and reproduction in any medium, provided the original work is properly cited.

**Background.** Circulation system, immunity system, and nervous system have a close relationship with meridian phenomenon. However, there is still lack of the results of dynamic changes of these structures in acupoint. The aim of this study is to explore the interrelationship by composite staining techniques. **Methodology/Principal Findings.** Twenty rats were separated into electroacupuncture group (EA) and control group (Con) randomly. In EA group, the Zusanli and Weishu were stimulated with the 0.1 mA for 25 min. The tissue of these acupoints was double-stained with acetylcholinesterase and Toluidine blue. The compound structure of mast cells, nervous fibers, and mast cells in the acupoint was observed. **Conclusions/Significance.** The blood vessels, mast cells and acetylcholinesterase responded nerves were clearly observed in acupoint tissues. EA can result in the mast cell recruitment and migration along the blood vessels and nervous bundle, which conformed the dynamic compound structure and played important roles in acupuncture.

## 1. Introduction

Previous study has proved the evidence that nervous system [1, 2], blood vessels [3], and mast cells [4–6] have a relationship with acupuncture. However, there is still lack of evidence from the histology that these parts work as a whole. In this study, we find a new histological method with which we can simultaneously display the nervous tissue, the blood vessel, and mast cells in the same section of acupoint.

## 2. Method

**2.1. Animal and Material.** Twenty male Wistar rats were kept in an animal house maintained with a 12-hour light-dark cycle and were given free access to food and water. The weight of the rats was 120–150 g. The other instrument and materials are as follows: the vulcanization acetylcholine iodized salt (sigma-Aldrich, USA), Toluidine Blue O (Amresco, USA), constant cold box slicer (Thermo Fisher Scientific, UK).

**2.2. Interventions and Histological Stain.** The rats were separated into control group (Con) and electroacupuncture group

(EA) randomly, in EA group, left Zusanli (ST36) and Weishu (BL21) were stimulated with electroacupuncture machine, and the parameters are 0.1 mA, 2/15 Hz, for 25 min every day, and the duration is 2 days. In Con group, there have been no interventions. The tissue samples including skin, subcutaneous tissue, and muscle tissue were collected from Zusanli and Weishu acupoint (size: 1 cm × 1 cm × 0.4 cm) in both EA and Con groups. Then the 15 μm thickness section was prepared for double staining with Copper ferrocyanide method and acetylcholinesterase stain method. Finally, the section was dyed in 1% Toluidine blue solution for 15 second. The tissue section was observed with microscope.

## 3. Result

Under the microscope, the small and medium-sized artery in Zusanli acupoint area was longitudinal distribution along the limb long axis; the medium-sized artery in the Weishu acupoints was longitudinal distribution, too. However, the small artery and vein in the Weishu area were mutual anastomosis with each other and form the trunk long axis blood network. The blood vessel layers can be identified,

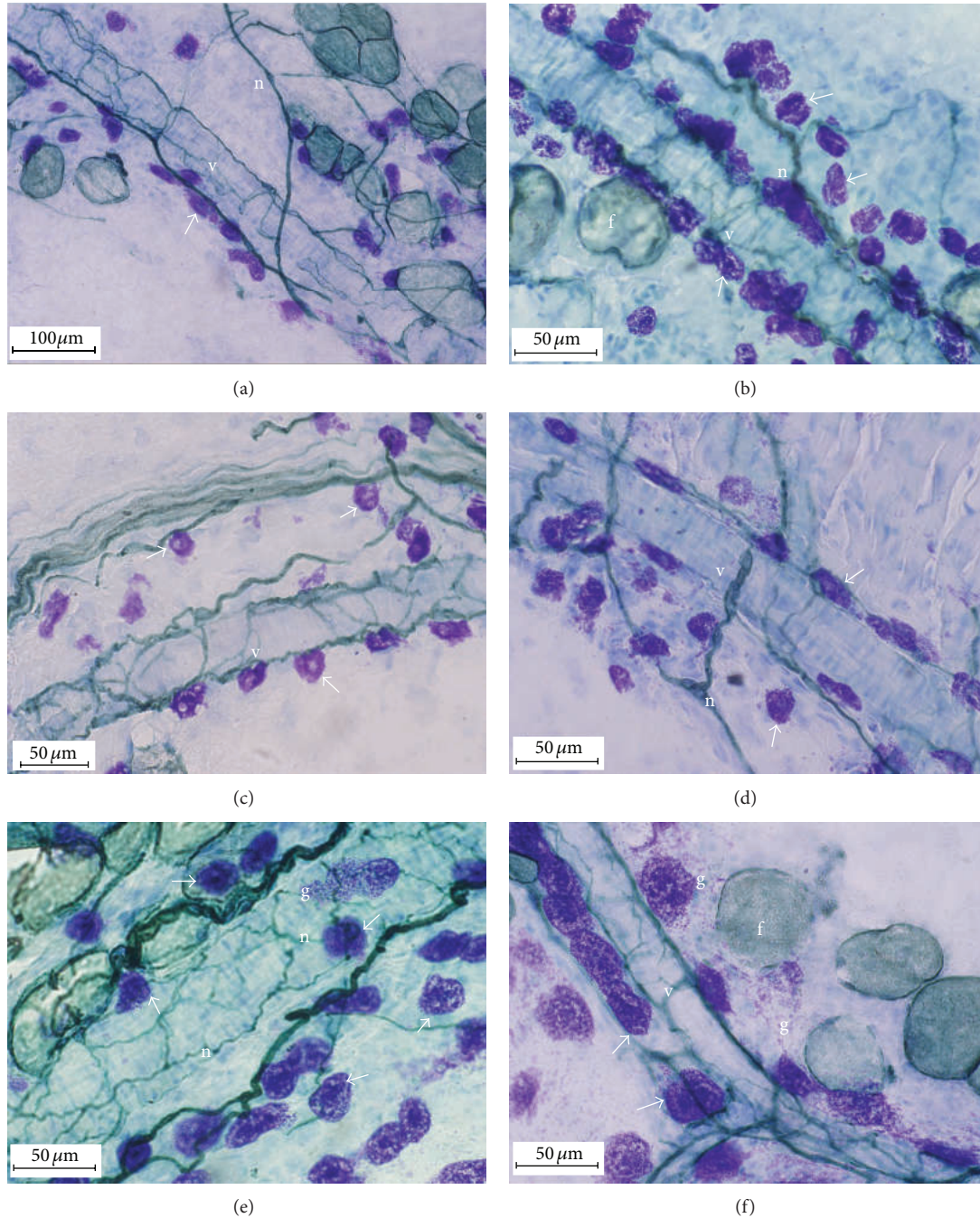

FIGURE 1: (a) Weishu acupoint in Con group. (c) Zusanli acupoint in Con group. (b) Weishu acupoint in EA group. (d) Zusanli acupoint in EA group. (e) Weishu acupoint in EA group. (f) Weishu acupoint in EA group. ✓: MC; v: blood vessels; f: fat tissue; n: Acher nerve fibers; g: particulate matter released from the MC.

with the smooth muscle distributed in the wall of the small arteries (diameter, 20–200  $\mu\text{m}$ ) and the capillary tortuosity into the group. Cholinesterase-positive nerve fibers (Acher) with different thickness were clearly visible, surrounding the blood vessels in the arterial wall, which has the close relationship with the vascular smooth muscle (Figures 1(a) and 1(e)). There are thick cholinesterase-positive nerve fibers near the vascular form into the sparse network. In the dermis,

subcutaneous and muscle tissues of the acupoint area, the different sizes and numbers of MC could be found. Most of these MCs array along the small blood vessels and neural network with a special sequence and come into a close contact with each other (Figures 1(a), 1(b), and 1(c)). Finally, a compound band structure constituted by MCs, blood vessels, and nervous fibers will be found in the acupoints (Figures 1(a)–1(f)). In the point area of Con group, the number

of composite banded structure constituted by blood vessels, nerves, and MC is less sparse arrangement (Figure 1(c)). In the EA group, MC number and degranulation number of MC increased in the acupoint area (Figures 1(d) and 1(f)). In addition, EA stimulation not only resulted in MC's migration and recruitment around the blood vessels, but also caused the MC cell body increases and deformation movement, which provided the space and path for MC's array in a special order along the nervous blood vessels network. As a result, the space-time function structure constituted by the MC + blood vessels + nervous fibers obviously increased in the acupoint, and this special structure will extend to the adjacent acupoint area (Figure 1(b)).

#### 4. Discussion

Previous research suggested that acupoint is relatively dense structures such as nerves [7], blood vessels, lymphatic vessels [8], and tissue space area [9]; however, there is lack of morphological evidence of whether or how to contact with each other. This study indicated that in the acupoint, the MCs, vascular vessels, and nervous fibers formed the space-time composite strip structure, and the internal components of this strip structure have the close and reciprocity correlation. This strip structure is not limited to the acupoint area but extended to the adjacent area, which forms the web channel for signal transformation between somites [10]. This phenomenon can be explained by the traditional meridian theory.

Under the action of acupuncture, MC was migrated and recruited in the acupoint and meridians. As a result, the active components which come from vessels, nervous fibers, immunity system, and endocrine system interacted with each other to form a functional coupling structure. According to the properties of this composite structure and correlation with the acupuncture meridians effect, we defined this special structure as mobile cell communication web system.

Mobile cell communication web system mainly consists of the vascular network subsystem, neural network subsystem, the immune network subsystem, and the channel network subsystem. The vascular network subsystem is the source of human activity which collected the materials, energy, information, and also the original ditch of mobile cells. It is also the metabolism foundation of tissues and cells and stable physiological functions.

Neural network subsystem is an important information control system, linked to various organs through different nerve endings. For example, different caliber blood vessels closely related to the different types of neural endings which had different neurotransmitters and peptides regulated the flow of the peripheral blood circulation precisely [11] then influenced the transport and distribution of body fluid and took part in the stress response and nerve-endocrine-immunity procedure.

Mobile cell subsystem is an active subsystem, which plays an important role in cell-cell or tissue-tissue communication through cell migration. In particular, the increased number of mobile cells or particle matters released from the mobile cell reflected the correlation and dynamic function of these subsystems.

Therefore, the mobile cell subsystem is an important order parameter in switching and regulating the acupuncture effect. The mobile cells take part in the cascade reaction of acupuncture through multi-channel and multi-target.

After acupuncture, the MC number increased in the fascial spaces or channel spaces around the blood vessels. The volume of MC was enlarged, and the large amount active compound was released; as a positive feedback reaction, the channel spaces gradually enlarged. The enlarged tissue space is a special functional pathway which will be beneficial for MCs migration in a special order, and finally, these special spaces formed the tissue channel as an important exchange pathway for material, information, and energy [12, 13].

#### Disclosure

No competing financial interests exist.

#### Acknowledgment

This research was supported by the National Natural Science Foundation of China (Project no. 30973797).

#### References

- [1] Z.-Q. Zhao, "Neural mechanism underlying acupuncture analgesia," *Progress in Neurobiology*, vol. 85, no. 4, pp. 355–375, 2008.
- [2] M. Silberstein, "Do acupuncture meridians exist? Correlation with referred itch (mitemphi ndung) stimulus and referral points," *Acupuncture in Medicine*, vol. 30, no. 1, pp. 17–20, 2012.
- [3] T.-C. Kuo, C.-W. Lin, and F.-M. Ho, "The soreness and numbness effect of acupuncture on skin blood flow," *American Journal of Chinese Medicine*, vol. 32, no. 1, pp. 117–129, 2004.
- [4] Y. Shi, L. Qi, J. Wang et al., "Moxibustion activates mast cell degranulation at the ST25 in rats with colitis," *World Journal of Gastroenterology*, vol. 17, no. 32, pp. 3733–3738, 2011.
- [5] W. Yao, Y. Li, and G. Ding, "Interstitial fluid flow: the mechanical environment of cells and foundation of meridians," *Evidence-Based Complementary and Alternative Medicine*, vol. 2012, Article ID 853516, 9 pages, 2012.
- [6] D. Zhang, A. Spielmann, L. Wang et al., "Mast-cell degranulation induced by physical stimuli involves the activation of transient-receptor-potential channel TRPV2," *Physiological Research*, vol. 61, no. 1, pp. 113–124, 2012.
- [7] F. Kagitani, S. Uchida, H. Hotta, and Y. Aikawa, "Manual acupuncture needle stimulation of the rat hindlimb activates groups I, II, III and IV single afferent nerve fibers in the dorsal spinal roots," *Japanese Journal of Physiology*, vol. 55, no. 3, pp. 149–155, 2005.
- [8] X. F. Lou and S. H. Jiang, "Anatomical characters and classification of acupoint," *Zhongguo Zhen Jiu*, vol. 32, no. 4, pp. 319–323, 2012.
- [9] G.-J. Wang, M. H. Ayati, and W.-B. Zhang, "Meridian studies in China: a systematic review," *JAMS Journal of Acupuncture and Meridian Studies*, vol. 3, no. 1, pp. 1–9, 2010.
- [10] W.-B. Zhang, Y.-Y. Tian, H. Li et al., "A discovery of low hydraulic resistance channel along meridians," *JAMS Journal of Acupuncture and Meridian Studies*, vol. 1, no. 1, pp. 20–28, 2008.

- [11] I. L. Gibbins and J. L. Morris, "Sympathetic noradrenergic neurons containing dynorphin but not neuropeptide Y innervate small cutaneous blood vessels of guinea-pigs," *Journal of the Autonomic Nervous System*, vol. 29, no. 2, pp. 137–149, 1990.
- [12] H.-Y. Li, J.-F. Yang, M. Chen et al., "Visualized regional hypodermic migration channels of interstitial fluid in human beings: are these ancient meridians?" *Journal of Alternative and Complementary Medicine*, vol. 14, no. 6, pp. 621–628, 2008.
- [13] W. Zhang, F. Zhuang, Y. Tian, and H. Li, "A simulating study of biophysical features along meridians on a gel model," *Sheng Wu Yi Xue Gong Cheng Xue Za Zhi*, vol. 18, no. 3, pp. 357–361, 2001.

## Research Article

# The Impacts of Along-Channel Acupuncture on the Protein Expressions of the Chloride Channel of the Rats with Myocardial Ischemia

Ze-Dong Cheng,<sup>1</sup> Chun-Ri Li,<sup>1</sup> Xiao-Jiao Shao,<sup>1</sup> Pei-Jing Rong,<sup>2</sup> Xiao-Qing Zhang,<sup>1</sup> Fan-Rong Liang,<sup>3</sup> Yuan Li,<sup>1</sup> and Yi-Guo Chen<sup>1</sup>

<sup>1</sup> Liaoning University of Traditional Chinese Medicine, Shenyang 110032, China

<sup>2</sup> Institute of Acupuncture, China Academy of Chinese Medicine, Beijing 100700, China

<sup>3</sup> Chengdu University of Traditional Chinese Medicine, Chengdu 610075, China

Correspondence should be addressed to Yi-Guo Chen; cyg05@hotmail.com

Received 13 April 2013; Accepted 7 June 2013

Academic Editor: Wei-bo Zhang

Copyright © 2013 Ze-Dong Cheng et al. This is an open access article distributed under the Creative Commons Attribution License, which permits unrestricted use, distribution, and reproduction in any medium, provided the original work is properly cited.

Recent evidence suggests that chloride ( $Cl^-$ ) channels are involved in myocardial ischemia. In this study, the impact of acupuncture on the protein expressions of Cystic Fibrosis Transmembrane Conductance Regulator (CFTR) and CLC-2  $Cl^-$  channel of the rats with myocardial ischemia were tested and its mechanism was explored. The rats for experiment were distributed randomly into 5 groups: blank control group, modeling control group, Neiguan (PC-6) treatment group, Lieque (LU-7) control group, and Non-acupoint control group. The rats of all groups, except the blank control group, had myocardial ischemia via multiple subcutaneous injection of isoproterenol (ISO). Electroacupuncture treatment was given to Neiguan (PC-6) treatment group, Lieque (LU-7) control group, and Non-acupoints control group, respectively, once a day for 7 days. The results show that acupuncture can alleviate the myocardial ischemia of cardiac tissue, decrease significantly the activities of serum SOD and MDA, and thereby influence the protein expressions of CFTR and CLC-2 in  $Cl^-$  channels. The results of the study implies that acupuncture suppresses the pathological changes of cardiac tissue of rats with myocardial ischemia and regulates the protein expression of CFTR and CLC-2  $Cl^-$  channels, which may serve as one possible mechanism to reduce myocardial ischemia.

## 1. Introduction

Long-term myocardial ischemia is a key cause for ischemic heart diseases, and a number of studies were conducted on myocardial ischemia. There are many ion channels involved in the pathogenesis of ischemic heart diseases [1]. However, the relationship between cardiovascular disease and function of chloride channel has not been identified. Some of the recent studies explored the protective effect of acupuncture on myocardial ischemia [2]. In some studies [3], CFTR  $Cl^-$  channels are taken as novel therapeutic targets for the treatment of ischemic cardiac diseases. Clinically Acupuncture has been applied widely to treat ischemic heart diseases for a long time, and Neiguan (PC-6) acupoint, as the classic acupuncture point, chosen to apply acupuncture in these treatments. Experimental research shows that acupuncture has

cardioprotective effect on rat's acute myocardial ischemia, and acupuncture on Neiguan (PC-6) may benefit the treatment of myocardial ischemia [4]. However, the underlying mechanism remains unknown. This study is to provide the experimental evidence of the cardioprotective effect of acupuncture in treating myocardial ischemia. As shown in research, acupuncturing Neiguan (PC-6) acupuncture point can change the activities of serum SOD and MDA and the indicators of myocardial ischemia. This study explores the effect of acupuncturing Neiguan (PC-6) on myocardial ischemia treatment and its working mechanism, based on the existing theories and research findings on the effect of acupuncture on myocardial ischemia and employing immunoblotting technique to observe the protein expressions of CFTR and CLC-2  $Cl^-$  channels.

## 2. Materials and Methods

**2.1. Animals.** Male adult Sprague-Dawley rats, weighing  $240 \pm 10$  g, were used in the experiment. Upon arrival, animals were given one week to adjust to the new environment ( $20 \pm 1^\circ\text{C}$ , 45–60% relative humidity, white noise db, and 12/12 h light/dark cycle with the light from 6:00 AM to 6:00 PM), with food and water available freely prior to experimental procedures. All experimental procedures were performed during the light cycle. The animal care procedures were carried out in accordance with the National Institutes of Health Guide for the Care and Use of Laboratory Animals. Every effort was made to minimize their suffering.

### 2.2. Experimental Procedure

**2.2.1. Models Preparation.** All rats were randomly divided into the following five groups ( $n = 10$  per group): (1) blank control group (normal control with no modeling intervention or treatment); (2) modeling control group (only received injection of ISO for modeling); (3) Neiguan (PC-6) treatment group (received injection of ISO for modeling and electroacupuncture at the Neiguan (PC-6) acupoint); (4) Lieque control group (received injection of ISO for modeling and electroacupuncture at the Lieque (UL-7) acupoint); and (5) nonacupoints control group (received injection of ISO for modeling and electroacupuncture at the middle of TianShu and ShenQue points). Except for those in the blank control group, rats were fixed at the supine position and anaesthetized with an intraperitoneal injection of pentobarbital sodium (35 mg/kg). Then, they were connected to the BL-420S biological and functional experimental system to record the normal ECG of rats. After a multipoint subcutaneous injection (on limb roots and back, 5–6 points in total, injection completed within 10 seconds) of ISO (85 mg/kg, two shots in total, 24 hours apart each shot), the model of rat myocardial ischemia was occupied and the II Lead Electrocardiograph (ECG) was recorded, respectively, at the first, the fifth, the tenth, and the fifteenth minute after injection. Following that, the changes of Point J (the cross of QRS wave group and wave T) in each group were observed, and the standard of a successful myocardial ischemia modeling was set when there is a visible decrease [5], as shown in Table 1.

**2.2.2. Electroacupuncture Treatment.** After the successful modeling was established, acupuncture was applied at Neiguan (PC-6) treatment group, Lieque (UL-7) control group, and nonacupoint control group, respectively. For Neiguan (PC-6) treatment group and Lieque (UL-7) control group, the acupuncture points were chosen based on Acupuncture Points Diagram of Experimental Animals established by Association of Experimental Acupuncture Research (AEAR) of the National Association of Acupuncture (NAA). For nonacupoint group, acupuncture was applied at the point in middle of TianShu and ShenQue acupoints.

For Neiguan (PC-6) treatment group and nonacupoint and Lieque (UL-7) control groups, the rats were fixed at supine position and connected to G6805-D electroacupuncture apparatus with  $\phi 0.35 \times 15$  mm acupuncture needles once

TABLE 1: The amplitude values comparison of T wave in rats ECG before and after modeling.

Group	The amplitude value of T wave (mv)	
	Before	After
MG*	$0.16 \pm 0.06$	$-0.08 \pm 0.17$
NG <sup>#</sup>	$0.14 \pm 0.06$	$-0.23 \pm 0.18$
LG*	$0.13 \pm 0.04$	$-0.14 \pm 0.16$
NA*	$0.13 \pm 0.62$	$-0.21 \pm 0.71$

MG: modeling control group, NG: Neiguan (PC-6) treatment group, LG: Lieque (UL-7) control group, NA: nonacupoint control group. All values are means  $\pm$  S.E.M. ( $n = 10$ ). \* $P < 0.05$ , before and after modeling in the same group. <sup>#</sup> $P < 0.01$ , before and after modeling in the same group.

a day. The needle was inserted obliquely to form an angle of approximately 30 degrees against the skin along the meridian which the acupoint belongs to and twisted into the rat skin for 2 mm with density wave at 2–20 Hz and till the limb of rat quivered appropriately and lasts for 20 minutes each time. The modeling control group did not receive any acupuncture, but the rats were fixed in the same way as the groups above did, once a day for the duration of 20 minutes each time.

The rats of each group were anaesthetized with 10% chloral hydrate after 7 days since acupuncture started, the blood samples of the rats in each group were collected and marked with Abdominal Aortic Blood Collection Method, and their heart tissues were taken for backup. Four rats with induced myocardial infarction died during the modeling whereas two rats in the blank control group died of anaesthesia during operation for sampling. The operative mortality was 12%.

**2.3. Staining Rat Myocardial Tissue with HE.** Myocardial tissue was cut into suitable pieces, stained with standard HE staining method, and then observed. The stained tissues were studied by light microscopy.

**2.4. Assay of SOD Activity.** SOD activity was assayed using Total Superoxide Dismutase Assay kit with WST-1 following the manufacturer's instructions. Samples (20  $\mu\text{L}$ ) were used for kinase activity.

**2.5. Assay of MDA Content.** MDA content was assayed using Lipid Peroxidation MDA Assay kit following the manufacturer's instructions. Samples (0.1 mL) were used for kinase activity.

**2.6. Protein Determination.** The protein expressions of Cystic Fibrosis Transmembrane Conductance Regulator (CFTR) and CLC-2  $\text{Cl}^-$  channel with Western Immunoblotting Technology (Western Blot) in each group were assayed. First of all, pyrolysis liquid was put into the rat myocardial tissue based on the ratio of 1 : 10 between pyrolysis liquid and the weight of rat myocardial tissue, and homogenate after its full cracking with 12000 r/min  $4^\circ\text{C}$  centrifugation was obtained with the supernatant as the total protein. After separated by SDS-PAGE electrophoresis, the protein extracted from the sample was transferred onto the membrane by Western Blot. After

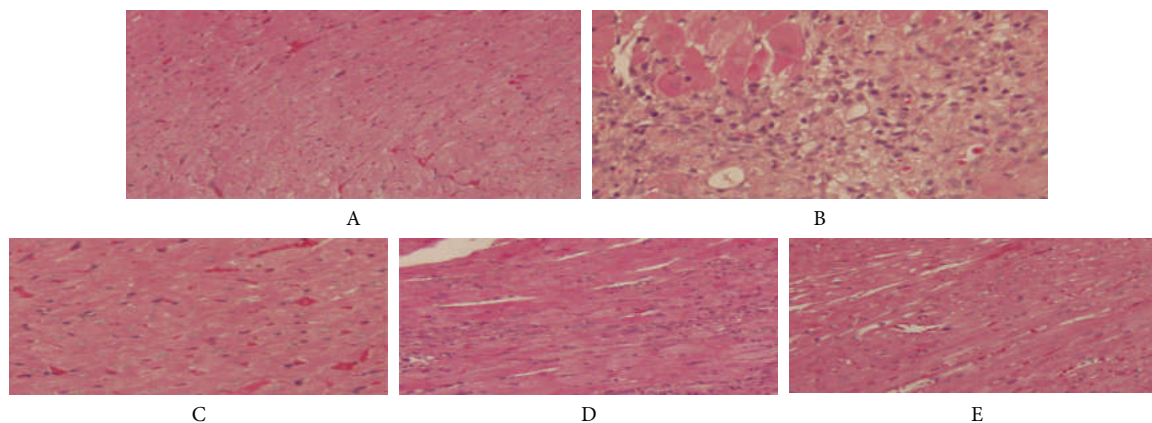

FIGURE 1: Staining results of HE in rats myocardial tissue. (A) control group, (B) modeling group, (C) Neiguan (PC-6) group, (D) Lieque (LU-7) group, (E) nonacupoint group; the same in Figures 2 and 3.

the protein expression of CFTR and CLC-2 in  $CL^-$  channels was assayed with CFTR and CLC-2 antibody, the contents with reference to the known protein were determined.

**2.7. Statistical Analysis.** All results were expressed with means  $\pm$  standard deviation. Group differences were evaluated using one-way analysis of variance (ANOVA). The SPSS 17.0 was used for analysis, and  $P < 0.05$  and  $P < 0.01$  were adopted as the statistical significance levels.

### 3. Results

**3.1. Observation and Comparison of Stained HE Rat Myocardial Tissue Samples among Each Group (Figure 1).** In the blank control group, myocardial fibers are in an ordered arrangement with morphological integrity, full nucleus, and clear boundary, which are visible under twenty-time light microscope. In the modeling control group, the Lieque (LU-7) control group, and the nonacupoint control group, cardiac tissue was observed with the assistance of HE staining. Results showed that myocardial fibers were in disordered arrangement and fracture, sarcoplasm swelling, and obvious inflammation cell infiltration even though there were many brown granules widely distributed in the nucleus. Compared with modeling control group, the changes of cardiac tissue were clearly reduced in Neiguan (PC-6) treatment group under the same physical microscope.

**3.2. The Impact of Acupuncturing Different Acupoints on the Serum SOD Activity in Rat (See Table 2).** Compared with the blank control group, the serum SOD levels of the modeling control group, the Lieque (LU-7) control group, and the nonacupoint control group were significantly lower ( $P < 0.01$ ). Further comparison with the modeling control group showed that the levels of serum SOD were also significantly increased in the Neiguan (PC-6) treatment group ( $P < 0.01$ ). No differences were found between the modeling control group, the Lieque (LU-7) control group, and the nonacupoint control group ( $P > 0.05$ ).

TABLE 2: The results of the level of rats serum SOD ( $\bar{x} \pm s$ ).

Group	<i>n</i>	SOD (U/mL)
CG	8	66.08 $\pm$ 6.90
MG	11	47.30 $\pm$ 11.78*
NG	14	61.78 $\pm$ 7.56 <sup>#</sup>
LG	10	48.20 $\pm$ 12.00*
NA	11	48.74 $\pm$ 11.52*

CG: blank control group, MG: modeling control group, NG: Neiguan (PC-6) treatment group, LG: Lieque (LU-7) control group, NA: nonacupoint control group. \* $P < 0.01$  versus CG, <sup>#</sup> $P < 0.01$  versus MG.

TABLE 3: The results of the contents of rats serum MDA ( $\bar{x} \pm s$ ).

Group	<i>n</i>	MDA (nmol/mL)
CG	8	0.15 $\pm$ 0.01
MG	11	0.19 $\pm$ 0.01*
NG	14	0.13 $\pm$ 0.02 <sup>#</sup>
LG	10	0.19 $\pm$ 0.01*
NA	11	0.17 $\pm$ 0.04*

CG: blank control group, MG: modeling control group, NG: Neiguan (PC-6) treatment group, LG: Lieque (LU-7) control group, NA: nonacupoint control group. \* $P < 0.05$  versus CG, <sup>#</sup> $P < 0.05$  versus MG.

**3.3. The Impact of Acupuncture at Different Acupoints on the Contents of Serum MDA in Rats (Table 3).** Compared with the blank control group, the serum MDA contents of the modeling control group, the Lieque (LU-7) control group, and the nonacupoint control group were significantly higher ( $P < 0.05$ ). Further comparisons with the modeling control group showed that the contents of serum MDA were also significantly elevated in the Neiguan (PC-6) treatment group ( $P < 0.05$ ). No differences were found between the modeling control group, the Lieque (LU-7) control group, and the nonacupoint control group ( $P > 0.05$ ).

**3.4. The Impact of Acupuncturing Different Acupoints on the Protein Expression of CFTR and CLC-2  $CL^-$  Channel in the Rat Myocardial Muscle (See Figures 2 and 3).** Compared with blank control group, there was a significant increase in the

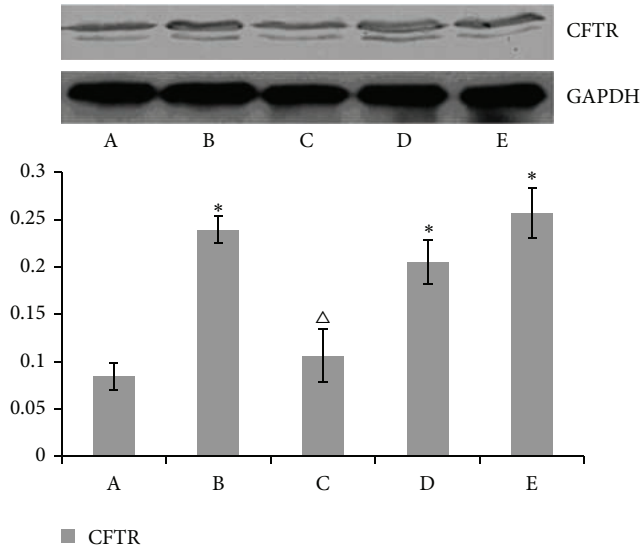

FIGURE 2: The result of CFTR expression in each rat group. The CFTR protein levels were detected by Western Blot. The CFTR expression levels are expressed as a ratio to control levels. The results are representative of three separate determinations. Compared with the blank group, \* $P < 0.01$  with the modeling group  $\Delta P < 0.01$ .

contents of CFTR, CLC-2  $CL^-$  channel protein in the modeling control group, the Lieque (LU-7) control group, and the nonacupoint control group ( $P < 0.01$ ). Further comparison with the modeling control group showed that the contents of CFTR, CLC-2  $CL^-$  channel protein was also significantly elevated in the Neiguan (PC-6) treatment group ( $P < 0.01$ ). No differences were found between the modeling control group, the Lieque (LU-7) control group, and the nonacupoint control group ( $P > 0.05$ ).

#### 4. Discussion

According to classic theories of Traditional Chinese Medicine (TCM), acupuncturing Neiguan (PC-6) acupoint may be applied for treating acute myocardial ischemia, based on its connection with the chest discomfort and cardiodynia. As illustrated in *Experience on Acupuncture and Moxibustion Therapy*, acupuncture at Neiguan (PC-6) can be adopted to treat the sudden pain in the heart, fear, upset, and dementia. In *Compendium of Acupuncture and Moxibustion*, it is also maintained that acupuncture at Neiguan (PC-6), Daling (PC-7), or Quze (PC-3) may serve the purpose of treating pain in the chest and heart. It is also used to treat many kinds of heart diseases in clinical treatment. A number of clinical studies indicate a better curative effect on the treatment of acute myocardial ischemia that can be reached by acupuncturing at Neiguan (PC-6), as it has a tranquilizing effect and can relieve clinical symptoms of breast-pang patients and improve ischemic ECG [6]. It is confirmed in animal experiments that electroacupuncture at Neiguan (PC-6) acupoint can improve the function of left ventricular, myocardial microcirculation, and oxygen supply, besides reducing and narrowing the degree of myocardial ischemia. For acute ischemic heart disease, electroacupuncture at Neiguan (PC-6) acupoint can

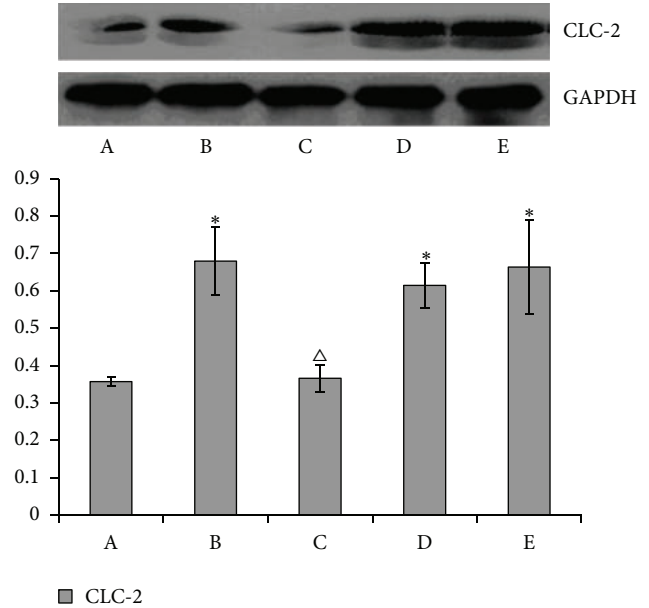

FIGURE 3: The result of CLC-2 expression in each rat group. The CLC-2 protein levels were detected by Western Blot. The CLC-2 expression levels are expressed as a ratio to control levels. The results are representative of three separate determinations. Compared with the blank group, \* $P < 0.01$  with the modeling group  $\Delta P < 0.01$ .

improve hemodynamic disturbance, increase myocardial tension, adjust the contractility, and correct arrhythmia [7].

Modeling rats with acute myocardial injury caused by isoproterenol (ISO) were used in this study since the model is one of those classical method to study the effect of anti-myocardial ischemia [8]. Injecting a large dose of ISO continuously may lead to a myocardial ischemic injury as ISO is a  $\beta$  receptor excitomatory. The present study confirms the changes of ECG, myocardial metabolism, and histopathology of the rats injured by a large dose injection of ISO, similar to a natural occurrence of myocardial ischemic injury [9].

Superoxide dismutase (SOD) is an important antioxidant enzyme in cardiac muscle, which removes the surplus oxygen free radicals (OFR), protects other antioxidant enzymes from ORF inactivation, and reduces the damage. The activity of SOD indirectly reflects the ability of the body to remove OFR with a negative correlation [10]. The experiment result shows that the content of rats serum SOD is clearly increased in the Neiguan (PC-6) treatment group ( $P < 0.01$ ), but there was no significant difference in the Lieque (LU-7) control group and nonacupoint control group compared with the modeling control group ( $P > 0.05$ ). This indicates that acupuncture at Neiguan (PC-6) can effectively control the degree of rat myocardial damage and significantly increase the serum SOD content and the activity of SOD and thereby reduce the damage of oxygen free radicals to myocardial cells. While no such effects can be achieved by acupuncturing at Lieque acupoint or nonacupoint points.

MDA is the end product of oxygen free radical and lipid peroxidation and reflects the extent of myocardial injury. The results of this study show that the content of serum MDA in rats is clearly decreased in the modeling control group, the



Lieque (LU-7) control group, and the nonacupoint control group ( $P < 0.05$ ), compared with the blank control group. Compared with the modeling control group, the content of serum MDA in rats in the Neiguan (PC-6) treatment group is significantly reduced ( $P < 0.05$ ), but no clear changes were observed in the Lieque (LU-7) and nonacupoint control groups ( $P > 0.05$ ).

There are many kinds of ion channels in myocardial cell, which play an important role when there are hypoxia, swelling, or endogenous catecholamines releasing caused by regional myocardial ischemia in heart. It is proved in recent studies [11, 12] that the chloride channels are involved in the protection against myocardial ischemia and reperfusion. The first cardiac CFTR  $CL^-$  channel of cDNA gene encoding cloned Riordan discovered in the year 1989 is one of phosphorylation dependent epithelial cells chloride channel [13]. The loss or dysfunction of CFTR channel may cause a variety of diseases, as shown in research [14]. CLC-2 inwardly rectifies chloride current obtained from the atrial and ventricular muscle records of mice and guinea pigs, as proved by Duan et al. in 1999 [15]. It plays an important role in the electrical activities of heart the same as cationic inward rectifier channels. The study shows that the protein expression of CFTR and CLC-2  $CL^-$  channel in the modeling control group and Lieque (LU-7) and nonacupoints control groups is clearly higher than that in Neiguan (PC-6) treatment group and blank control group ( $P < 0.05$ ), but there is no difference between the modeling, Lieque, (LU-7) and nonacupoints control groups ( $P > 0.05$ ). The results of the current study show that the myocardial ischemia of rats may be caused by an increased concentration of protein CFTR and CLC-2 after activating chloride channel of myocardial tissue. Blocking of  $CL^-$  channel by acupuncture at Neiguan (PC-6) can reduce the concentration of protein CFTR and CLC-2, which could be one mechanism to treat rat myocardial ischemia.

Acupuncture points are the specific sites where the qi of zang-fu organs and channels is transported to the surface of body. Acupuncture points are not only the reflecting places of disorders but also the sites to receive the stimulation by acupuncture and moxibustion for treatment. In history, Chinese medical scientists have observed and theorized the significant role that channels play in connecting the acupoints on body surface and the internal organs, which has been widely applied in clinical practice for nearly two thousand years.

Neiguan (PC-6) acupuncture point is a Luo-connecting point of Pericardium Meridian of Hand Jueyin. It is not only one of the eight confluence points but also a key point in Yinwei Meridian, which stops the pain and soothes heart and chest; thus acupuncture at Neiguan (PC-6) can treat the pain of heart and chest caused by blood stasis. And Pericardium Meridian, known as the protector of heart, can regulate the function of heart. As shown in the results of this study, acupuncture at nonacupoint or Lieque (LU-7) cannot treat rat myocardial ischemia as effectively as acupuncture at Neiguan (PC-6) can do. As one of the Hand Jueyin Pericardium Meridian points, acupuncturing Neiguan (PC-6) has a visible effect in treating ischemia via regulating the protein expression of chloride channel in myocardial tissue.

In summary, acupuncture at Neiguan (PC6) on rats with myocardial ischemia reflects the treatment efficacy of acupuncturing along channels. One of its treatment mechanisms can be interpreted by its adjustment of the protein expression of chloride channels CFTR and CLC-2 in myocardial cells, as proved in this study.

## Acknowledgment

This work was supported by the National Program on Key Basic Research Project (973 Program, Grant no. 2012CB518503).

## References

- [1] C. Richard and C. R. Conti, "Ion channel therapy of ischemic disease," *Chinese Journal of Cardiovascular Disease*, vol. 40, no. 3, pp. 254–255, 2012.
- [2] S.-B. Wang, S.-P. Chen, Y.-H. Gao, M.-F. Luo, and J.-L. Liu, "Effects of electroacupuncture on cardiac and gastric activities in acute myocardial ischemia rats," *World Journal of Gastroenterology*, vol. 14, no. 42, pp. 6496–6502, 2008.
- [3] S. Y. Xiang, L. L. Ye, L.-L. M. Duan et al., "Characterization of a critical role for CFTR chloride channels in cardioprotection against ischemia/reperfusion injury," *Acta Pharmacologica Sinica*, vol. 32, no. 6, pp. 824–833, 2011.
- [4] L.-H. Diao, Z.-B. Yang, G.-X. Zhou et al., "Observation on therapeutic effects of electroacupuncture at Neiguan (PC 6) on silent myocardial ischemia," *Chinese Acupuncture & Moxibustion*, vol. 31, no. 7, pp. 591–594, 2011.
- [5] D. C. Wang, Q. Y. Li, and X. X. Zhu, "An experimental study of guanxinping on isoprenaline-induced myocardial ischemia," *Chinese Journal of Experimental Traditional Medical Formulae*, vol. 16, no. 10, pp. 143–146, 2010.
- [6] M. L. Li, H. Wang, and Z. B. Chen, "Effect of electrocardiogram (ECG) and ultrastructure in acute myocardial ischemia rats by elec-acupuncture on NeiGuan acupoint," *Chinese Journal of Integrative Medicine on Cardio-/Cerebrovascular Disease*, vol. 5, no. 8, pp. 708–710, 2007.
- [7] C. H. Song, "The progress of the acupuncture mechanism study in breast-pang and coronary disease," *Journal of Clinical Acupuncture*, vol. 24, no. 4, pp. 49–51, 2008.
- [8] B. Z. Simkhovich, K. Przyklenk, and R. A. Kloner, "Role of protein kinase C as a cellular mediator of ischemic preconditioning: a critical review," *Cardiovascular Research*, vol. 40, no. 1, pp. 9–22, 1998.
- [9] P. Claus, F. Weidemann, C. Dommke et al., "Mechanisms of postsystolic thickening in ischemic myocardium: mathematical modeling and comparison with experimental ischemic substrates," *Ultrasound in Medicine and Biology*, vol. 33, no. 12, pp. 1963–1970, 2007.
- [10] W. K. Wu, H. Yang, and M. Q. Zhao, "Mechanisms of heart failure induced by adriamycin," *Chinese Journal of Pathophysiology*, vol. 20, no. 8, pp. 1437–1439, 2004.
- [11] R. J. Diaz, V. A. Losito, G. D. Mao, M. K. Ford, P. H. Backx, and G. J. Wilson, "Chloride channel inhibition blocks the protection of ischemic preconditioning and hypo-osmotic stress in rabbit ventricular myocardium," *Circulation Research*, vol. 84, no. 7, pp. 763–775, 1999.

- [12] D.-Y. Duan, L. L. H. Liu, N. Bozeat et al., "Functional role of anion channels in cardiac diseases," *Acta Pharmacologica Sinica*, vol. 26, no. 3, pp. 265–278, 2005.
- [13] S. S. Zhou and Y. M. Zang, "The character and significance of current in ventricular muscle  $\text{Cl}^-$  channels," *Progress in Physiological Sciences*, vol. 27, no. 3, p. 359, 1996.
- [14] T. Ntimbane, B. Comte, and G. Mailhot, "Cystic fibrosis-related diabetes: from CFTR dysfunction to oxidative stress," *The Clinical Biochemist Reviews*, vol. 30, no. 4, pp. 153–177, 1999.
- [15] D. Duan, L. Ye, F. Britton et al., "Purinoreceptor-coupled  $\text{Cl}^-$  channels in mouse heart: a novel, alternative pathway for CFTR regulation," *Journal of Physiology*, vol. 521, no. 1, pp. 43–56, 1999.

## Research Article

# Evaluating Meridian-Sinew Release Therapy for the Treatment of Knee Osteoarthritis

Song Wei,<sup>1</sup> Zhi-Huang Chen,<sup>1</sup> Wei-Feng Sun,<sup>1</sup> Geng-Peng Zhang,<sup>1</sup> Xiao-Hao Li,<sup>1</sup> Chun-Fu Hou,<sup>2</sup> Liu-Dan Lu,<sup>2</sup> and Lu Zhang<sup>2</sup>

<sup>1</sup> Department of Traditional Chinese Medicine, Guangzhou General Hospital Of Guangzhou Military Command, Guangzhou 510010, China

<sup>2</sup> Guangzhou University of Traditional Chinese Medicine, Guangzhou 510405, China

Correspondence should be addressed to Song Wei; 18665032086@163.com

Received 22 March 2013; Revised 7 June 2013; Accepted 7 June 2013

Academic Editor: Wei-bo Zhang

Copyright © 2013 Song Wei et al. This is an open access article distributed under the Creative Commons Attribution License, which permits unrestricted use, distribution, and reproduction in any medium, provided the original work is properly cited.

**Objective.** In recent years, public health experts have concluded that the impact of osteoarthritis is equal in magnitude to that of cardiovascular disease. Osteoarthritis of the knee is prevalent in the elderly population; however, there are currently no effective treatments for this condition. In this study, we investigated the efficacy of “meridian-sinew release,” a newly developed technique which entails using a meridian-sinew scope and a meridian-sinew knife to treat osteoarthritis of the knee. **Methods.** Patients ( $N = 90$ ) with knee osteoarthritis were prospectively randomized to meridian-sinew release therapy, acupuncture therapy, or drug therapy groups, respectively. Outcome evaluation included pain, stiffness, physiological function, total symptom score, and overall changes in the condition. **Results.** After 12 weeks, patients’ general assessment (GA) and doctors’ general assessment (GA) of the condition were not significantly different among the three groups. However, significant differences in primary endpoint pain, joint stiffness, and total symptom score were found between the meridian-sinew group and the acupuncture group and between the meridian-sinew group and the control group ( $P < 0.05$ ). No adverse events occurred during the trial. **Conclusion.** Our study suggests that meridian-sinew release therapy can improve knee osteoarthritis, alleviate joint pain, and improve functional movement disorder. It is a safe and effective treatment for knee osteoarthritis.

## 1. Introduction

Osteoarthritis is a degenerative joint disease that occurs mainly in the elderly. It is characterized by the peripheral (i.e. a, osteophytes) erosion of articular cartilage, bone hypertrophy, and subchondral sclerosis. Osteoarthritis is the most common form of arthritis in the elderly and also one of the main causes of disability in that population [1, 2]. Due to the fact that the knee joint is a peripheral axial, weight-bearing joint, it is most commonly affected by osteoarthritis [3]. Studies have shown that the incidence of knee osteoarthritis in people over age 65 is 60%–70%, with the incidence rate reaching up to 85% in the population over age 75 [4]. In the United States, approximately 21 million Americans suffer from the disease [5], and it is estimated that the total cost of treating arthritis may be close to 2.5% of its gross domestic product (GDP). Therefore,

the impact of osteoarthritis on public health has recently been compared to the impact of cardiovascular disease [6]. The main clinical symptoms of knee osteoarthritis are pain and joint stiffness [7]. However, no effective treatment for knee osteoarthritis has been developed to date. Usual care, based on the guidelines published by the American College of Rheumatology (ACR) and the European Association of Rheumatology Union, focuses on alleviating the symptoms of pain and stiffness and maintaining or improving physical function [8, 9]. Our goal in this study was to find a more effective treatment that would reduce joint pain and disability and prevent and mitigate cartilage degradation [10]. Conventional treatment for knee osteoarthritis is designed to control symptoms and pain and includes nonsteroidal anti-inflammatory drugs, glucosamine, topical analgesics, intra-articular injection of sodium hyaluronate and surgical treatment [11, 12]. However, none of these treatments are

considered curative and are often accompanied by side effects ranging from patient discomfort to liver and kidney damage. Most knee osteoarthritis patients are not satisfied with the recurring side effects of conventional drug therapy [13, 14]. As a result, many knee osteoarthritis patients use complementary and alternative therapies. In China, Traditional Chinese medicine (including acupuncture) has been used for thousands of years and has been shown to be particularly efficacious for treating pain, especially when related to joint diseases such as osteoarthritis [15–18]. Due to the limitations and side effects of conventional therapies, more and more people are turning to complementary and alternative medicine. Therefore, it is necessary to explore and scientifically evaluate the efficacy of new therapies for this disorder.

In meridian-sinew release therapy, a physician uses a “meridian-sinew scope” to observe local tissue while simultaneously using a “meridian-sinew knife” to loosen and release adhesions. Indications include joint and myofascial pain, as well as the local, refractory pain and inflammation in rheumatoid disorders. This may be a new, effective treatment for these disorders that can replace conventional therapy. In China, this therapy has been used to treat a variety of rheumatoid disorders involving joint swelling and pain, including knee osteoarthritis and rheumatoid arthritis [19–22]. In our hospital, we have found that this therapy can relieve the pain and stiffness associated with knee osteoarthritis, with results that can be maintained for a relatively long period of time. We also believe it can slow down the degeneration of articular cartilage and maintain and improve joint function [21, 22]. The technique causes minimal injury to local tissue without compromising the overall structure of the knee. There are minimal bleeding and rapid patient recovery. Our results are consistent with research that has shown that soft tissue release can effectively alleviate myofascial pain in the forearm caused by external humeral epicondylitis [23].

We performed a randomized, controlled study in order to further evaluate the efficacy and safety of meridian-sinew release therapy for treating knee osteoarthritis. The basic design of this study was to quantify and compare the efficacy of meridian-sinew release therapy, acupuncture, and routine drug treatment for knee osteoarthritis. We hoped that our data would help guide policy makers in determining whether this therapy should be more widely available as a new, safe, and effective treatment for osteoarthritis of the knee.

## 2. Materials and Methods

**2.1. Subjects.** Patients hospitalized in Guangzhou General Hospital Of Guangzhou Military Command from January 2008 to December 2011 were recruited. The diagnosis of knee osteoarthritis was made according to the Kellgren grading standard, and patients with grade II or III were included; this was also consistent with the American College of Rheumatology standards [24–26]. We applied the following criteria for inclusion in the study: (i) age 45 years or older; (ii) diagnosis of osteoarthritis of the knee of at least 6 months duration;

(iii) moderate to severe pain during most days throughout the past months and use of analgesics for at least 1 month; (iv) willing and able to complete the study protocol. The exclusion criteria were intra-articular corticosteroid injection into the knees within 4 weeks preceding the study and severe, unstable chronic illness (including but not limited to congestive heart failure, chronic renal failure, tumors in the knee, autoimmune diseases such as rheumatoid arthritis, ankylosing spondylitis, congenital deformity of the knee, and trauma-induced osteoarthritis of the knee). During the study period, patients were treated with conventional drug therapy (glucosamine sulfate capsules: take 2 capsules 3 times daily, manufacturer: Rottapharm Srl, Italy, approval number: X19990394; celecoxib: take 1 capsule daily, manufacturer: Pfizer Pharmaceuticals LLC, USA, approval number: J20080059) but were not allowed to begin new drug treatment or change the dosage of current medication. The study was approved by the Ethics Committee of Guangzhou General Hospital Of Guangzhou Military Command Area, and all patients signed informed consent forms.

Estimation of sample size was based on the results of previous studies and then calculated according to the calculation formula for sample size estimation, with a clinical efficacy increase of 25% from the original level. The calculation formula was as follows:  $n = (U_{\alpha} + U_{\beta})^2 2P(1 - P)/(P_1 - P_0)^2$  [27].

**2.2. Interventions and Randomization.** Patients were told that the study had been designed to evaluate and compare the efficacy of meridian-sinew release therapy, acupuncture and conventional drug therapy for knee osteoarthritis and that they would be required to give up other forms of treatment for the duration of the study. Patients were randomly assigned to the meridian-sinew release therapy group, acupuncture group or control group through computer-generated random numbers. Patients in the meridian-sinew release therapy group were treated with conventional drug therapy plus meridian-sinew Release therapy, patients in the acupuncture group were treated with conventional drug therapy plus acupuncture, and patients in the control group were treated with conventional drug therapy without any other additional treatment.

### 2.3. Treatments in Detail

**2.3.1. Meridian-Sinew Release Group.** A minimally invasive technique has been invented (Figures 1 and 2) to release connective tissue adhesions and alleviate joint and myofascial pain [19–22]. The meridian-sinew scope and meridian-sinew knife technology are based on the concept and description of the “Nine Needles” found in the Han dynasty classic of traditional Chinese medicine, *The Yellow Emperor’s Inner Canon*. This modality is an improvement on the ancient method and is now used in modern-day China to treat rheumatoid pain. The course of treatment for meridian-sinew release therapy treatment was 4 weeks. In the 1st week, the meridian-sinew scope was used to release adhesions. The procedure was as follows: local anesthesia was given according to

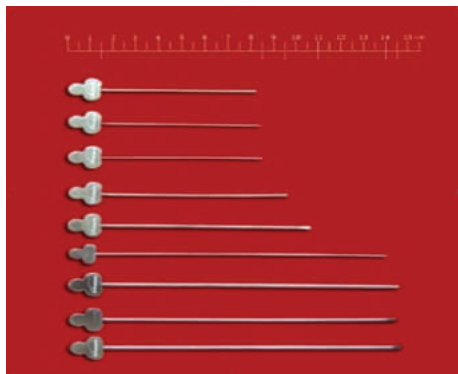

FIGURE 1: Meridian-sinew knives.



FIGURE 2: Meridian-sinew scope and surgical instruments.

the conventional standard, and a small incision was made with a scalpel in order to insert the meridian-sinew scope into the anterolateral aspect of the knee joint. The meridian-sinew scope was inserted into the incision, and anatomical changes in the structure of intra-articular tissue were observed, and the scope was slowly moved toward the lesions. In addition to the forward movement, side movement was also performed to order to inspect the suprapatellar bursa, patellar joint space, medial tibial space, medial meniscus, medial crypts, fossa intercondyloidea, lateral tibial clearance, meniscus lateralis, and cornucopia in the joint cavity. The needle knife was inserted to release adhesive tissue in the articular antrum. At the same time, the joint cavity was flushed with water and drained through a standard drainage tube until the fluid became clear.

In the 2nd, 3rd, and 4th weeks, patients were treated with the meridian-sinew knife only. Treatment sites were chosen based on the textbook, *China Meridian Sinews* [28], and consisted of major sites (similar to acupuncture or acupressure points) along the pathways of meridian sinews in the vicinity of the knee. The main sites included *binxia* (the lower edge of the patella, patella articular surface), *binwai* (the outer edge of the midpoint of patella), *binneixia* (the lower margin of patella, the initial part of the medial patellar retinaculum vice), *chengshanci* (triceps surae fascia and tendon junction), *chengshanwai* (lateral gastrocnemius muscle belly and hamstring nodes), *weiyangci* (the lateral end of popliteal transverse line, unit two quadriceps medial

margin), *ciliaoci* (the inner side of the femoral condyle), the head of fibula (the upper edge of fibula), the medial tibial condyle (tibia epicondyle anterior medial eminence), and *xiguanci* (the medial part of the medial condyle of the tibia, medial margin). We marked points with gentian violet, injected local anesthesia (lidocaine 0.2%, 1 mL), and inserted the meridian-sinew knife until it reached the surface of the bone. We released the adhesions with horizontal movements and opened the meridian-sinew pathways with vertical movements. This was performed 3 times a week for 3 weeks.

**2.3.2. Acupuncture Group.** In the acupuncture group, at least 6 acupoints were chosen for treatment from the following: ST34, ST35, ST36, SP9, SP10, BL40, KII0, GB33, GB34, and LR8. In addition, at least 2 distal points were chosen from the following: SP4, SP5, SP6, ST6, BL20, BL57, BL58, BL60, BL62, and KI3 [29]. Acupuncture was performed using needles 40 mm in length with a diameter of 0.25 mm (Huatuotuo, Suzhou Medical Instruments Factory, Suzhou, China). Needles were inserted perpendicularly with the aid of a guide tube and moved to a depth of 10 mm using slight rotation and thrusting. Deqi sensation was obtained and reported by the participants as a dull ache, numbness, or heaviness. Needle manipulation was repeated approximately every 5 min to maintain the Deqi sensation, and each treatment session lasted for 30 min. Treatment was given 3 times a week for 4 weeks.

**2.3.3. Control Group.** Patients were given conventional drug therapy.

**2.4. Outcome Evaluations.** The knee with the worst arthritis pain (target joint) at screening was the joint used for evaluation of efficacy. The main outcome indicator was the visual analogue scale (VAS) for pain (the Western Ontario and McMaster University Osteoarthritis Index visual analogue scale (WOMAC) version 3.1), western Ontario province and the University of McMasters Osteoarthritis Index pain (VAS WOMAC version 3.1), including pain (five questions), stiffness (two questions), physical function (17 questions), and total symptoms (24 questions) [30, 31]. WOMAC evaluation, with scores from 0 to 100 mm (0 represents no pain and 100 represents the most severe pain), was implemented before the treatment and after 12 weeks of treatment.

The patient general assessment, physician general assessment, and the MOS item short form health survey (SF-36) (version 2), which are secondary endpoints, were used to assess the overall health-related quality of life and were collected before the start of treatment and after 12 weeks of treatment. The patient general assessment and physician general assessment were scored on a five-point Likert scale for overall arthritis disease status (0 = very well, 1 = well, 2 = moderate, 3 = poor, and 4 = very poor) and response to therapy (0 = excellent response, 1 = good response, 2 = moderate response, 3 = slight response, and 4 = no response). SF-36 was chosen due to its previous application in a variety of diseases including osteoarthritis efficacy studies [32–34].

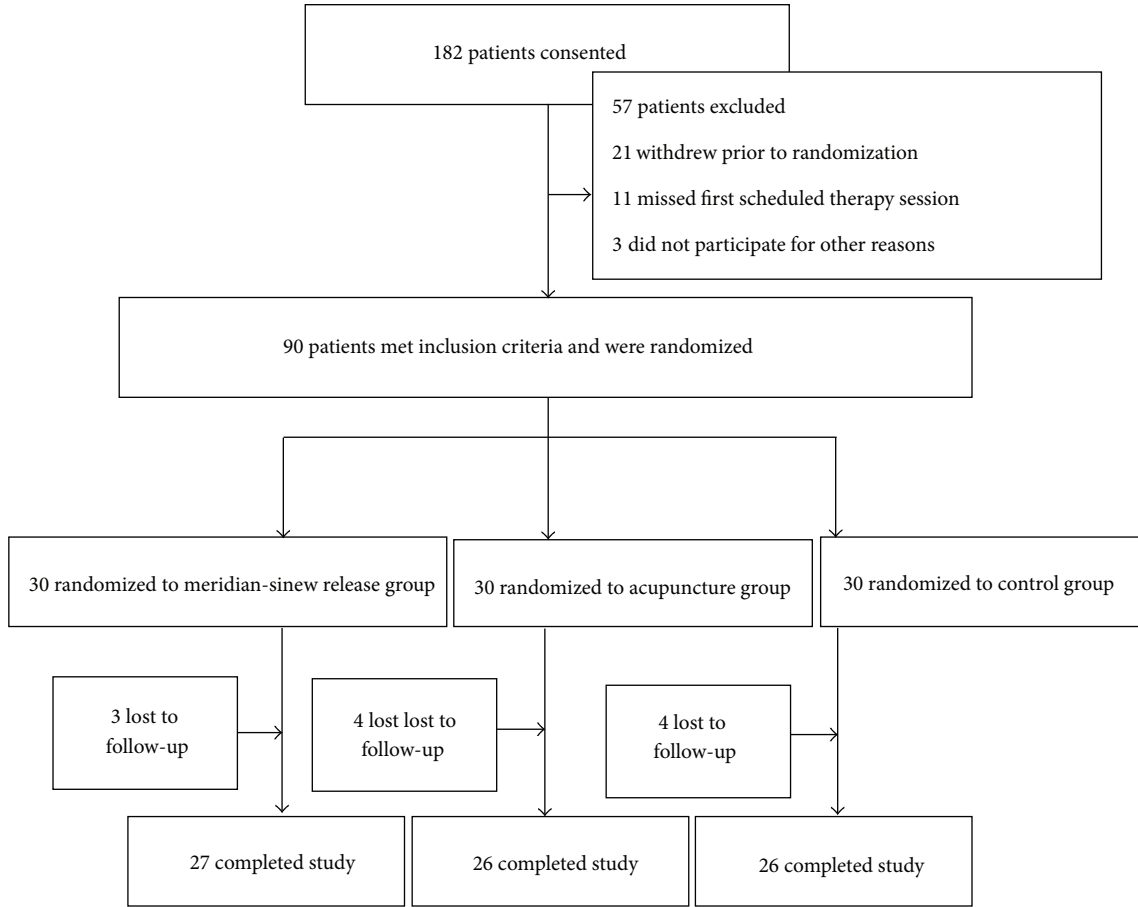

FIGURE 3: Flow chart of the distribution of the study cohort.

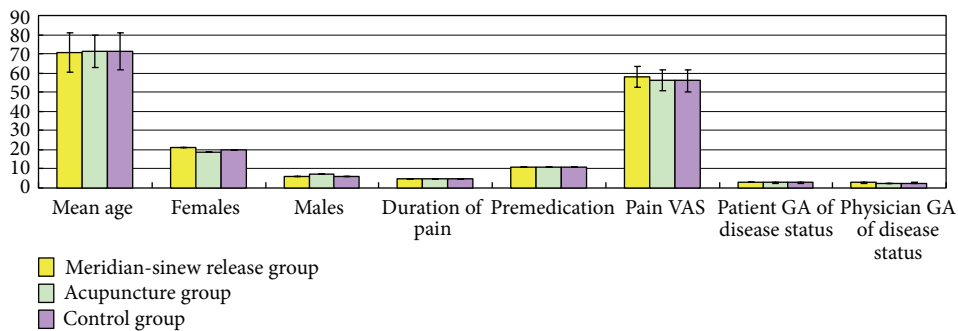

FIGURE 4: Baseline comparison of the randomized groups by treatment types.

**2.5. Statistical Analysis.** An intent to treat-based analysis was performed using the SPSS 16.0 system. The changes from baseline to week 12 between treatment and placebo groups were considered significant for independent samples *t*-test *P* values <0.05, (95% confidence level).

**3. Results**

Between January 2008 and December 2011, we identified 182 patients with a diagnosis of knee osteoarthritis. We excluded 92 patients because they did not meet the inclusion criteria,

were not willing to participate in the study, or did not strictly adhere to the study regimen. We enrolled 90 patients with knee osteoarthritis in the study. Figure 3 shows the patient recruitment, allocation, follow-up losses, and the exclusion. Figure 4 describes the baseline characteristics of the patients. 3 patients in the meridian-sinew theory group dropped out, citing pain levels, surgery, or personal reasons. 4 patients in the acupuncture group dropped out, two due to pain levels and two for personal reasons. 4 patients in the control group dropped out, one due to pain, one due to surgery, and two due to personal reasons.

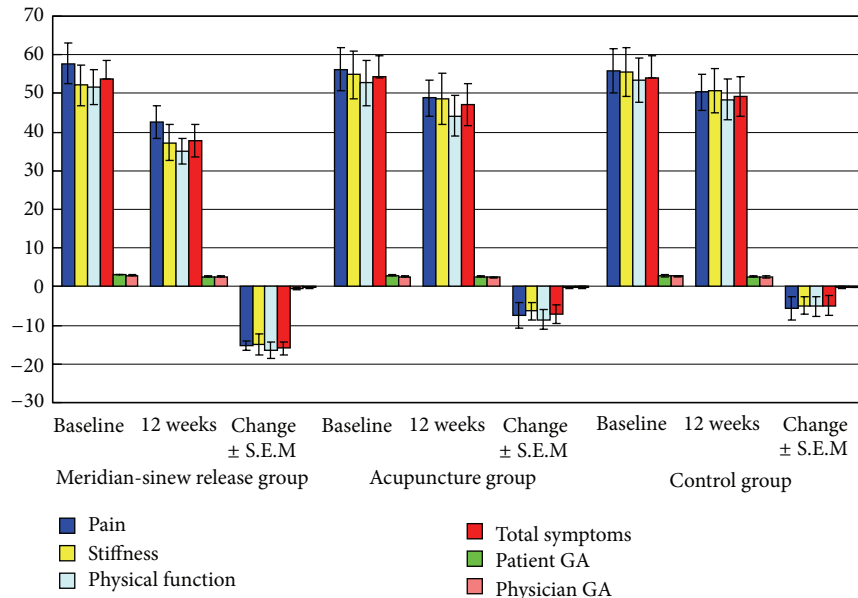

FIGURE 5: WOMAC, patient and physician GAs.

The results of WOMAC are shown in Figure 5. In the meridian-sinew release group, changes in the primary endpoint of pain at week 12 were significantly greater than in the acupuncture group or the control group ( $P = 0.041$  and  $P = 0.028$ , resp.) ( $P < 0.05$ ). Changes in physiological function in the meridian-sinew release group were also significantly better at week 12 than the acupuncture group or the control group ( $P = 0.045$  and  $P = 0.030$ , resp.) ( $P < 0.05$ ). Improvement in joint stiffness was greater in the meridian-sinew release group compared to the acupuncture group after 12 weeks of treatment and the control group ( $P = 0.048$  and  $P = 0.032$ , resp.) ( $P < 0.05$ ). Total symptom score changes in the meridian-sinew release group were also higher than those in the acupuncture group and the control group ( $P = 0.046$  and  $P = 0.031$ , resp.) ( $P < 0.05$ ). Changes in the patients' general assessment and physicians' general assessment were not significant in any of the three groups at week 12 ( $P > 0.05$ , Figure 5). However, the patients' general assessment and physicians' general assessment in the meridian-sinew release group and the acupuncture group had a significant trend towards improvement. There were no significant differences between the patient's general assessment and the physician's general assessment. The results of the SF-36 nine domains of quality of life survey showed that at week 12 the only significant change was in the physical status domain in the meridian-sinew release group, with a mean change of 17.12 (SD = 21.05,  $P = 0.023$ ) ( $P < 0.05$ ). In the acupuncture group, a mean change of 12.69 (SD = 23.81,  $P = 0.175$ ) ( $P > 0.05$ ) was observed in the physical status domain, and in the control group, the physical status domain at 12 weeks showed a mean change of 11.71 (SD = 24.08,  $P = 0.192$ ) ( $P > 0.05$ ). No notable change was found in the other eight domains ( $P > 0.05$ ). There were no adverse events during the trial.

#### 4. Discussion

These results suggest that meridian-sinew release therapy is a safe and effective method for the treatment of knee osteoarthritis. It was shown to be more effective than either routine acupuncture or routine drug therapy for the alleviation of pain and improvement of physiological function. In a recent systematic review, acupuncture was shown to relieve the pain of chronic knee osteoarthritis and improve movement function, both in the short-term (2–15 weeks) and long-term (26–52 weeks) tests [35]. In addition, the results of another clinical trial also indicated that acupuncture can relieve knee pain and improve function scores of knee osteoarthritis [36].

In our study, significant differences in primary endpoint pain, joint stiffness, and total symptom score were found between the meridian-sinew release group and acupuncture group and between the meridian-sinew release group and control group. This suggests that meridian-sinew release therapy can significantly improve knee osteoarthritis pain, joint stiffness, and physical function. The changes of overall disease status of arthritis in patients' general assessment and doctors' general assessment did not change significantly in any of the three groups. We suspect that the treatment time was too short or the sample size was too small to assess overall changes in the disease state; therefore, our next step is to explore this question with a larger and longer study design. In the meridian-sinew release group, the arthritis disease status had obviously improved after treatment. This suggests that the meridian-sinew therapy may be able to improve the overall disease status of knee osteoarthritis given a longer course of treatment. During the study, the meridian-sinew release group patients had no adverse events, indicating that meridian-sinew release therapy is safe.

This study used a randomized, controlled clinical trial design. However, because meridian-sinew release therapy and acupuncture are quite different methods, it was impossible to blind the patients. Instead, we adopted three separate principles: a single-blinded operator, a blinded observer, and statistical separation.

Knee osteoarthritis is an arthropathy characterized by hyperostosis due to degeneration of cartilage in the knee. Pain is the most typical clinical manifestation and the primary treatment target of the disease [37]. In the theory of traditional Chinese medicine, knee osteoarthritis is classified as a meridian-sinew disease. Meridian-sinews, also known as the 12 meridian-sinews, are a body system that is formed when *Qi* from the twelve meridians is distributed in the muscles, tendons, ligaments, and joints. The 12 meridian-sinews are dependent upon the 12 regular meridians. The pathway and distribution of the meridian-sinews are basically the same as those of the twelve meridians, with the significant exception that they all move towards the heart. The distribution of the twelve meridian-sinews has 4 features: “knot” (*jie*), “gather” (*ju*), “scatter” (*san*), and “distribute” (*bu*). Meridian-sinews “knot” or “gather” in the joints, which means that they converge mostly in the wrist, elbow, shoulder, neck, ankle, knee, hip, and other joints. They are said to “scatter” or “distribute” in the chest, back or head, and face. Although some meridian-sinews are broadly distributed throughout the body cavity, they do not directly connect with the viscera. The functions of the meridian-sinew are to constrain bones, control the flexion-extension of joints, and to maintain the body’s ability to have normal, physiological movement. Dr. Xue believes that the meridian-sinews serve as an essential link between various tissues and organs of the human body, and, relative to the regular meridians, they have a more tangible structure and more easily quantified functions [38]. In the view of modern medicine, meridian-sinews are basically equivalent to connective tissue in terms of function. Anatomically, they include muscles, tendons, fascia, ligaments, joint capsules, synovial fluid, and other systems [39, 40]. The structure of the knee is composed of muscles, tendons, ligaments, joint capsule, and synovial; therefore, in traditional medicine it is said that “the knee is the confluence of tendons.” Many meridian-sinews gather and conjoin around the knee; therefore, lesions associated with the knee are related to dysfunctions of the meridian-sinew system. In fact, lesions often correspond exactly to the “knots” or “gatherings” along the course of the meridian-sinews [41].

“Meridian-sinew disease” is defined as acute and chronic disease of the muscles, tendons, and joint synovium [42]. Traditional Chinese medicine theory states that “When Wind, Cold and Dampness invade the space between the surface and the “divisions in the flesh,” (fascia-muscles) the damage leads to the formation of “foam.” When foam meets cold it coagulates, and the resultant gatherings displace and break-up the fascia-muscles, thereby causing pain.” Exogenous, pathogenic *Qi* in the form of wind, cold, and heat, excess emotions that harm the *Qi* and blood, trauma to the sinews, and cumulative fatigue may all cause body fluids to coagulate and form “foam.” The “foam” leads to swelling and pain in body. If the pathologies affecting the meridian-sinew are

not resolved in a timely manner, “foam” will coagulate and change to “phlegm” [43]. Phlegm-fluid retention obstructs the meridians and leads to pathological changes like spasm, cramps, pain and stiffness. Phlegm and blood stasis entangled in the fascia’ muscle may form “strips” and “nodules” along the course of the meridian-sinews course, which will obstruct the channels and eventually lead to both regional and overall (in the entire meridian system) fascia contracture.

In this study, the meridian-sinew scope allowed us to view various kinds of phenomena including blood stasis, foam, and phlegm (Figures 6, 7, 8, 9, and 10). Using color ultrasound, we discovered that the myofascia was significantly thickened (Figure 11). We concluded that “strips” and “nodules” hinder the movement of *Qi* and blood in meridian channels, which leads to irreversible inflammatory exudation and foam accumulation. Zhang et al. discovered a low hydraulic resistance channel along meridians through which interstitial fluid is easy to flow [44]. The channel exists within fascia meridians and can be influenced by the state of the fascia meridians. Whenever strips and nodules are formed, they may hinder the flow of interstitial fluid and cause an accumulation of inflammatory substances in the interstice, inducing pain or hyperalgesia.

Opening the fascia meridians is the key to clearing the pathways of the regular meridians. According to the theory of the meridian-sinews, this therapy can be used to release the adhesions along the fascia meridians in order to get rid of obstructions in the meridians and to decrease inflammatory exudation. This is why meridian-sinew release therapy is effective for treating the pain of arthritis.

In order to “disentangle” different structures of the body that seem to play a role in disease [45], Mr. Wei invented the meridian-sinew scope and meridian-sinew knife, drawing inspiration from the “large needles” and “long needles” described in the Nine Needles and Twelve Sources chapter of the Yellow Emperor’s Inner Classic. Recent clinical reports have shown that treatment with meridian-sinew scope and meridian-sinew knife has obtained satisfactory effects [19–22]. Through the meridian-sinew release treatment, adhesions in the soft tissue around the knee are released, decreasing spasms in the surrounding ligaments and tendons, effectively improving the joint gap, and thereby improving joint functions [46]. Meridian-sinew release therapy is also a mechanical process, and its mechanism of action may enhance local tissue functions and lymphatic circulation to speed up and improve metabolism in the diseased tissue. It may also enlarge interstitial fluid channels, enhancing the interstitial flow and reducing the fluid pressure, prompting the absorption of diseased tissue and substances. These lesions of absorption lead to local swelling, which further accelerates the interstitial-lymphatic circulation, thus speeding up the recovery from the disease [47].

The results from this study indicate that, compared with the acupuncture group and drug therapy group, patients in the meridian-sinew release therapy group showed more significant changes in the primary ending point pain, physiological function, ankylosis, and the total symptom score in the 12th week. The major limitation of this study was the small sample size because it was just a pilot case study.





FIGURE 6: Body fluid penetrating into the cavity and creating foam.

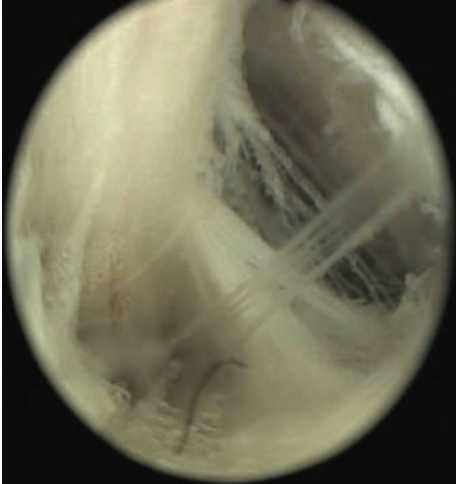

FIGURE 9: Fibroplasia.



FIGURE 7: Phlegm and blood stasis obstructing collaterals.



FIGURE 10: Fascial thickening.

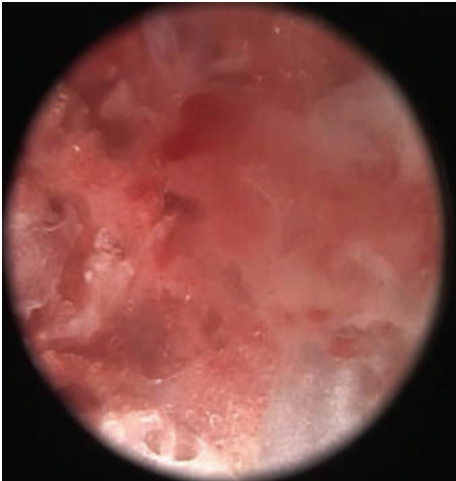

FIGURE 8: Coagulated phlegm, blood stasis, and foam.

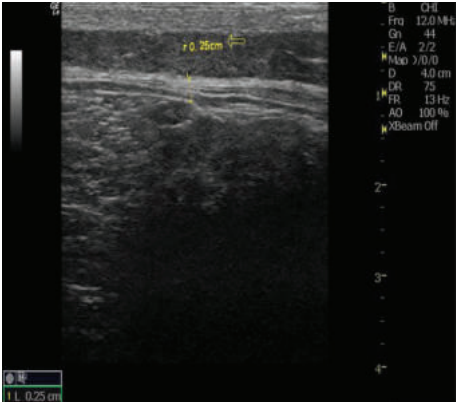

FIGURE 11: Fascia thickening under color doppler ultrasound.

A controlled study with a larger sample size will be done in the near future.

## 5. Conclusion

This preliminary study shows that meridian-sinew release therapy should be considered as a treatment for knee osteoarthritis. It is better than acupuncture and oral medication therapy. This therapy was shown to relieve joint pain and improve function without any adverse events during the entire study. It is a safe and effective treatment for knee osteoarthritis.

## Abbreviations

GDP:	Gross domestic product
ACR:	American College of Rheumatology
VAS:	Visual Analogue Scale
WOMAC:	The Western Ontario and McMaster University Osteoarthritis Index visual analogue scale
SF-36:	The MOS item short from health survey.

## Conflict of Interests

The authors declare that there is no conflict of interests.

## Authors' Contribution

S. Wei, Z. Chen, W. Sun, G. Zhang, X. Li, C. Hou, L. Lu, and L. Zhang contributed equally to this paper.

## Acknowledgments

This study was partially supported by the Plan Project of Science and Technology of Guangdong Province (no. 2011B050400040) and the Plan Project of Science and Technology of Guangzhou City (no. 11S76090020). The authors thank Dr. Dawei Wang for technical assistance and Guangzhou Yifudi Medical Devices Co. Ltd. for offering instrument aid.

## References

- [1] G. Peat, R. McCarney, and P. Croft, "Knee pain and osteoarthritis in older adults: a review of community burden and current use of primary health care," *Annals of the Rheumatic Diseases*, vol. 60, no. 2, pp. 91–97, 2001.
- [2] Centers for Disease Control and Prevention (CDC), "Prevalence of self-reported arthritis or chronic joint symptoms among adults—United States, 2001," *Morbidity and Mortality Weekly Report*, vol. 51, no. 42, pp. 948–950, 2002.
- [3] D. T. Felson and Y. Zhang, "An update on the epidemiology of knee and hip osteoarthritis with a view to prevention," *Arthritis & Rheumatism*, vol. 41, no. 8, pp. 1343–1355, 1998.
- [4] P. Sarzi-Puttini, M. A. Cimmino, R. Scarpa et al., "Osteoarthritis: an overview of the disease and its treatment strategies," *Seminars in Arthritis and Rheumatism*, vol. 35, no. 1, pp. 1–10, 2005.
- [5] R. C. Lawrence, C. G. Helmick, F. C. Arnett et al., "Estimates of the prevalence of arthritis and selected musculoskeletal disorders in the United States," *Arthritis & Rheumatism*, vol. 41, no. 5, pp. 778–799, 1998.
- [6] M. Blagojevic, C. Jinks, A. Jeffery, and K. P. Jordan, "Risk factors for onset of osteoarthritis of the knee in older adults: a systematic review and meta-analysis," *Osteoarthritis and Cartilage*, vol. 18, no. 1, pp. 24–33, 2010.
- [7] D. T. Felson, R. C. Lawrence, P. A. Dieppe et al., "Osteoarthritis: new insights. Part I: the disease and its risk factors," *Annals of Internal Medicine*, vol. 133, no. 8, pp. 635–646, 2000.
- [8] American College of Rheumatology Subcommittee on Osteoarthritis Guidelines, "Recommendations for the medical management of osteoarthritis of the hip and knee," *Arthritis & Rheumatism*, vol. 43, no. 9, pp. 1905–1915, 2000.
- [9] A. Pendleton, K.-P. Gunther, H. J. Hauselmann et al., "EULAR recommendations for the management of knee osteoarthritis: report of a task force of the standing committee for international clinical studies including therapeutic trials (ESCISIT)," *Annals of the Rheumatic Diseases*, vol. 59, no. 12, pp. 936–944, 2000.
- [10] G. A. Hawker, S. Mian, K. Bednis, and I. Stanaitis, "Osteoarthritis year 2010 in review: non-pharmacologic therapy," *Osteoarthritis and Cartilage*, vol. 19, no. 4, pp. 366–374, 2011.
- [11] D. T. Felson, R. C. Lawrence, M. C. Hochberg et al., "Osteoarthritis: new insights. Part 2: treatment approaches," *Annals of Internal Medicine*, vol. 133, no. 9, pp. 726–737, 2000.
- [12] M. I. Hamburger, S. Lakhanpal, P. A. Mooar, and D. Oster, "Intra-articular hyaluronans: a review of product-specific safety profiles," *Seminars in Arthritis and Rheumatism*, vol. 32, no. 5, pp. 296–309, 2003.
- [13] P. McGettigan and D. Henry, "Cardiovascular risk and inhibition of cyclooxygenase: a systematic review of the observational studies of selective and nonselective inhibitors of cyclooxygenase 2," *Journal of the American Medical Association*, vol. 296, no. 13, pp. 1633–1644, 2006.
- [14] A. L. Blower, A. Brooks, G. C. Fenn et al., "Emergency admissions for upper gastrointestinal disease and their relation to NSAID use," *Alimentary Pharmacology and Therapeutics*, vol. 11, no. 2, pp. 283–291, 1997.
- [15] M. Fu and Z. Zhang, "Knee osteoarthritis treated with acupuncture at the points selected according to syndrome differentiation: a randomized controlled trial," *Chinese Acupuncture & Moxibustion*, vol. 31, no. 12, pp. 1062–1066, 2011.
- [16] Z. G. Liao and L. B. Fei, "Medicine fumigation combined with acupuncture treatment of knee osteoarthritis scrutiny," *Chinese Journal of Clinical Medicine*, vol. 18, no. 3, pp. 27–28, 2010.
- [17] Y. Qi and Z. J. Hao, "Acupuncture treatment of knee osteoarthritis clinical efficacy observed," *Shanxi University of Chinese Medicine*, vol. 30, no. 6, pp. 43–44, 2007.
- [18] L. L. Liu, "Electro-acupuncture treatment of knee joint 150 Cases," *Chinese Medical Journal*, vol. 3, no. 5, pp. 436–437, 2004.
- [19] S. Wei, W. F. Sun, and Z. H. Chen, "40 patients of rheumatoid arthritis treated by Fascia-meridian scope," *Chinese Journal of Clinical Care*, vol. 14, no. 4, pp. 413–415, 2011.
- [20] S. Wei, Y. Qiu, Z. H. Chen, and M. C. Xu, "Minimally invasive expansion lysis treatment of supraspinatus tendinitis," *Chinese Journal of Orthopedics and Traumatology of Chinese Medicine*, vol. 15, no. 3, p. 35, 2007.
- [21] Z. H. Chen, S. Wei, and W. F. Sun, "Clinical observation of 80 cases of knee osteoarthritis treated with traditional Fascia-meridian scope," *Chinese Journal of Guiyang College of Traditional Chinese Medicine*, vol. 22, no. 5, pp. 56–57, 2011.

- [22] S. Wei, W. F. Sun, and Z. H. Chen, "Chinese minimally invasive needle mirror analysis of 121 cases of application in local intractable pain syndrome in China," *Journal of Misdiagnosis*, vol. 11, no. 9, pp. 2188–2189, 2011.
- [23] M. T. Lin, L. W. Chou, H. S. Chen et al., "Percutaneous soft tissue release for treating chronic recurrent myofascial pain associated with lateral epicondylitis: 6 case studies," *Evidence-Based Complementary and Alternative Medicine*, vol. 2012, Article ID 142941, 7 pages, 2012.
- [24] N. Bellamy, A. Klestov, K. Muirden et al., "Perceptual variation in categorizing individuals according to American College of Rheumatology classification criteria for hand, knee, and hip osteoarthritis (OA): observations based on an Australian Twin Registry study of OA," *Journal of Rheumatology*, vol. 26, no. 12, pp. 2654–2658, 1999.
- [25] R. Altman, E. Asch, and D. Bloch, "Development of criteria for the classification and reporting of osteoarthritis. Classification of osteoarthritis of the knee," *Arthritis and Rheumatism*, vol. 29, no. 8, pp. 1039–1052, 1986.
- [26] C. J. Menkes, "Radiographic criteria for classification of osteoarthritis," *Journal of Rheumatology*, vol. 18, supplement 27, pp. 13–15, 1991.
- [27] J. B. Carlin and L. W. Doyle, "Statistics for clinicians 7: sample size," *Journal of Paediatrics and Child Health*, vol. 38, no. 3, pp. 300–304, 2002.
- [28] L. G. Xue, *China Fascia-Meridian Learning*, vol. 8, Publishing House of Ancient Books of China, Beijing, China, 2009.
- [29] C. Witt, B. Brinkhaus, S. Jena et al., "Acupuncture in patients with osteoarthritis of the knee: a randomised trial," *The Lancet*, vol. 366, no. 9480, pp. 136–143, 2005.
- [30] N. Bellamy, W. W. Buchanan, C. H. Goldsmith, J. Campbell, and L. W. Stitt, "Validation study of WOMAC: a health status instrument for measuring clinically important patient relevant outcomes to antirheumatic drug therapy in patients with osteoarthritis of the hip or knee," *Journal of Rheumatology*, vol. 15, no. 12, pp. 1833–1840, 1988.
- [31] G. M. Davies, D. J. Watson, and N. Bellamy, "Comparison of the responsiveness and relative effect size of the Western Ontario and McMaster Universities Osteoarthritis Index and the short-form medical outcomes study survey in a randomized, clinical trial of osteoarthritis patients," *Arthritis Care and Research*, vol. 12, no. 3, pp. 172–179, 1999.
- [32] W. Häuser, C. Zimmer, P. Schiedermaier, and D. Grandt, "Biopsychosocial predictors of health-related quality of life in patients with chronic hepatitis C," *Psychosomatic Medicine*, vol. 66, no. 6, pp. 954–958, 2004.
- [33] J. N. Katz, M. G. Larson, C. B. Phillips, A. H. Fossel, and M. H. Liang, "Comparative measurement sensitivity of short and longer health status instruments," *Medical Care*, vol. 30, no. 10, pp. 917–925, 1992.
- [34] J. Karlsson, L. S. Sjögren, and L. S. Lohmander, "Comparison of two hyaluronan drugs and placebo in patients with knee osteoarthritis. A controlled, randomized, double-blind, parallel-design multicentre study," *Rheumatology*, vol. 41, no. 11, pp. 1240–1248, 2002.
- [35] A. White, N. E. Foster, M. Cummings, and P. Barlas, "Acupuncture treatment for chronic knee pain: a systematic review," *Rheumatology*, vol. 46, no. 3, pp. 384–390, 2007.
- [36] E. Miller, Y. Maimon, Y. Rosenblatt et al., "Delayed effect of acupuncture treatment in OA of the knee: a blinded, randomized, controlled trial," *Evidence-Based Complementary and Alternative Medicine*, vol. 2011, Article ID 792975, 5 pages, 2011.
- [37] W. Zhang, R. W. Moskowitz, G. Nuki et al., "OARSI recommendations for the management of hip and knee osteoarthritis. Part II: OARSI evidence-based, expert consensus guidelines," *Osteoarthritis and Cartilage*, vol. 16, no. 2, pp. 137–162, 2008.
- [38] L. G. Xue, "China aponeurotic theory," *Chinese Acupuncture and Moxibustion*, vol. 20, no. 11, pp. 698–699, 1997.
- [39] R. Zhang, F. Li, H. C. Wang et al., "The effect of Fascia-meridian theory in the pathogenesis of arthritis and treatment of osteoarthritis of the knee," *Chinese Journal of Rehabilitation Medicine*, vol. 22, no. 7, pp. 644–646, 2007.
- [40] J. Ye and Z. H. Guan, "Guan zunhui teacher experience on applying Fascia-meridian theory," *Yunnan Journal of Traditional Chinese Medicine*, vol. 26, no. 3, pp. 2–3, 2005.
- [41] J. Pang, Y. Y. Shi, Y. I. Cao et al., "The recognition of Chinese medicine osteoarthritis of knee," *Journal of Shanghai University of Traditional Chinese Medicine*, vol. 25, no. 1, pp. 26–28, 2011.
- [42] W. Y. Li, "Apply acupuncture method to treat Fascia-meridian disease," *Journal of Clinical Acupuncture and Moxibustion*, vol. 12, pp. 5–7, 2004.
- [43] Y. Cheng, "The essence of Fascia-meridian, machine and treatment of disease ribs," *Hunan Journal of Traditional Chinese Medicine*, vol. 27, no. 5, pp. 97–99, 2011.
- [44] W. B. Zhang, Y. Y. Tian, H. Li et al., "A discovery of low hydraulic resistance channel along meridians," *JAMS Journal of Acupuncture and Meridian Studies*, vol. 1, no. 1, pp. 20–28, 2008.
- [45] L. G. Xue, H. R. Zhang, C. S. Liu et al., "Apply Fascia-meridian to diagnosis and Treatment of knee degenerative changes associated with knee pain in 364 cases analysis," *Journal of Traditional Chinese Medicine*, vol. 21, no. 8, pp. 1377–1378, 2003.
- [46] R. S. Fife, K. D. Brandt, E. M. Braunstein et al., "Relationship between arthroscopic evidence of cartilage damage and radiographic evidence of joint space narrowing in early osteoarthritis of the knee," *Arthritis and Rheumatism*, vol. 34, no. 4, pp. 377–382, 1991.
- [47] B. Z. Liu, "Acupotomy," *Clinical Medicine of China*, vol. 28, no. 1, p. 2, 2000.

## Research Article

# Acupuncture Activates ERK-CREB Pathway in Rats Exposed to Chronic Unpredictable Mild Stress

Jun Lu,<sup>1</sup> Jia Liang,<sup>2</sup> Jun-Ren Wang,<sup>3</sup> Li Hu,<sup>1</sup> Ya Tu,<sup>1</sup> and Jian-You Guo<sup>4</sup>

<sup>1</sup> School of Acupuncture-Moxibustion and Tui Na, Beijing University of Chinese Medicine, Beijing 100029, China

<sup>2</sup> Graduate School of China Academy of Chinese Medical Sciences, Beijing 100700, China

<sup>3</sup> Beijing Heping Hospital of Chaoyang District, Beijing 100103, China

<sup>4</sup> Key Laboratory of Mental Health, Institute of Psychology, Chinese Academy of Sciences, Beijing 100101, China

Correspondence should be addressed to Ya Tu; tuyab@263.net and Jian-You Guo; guojy@psych.ac.cn

Received 28 March 2013; Revised 21 May 2013; Accepted 29 May 2013

Academic Editor: Gerhard Litscher

Copyright © 2013 Jun Lu et al. This is an open access article distributed under the Creative Commons Attribution License, which permits unrestricted use, distribution, and reproduction in any medium, provided the original work is properly cited.

Extracellular signal-regulated kinase (ERK)-cAMP response element binding protein (CREB) signal pathway has been implicated in the pathogenesis of depression. There is growing evidence that acupuncture in traditional Chinese medicine has antidepressant-like effect. However, the effect of acupuncture on ERK-CREB pathway remains unknown. In our study, the antidepressant-like effect of acupuncture treatment was measured by sucrose intake test and open field test in rats exposed to chronic unpredictable mild stress (CUMS) for 4 weeks. The protein levels of ERK1/2, CREB, phosphorylated ERK1/2 (p-ERK1/2), and phosphorylated CREB (p-CREB) in the hippocampus (HP) and prefrontal cortex (PFC) were examined by Western blot analysis. Our results showed that CUMS rats exhibited the reduction in behavioral activities, whereas acupuncture stimulation at acupoints Baihui (Du20) and Neiguan (PC6) reversed the behavioral deficit. In addition, exposure to CUMS resulted in the decrease of p-ERK1/2 and p-CREB in the HP and PFC. Acupuncture increased the ratio of p-ERK1/2 to ERK1/2 and the ratio of p-CREB to CREB in the HP and PFC. Our study suggested that one potential way, by which acupuncture had antidepressant-like effect, might be mediated by activating the ERK-CREB pathway in the brain.

## 1. Introduction

Depression is the leading cause of disability and the 4th leading contributor to the global burden of disease in the world, with a lifetime prevalence of up to 17% [1]. Although antidepressant medications represent the mainstay treatment for depression, almost one-fourth of patients fail to respond to the treatment [2]. Attempts have been made to seek alternative medicine for treatment options [3]. In Chinese medicine, acupuncture has been widely used to treat depression [4, 5]. However, the mechanism underlying the acupuncture treatment in depression remains unclear.

The extracellular signal-regulated kinase (ERK)-cAMP response element binding protein (CREB) signal pathway is implicated in learning, memory, and neuroplasticity [6] and plays an important role in regulating many brain functions, including cell growth, differentiation, apoptosis, and cellular

responses to stress [7]. It has been reported that ERK-CREB signal pathway involves in stress response and depression [8]. For example, previous reports have indicated that chronic stress reduced phosphorylated ERK (p-ERK) and phosphorylated CREB (p-CREB) expression in rat brain [9, 10]. However, little is known about whether acupuncture could affect ERK-CREB signal pathway in stress and depression.

Therefore, the primary goal of the present study was to evaluate the effect of acupuncture on ERK-CREB signal pathway in a chronic unpredictable mild stress (CUMS) rat model of depression. The model is a widely accepted rodent model of depression, which employs various stressors to mimic some symptoms of depression in humans [11]. We investigated the effects of acupuncture on the behavioral activities and detected protein levels of ERK1/2, CREB, p-ERK1/2, and p-CREB in the hippocampus (HP) and prefrontal cortex (PFC) by using Western blot analysis. The HP and PFC are thought

to be involved in reward and affective circuitry and play a major role in mood regulation and the pathophysiology of depression [12, 13].

## 2. Materials and Methods

**2.1. Animals.** Male Sprague-Dawley rats (180~200 g) were obtained from Beijing Vital River Laboratories. Rats were kept in an air-conditioned room with a 12 h light/dark cycle with free access to food and water except when animals were subjected to deprivation stressors as described in stress. The experiment procedures were approved by the Animal Care and Use Committee at Beijing University of Chinese Medicine.

**2.2. Groups and Treatment.** The rats were randomly divided into five groups (ten rats in each group): the Normal group was given no stress except general handling for 4 weeks; the Normal + Acu group was treated with the same as the Normal group but with acupuncture stimulation; the CUMS group was exposed to CUMS for 4 weeks; the CUMS + Acu group received acupuncture treatment once every other day during the 4-week stress period; the CUMS + Paroxetine (Par) group, used as a positive comparator for an antidepressant effect, was given once daily oral gavage (p.o.) administration of Paroxetine (10 mg/kg, GSK Co., Ltd, China) during the 4-week stress period. Paroxetine was diluted in distilled water and orally given one hour before the stress exposure. The dosage of 10 mg/kg for paroxetine has been reported to show antidepressant action in previous work [14, 15].

**2.3. Chronic Unpredictable Mild Stress Procedure.** Rats in stressed groups were exposed to CUMS after 1 week of acclimatization period under the housing conditions. The CUMS model was modified from the methods previously described [11, 16]. Six different stressors were used to induce a depressive state, including food deprivation (24 h), water deprivation (24 h), cold water swimming (4°C, 5 min), cage shaken on a rocking bed (30 min; ZD-9556, manufactured in Taicang Scientific Instruments Limited, China), behavior restraint on a restraining device (3 h), and tail clip (2 min). These stressors lasted for 4 weeks, and a different stressor was administered on each day. The tail clip was used twice in a week. For example, the following stressors were arranged in one week: Day 1 swim, Day 2 tail clip, Day 3 food deprivation, Day 4 shaken on a rocking bed, Day 5 restraint, Day 6 tail clip, and Day 7 water deprivation. The stressors were arranged semirandomly to make the last stressor be water deprivation. The stress sequence was changed every week in order to make the stress procedure unpredictable.

**2.4. Acupuncture Treatment.** During acupuncture administration, the rats were maintained within a cloth bag with one forelimb taken out by an assistant, similar to what we described previously [17]. Sterilized disposable stainless steel needles of 0.3 mm diameter were inserted as deep as 2-3 mm at Baihui (GV20) and Neiguan (PC6). GV20 is located above the apex auriculate, on the midline of the head. PC6

is located between the tendons of m. palmaris longus and m. flexor carpi radialis, proximal to the transverse crease of the wrist. The acupuncture treatment was manually delivered by twisting the acupuncture needles at a frequency of twice per second for 1 minute, and then the needles were retained for 10 minutes. The rats received acupuncture treatment once every other day during the 4-week period.

**2.5. Behavior Tests.** The sucrose intake test was a modified version from the literature [18, 19]. The 5% sucrose solution was previously described [19]. Before the test, the rats were habituated to consume 5% sucrose solution for 24 h without any water available. On the last stressed day, the rats were deprived of water for 24 h. Then the rats were given a 1 h window sucrose test (between 14:00 and 15:00 h). The sucrose consumption was measured by reweighing preweighed bottles of sucrose solution.

At the end of the experiment, the open field test was performed. The apparatus consisted of a square arena 80 × 80 cm with 40 cm high wall. It was divided into 25 × 25 equal squares which had been drawn in the floor of the arena. A single rat was gently placed in the center of the floor in order to explore the arena for 5 min. The crossing numbers (defined as at least three paws in a square) and the rearing numbers (defined as the rat standing upright on its hind legs) were counted manually by two observers who were blind to the experiment. The body weight was measured on day 1 and day 28 of the experiment.

**2.6. Western Blot Analysis.** After the behavioral tests were completed, six rats in each group were sacrificed by decapitation for Western blot analysis. Then the HP and PFC were dissected and put into chilled tubes treated with an enzyme inhibitor. Brain tissue was homogenized and Western blot analysis carried out as previously reported [20], using primary antibodies for rabbit ERK1/2, rabbit p-ERK1/2, rabbit CREB, rabbit p-CREB, and  $\beta$ -actin at 1:1000 dilution (Santa Cruz Biotech Inc., CA, USA). A secondary antibody conjugated with horseradish peroxidase was used. Immunoreactivity was visualized by ECL reagent. ERK1/2, p-ERK1/2, CREB, and p-CREB protein expression were quantified by densitometry using the Scion Image Beta 4.02 software and are shown as density relative to  $\beta$ -actin.

**2.7. Statistical Analysis.** Data were presented as means  $\pm$  S.E.M. Differences among groups were examined using one-way ANOVA, followed by Newman-Keuls test.  $P < 0.05$  was the accepted level of significance.

## 3. Results

**3.1. Effects of Acupuncture Treatment on the Body Weight.** As shown in Figure 1(a). At the beginning of the experiment, there was no significant difference among groups in the body weight [ $F_{(4,45)} = 0.90, P > 0.05$ ]. After 28-day stress procedure, significant difference was observed among groups [ $F_{(4,45)} = 21.35, P < 0.01$ ]. The CUMS rats showed a significant decrease of the body weight compared to normal

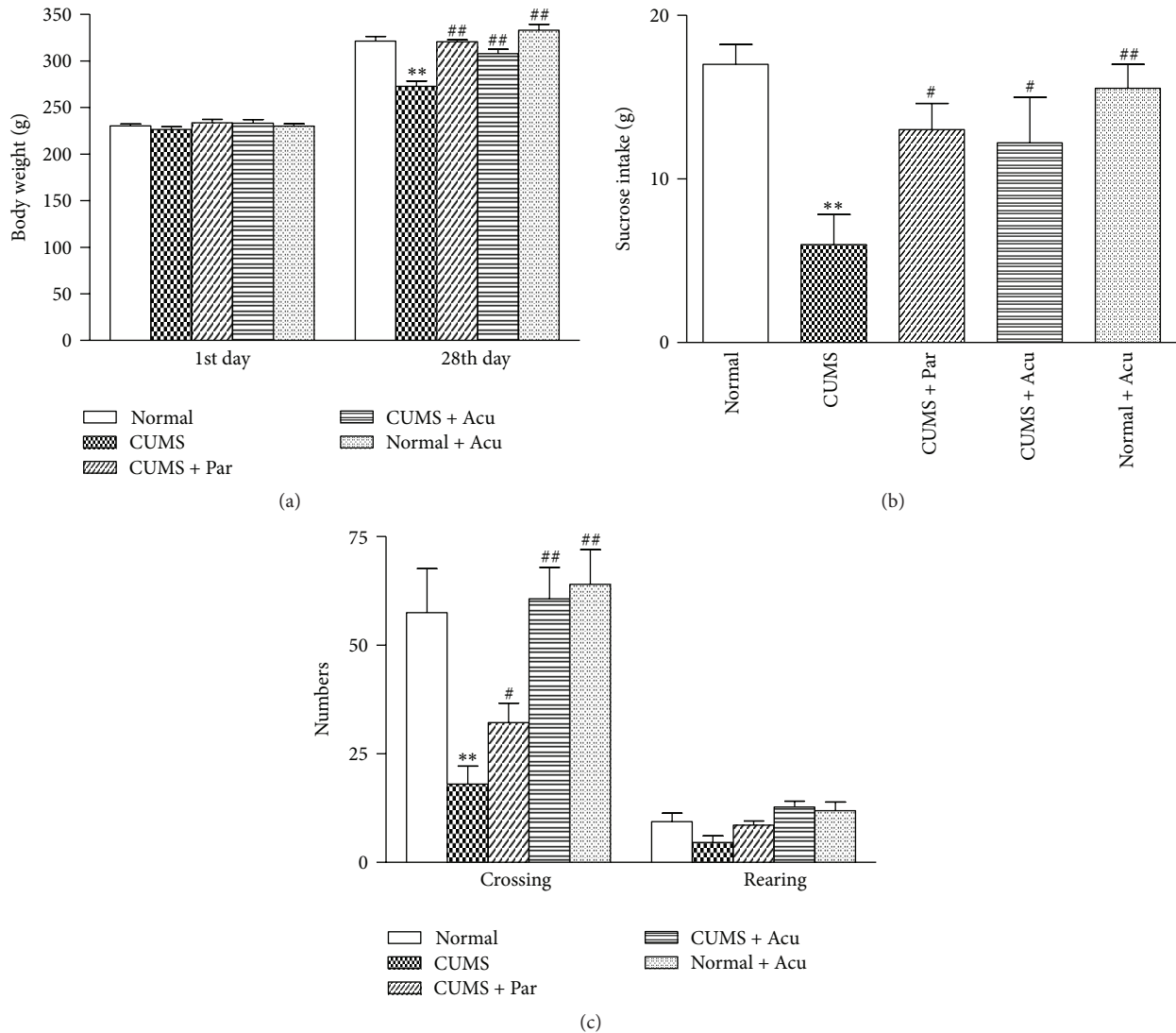

FIGURE 1: The effect of acupuncture on body weight, sucrose intake test, and locomotor activity in open field test in the following groups ( $n = 10$  per group): Normal, CUMS, CUMS + Par, CUMS + Acu, and Normal + Acu. (a) Body weight. (b) Sucrose intake test. (c) Open field test. \*\* $P < 0.01$  as compared with the Normal group, # $P < 0.05$ , ## $P < 0.01$  as compared with the CUMS group.

rat ( $P < 0.01$ ). Acupuncture treatment and paroxetine had significant effect on the decrease in the body weight ( $P < 0.01$ , either). There was no significant difference in the body weight between the normal rats and Normal + Acu rats ( $P > 0.05$ ), suggesting that acupuncture had no effect on the body weight in normal rats.

**3.2. Effects of Acupuncture Treatment on the Sucrose Intake Test.** The sucrose intake test is used to predict sensitivity to rewards [21]. As seen in Figure 1(b), the sucrose solution intake significantly differed among groups after stress procedure [ $F_{(4,45)} = 5.23$ ,  $P < 0.01$ ]. The sucrose intake was significantly reduced in CUMS group compared to Normal group ( $P < 0.01$ ), suggesting the anhedonia was induced by CUMS. Paroxetine and acupuncture treatment increased the decrease in sucrose intake caused by CUMS ( $P < 0.05$ ,

either), which is indicative of an increasing rewarding effect of sucrose solution after treatment. There was no significant difference in the sucrose solution intake between the normal rats and Normal + Acu rats ( $P > 0.05$ ), suggesting that acupuncture treatment had no effect on the sucrose solution intake in the naive rats.

**3.3. Effects of Acupuncture Treatment on the Open Field Test.** The open field test was used to study the exploratory and locomotor activity [22, 23]. As seen in Figure 1(c), in the open field test, there was significant difference among groups in the number of crossings after stress procedure [ $F_{(4,45)} = 8.03$ ,  $P < 0.01$ ]. In comparison to normal rats, CUMS rats showed a significant reduction of crossings ( $P < 0.01$ ) but not rearings ( $P > 0.05$ ). Acupuncture treatment and paroxetine improved the locomotor activity decreased by CUMS ( $P < 0.01$ ,  $0.05$ ,

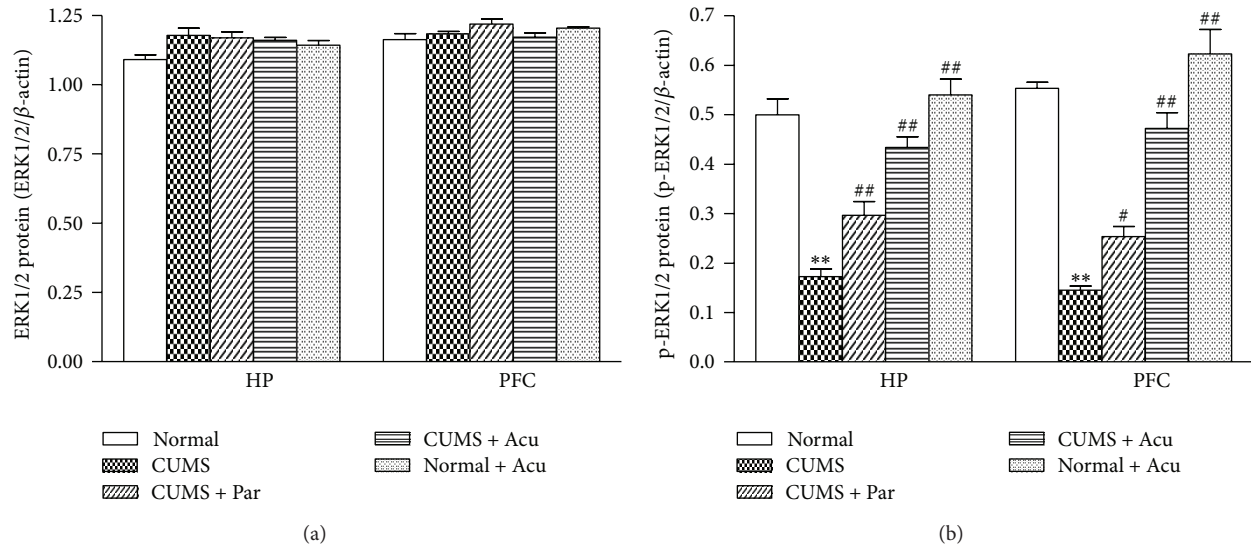

FIGURE 2: The effect of acupuncture on ERK1/2 and p-ERK1/2 protein expression in hippocampus (HP) and prefrontal cortex (PFC) in the following groups ( $n = 6$  per group): Normal, CUMS, CUMS + Par, CUMS + Acu, and Normal + Acu. (a) ERK1/2; (b) p-ERK1/2. \*\*  $P < 0.01$  as compared with the Normal group, #  $P < 0.05$ , ##  $P < 0.01$  as compared with the CUMS group.

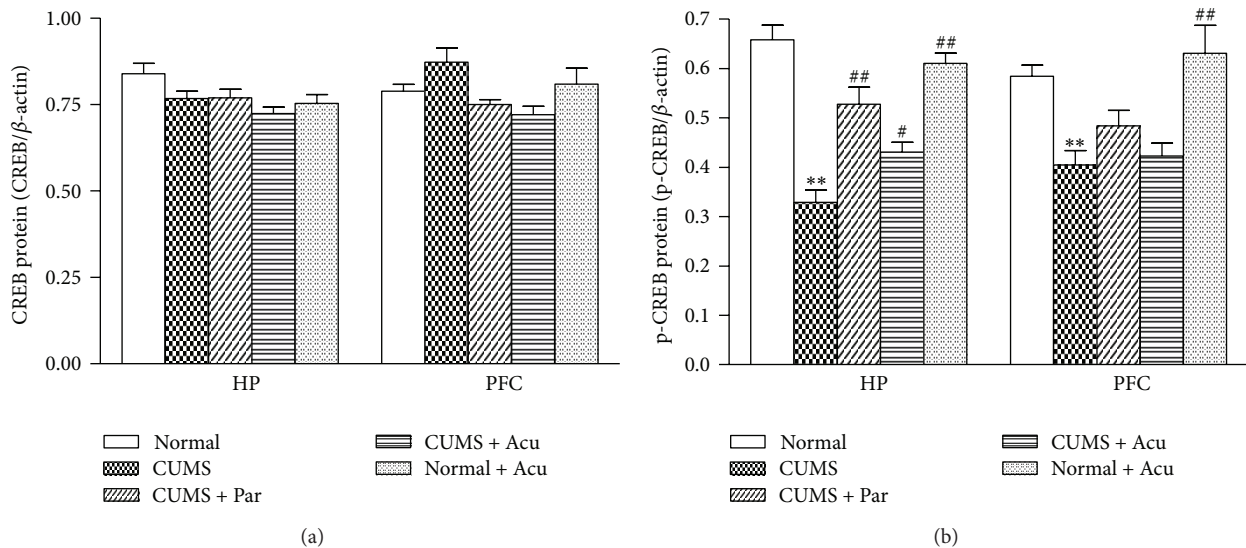

FIGURE 3: The effect of acupuncture on CREB and p-CREB protein expression in hippocampus (HP) and prefrontal cortex (PFC) in the following groups ( $n = 6$  per group): Normal, CUMS, CUMS + Par, CUMS + Acu, and Normal + Acu. (a) CREB; (b) p-CREB. \*\*  $P < 0.01$  as compared with the Normal group, #  $P < 0.05$ , ##  $P < 0.01$  as compared with the CUMS group.

resp.). There was no significant difference in the rearings between the normal rats and CUMS rats ( $P > 0.05$ ). There was no significant difference in the crossings between the normal rats and Normal + Acu rats ( $P > 0.05$ ), suggesting that acupuncture treatment had no effect on the locomotor activity in the naive rats.

**3.4. Effects of Acupuncture Treatment on the ERK1/2 and p-ERK1/2 Levels in the HP and PFC.** Western blot analysis revealed that there was no significant difference in the ERK1/2 protein level among groups in the HP [ $F_{(4,25)} = 3.44$ ,

$P > 0.05$ ] and the PFC [ $F_{(4,25)} = 2.17$ ,  $P > 0.05$ ], as seen in Figures 2(a) and 4. However, p-ERK1/2 level significantly differed among groups in the HP [ $F_{(4,25)} = 32.02$ ,  $P < 0.01$ ] and PFC [ $F_{(4,25)} = 49.71$ ,  $P < 0.01$ ]. Chronic stress significantly decreased p-ERK1/2 in the HP ( $P < 0.01$ ) and PFC ( $P < 0.01$ ) compared to Normal group. Acupuncture treatment and paroxetine significantly increased p-ERK1/2 level in HP ( $P < 0.01$ , either) and PFC ( $P < 0.01$ , either). There was no significant difference in p-ERK1/2 between the Normal and Normal + Acu groups, suggesting that acupuncture had no effect on ERK1/2 activity in the naive rats, as seen in Figures 2(b) and 4.

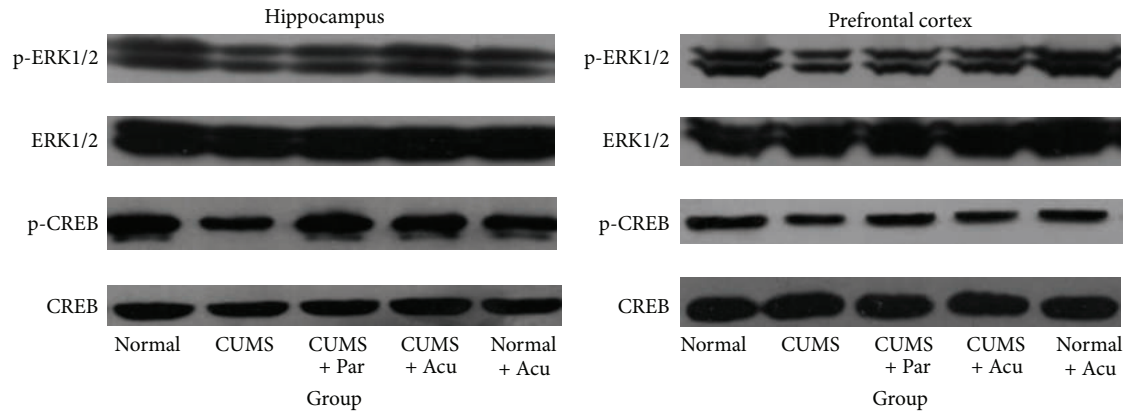

FIGURE 4: Representative Western blots showing levels of p-ERK1/2, ERK1/2, p-CREB, and CREB in the hippocampus and prefrontal cortex of the following groups ( $n = 6$  per group): Normal, CUMS, CUMS + Par, CUMS + Acu, and Normal + Acu.

**3.5. Effects of Acupuncture Treatment on the CREB and p-CREB Levels in the HP and PFC.** The CREB protein level did not significantly differ among groups in the HP [ $F_{(4,25)} = 3.08$ ,  $P > 0.05$ ] and the PFC [ $F_{(4,25)} = 3.39$ ,  $P > 0.05$ ], as seen in Figures 3(a) and 4. However, p-CREB protein level significantly differed among groups in the HP [ $F_{(4,25)} = 24.98$ ,  $P < 0.01$ ] and PFC [ $F_{(4,25)} = 7.83$ ,  $P < 0.05$ ]. Chronic stress significantly decreased p-CREB in the HP and PFC ( $P < 0.01$ , either) compared to Normal group. Acupuncture treatment and paroxetine significantly increased the p-CREB level in HP ( $P < 0.01$ ,  $0.05$ , resp.) but not in PFC ( $P > 0.05$ ), as seen in Figures 3(b) and 4.

## 4. Discussion

The major finding of the present study is that chronic stress exposure caused deficits in ERK and CREB activation in the HP and PFC, which could be reversed by acupuncture treatment. We also found that the behavior deficits induced by chronic stress were restored by acupuncture. Our results suggested that acupuncture could activate ERK-CREB pathway in the rats exposed to CUMS, which might mediate the antidepressant-like effect of acupuncture.

The ERK-CREB signal pathway has been studied for its role in stress and depression [8, 24]. For example, preclinical studies have suggested that depression was associated with aberrant ERK signal pathway [25]. Chronic stress exposure caused the reduction in p-ERK and p-CREB in the HP of rat [9, 10]. On the other hand, controversial studies exist. For example, it has been reported that 14-day stress induced an increase in p-ERK1/2 and p-CREB in the HP [26]. The possible explanation for the discrepancy may lie in the difference in stress category, duration, and other experimental procedures.

In consistency with most of these previous findings, we found that CUMS decreased p-ERK1/2 and p-CREB levels in the HP and PFC, without affecting ERK1/2 and CREB. It is well accepted that one of the most important properties of ERK1/2 activation is that it must be phosphorylated to exhibit full enzymatic activity. After activation, ERK induces nuclear translocation and phosphorylation of target transcription

factors. CREB has been known to be a downstream of ERK and a critical transcription factor in regulating diverse processes such as neurodevelopment, neuronal plasticity, and survival [27–29]. ERK activation is necessary to induce the phosphorylation of the CREB and modulation of its transcriptional activity [30]. Therefore, it is suggested that chronic stress exposure caused deficits in ERK and CREB activation and inhibited ERK-CREB pathway in the brain, which could be implicated in depression.

Phosphorylation of ERK1/2 and CREB has been thought to be an intracellular signal mechanism mediating antidepressant effect [31, 32]. It has been found that antidepressants increased p-ERK and p-CREB in rats exposed to chronic stress [33]. In accordance with the previous results, our findings showed that acupuncture treatment increased p-ERK1/2 in the HP and PFC of CUMS rats and increased p-CREB in the HP. Our data showed that the ratio of p-CREB to CREB in the PFC and HP was significantly higher in CUMS + Acu group than that of CUMS rats (PFC:  $0.59 \pm 0.04$  versus  $0.46 \pm 0.02$ ,  $P < 0.05$ ; HP:  $0.60 \pm 0.03$  versus  $0.43 \pm 0.03$ ,  $P < 0.05$ ). Similarly, we found that acupuncture significantly increased the ratio of p-ERK to ERK in the PFC and HP when compared to CUMS rats (PFC:  $0.40 \pm 0.16$  versus  $0.12 \pm 0.04$ ,  $P < 0.01$ ; HP:  $0.37 \pm 0.15$  versus  $0.14 \pm 0.06$ ,  $P < 0.01$ ). Our results suggested that the upregulation of CREB activation is accompanied by the increase of ERK activation, which may suggest a role of the ERK-CREB pathway in the chronic effect of acupuncture.

We previously found that acupuncture increased the brain-derived neurotrophic factor (BDNF) protein level in the HP and PFC of rats exposed to chronic stress [34]. Phosphorylation of CREB is implicated in synaptic plasticity and regulates the transcription of the downstream genes encoding proteins, such as BDNF, c-fos, and many neuropeptides [35]. It is reasonable to speculate that there is a potential for acupuncture to influence BDNF expression and neuronal function by activating ERK-CREB pathway.

In the present study, we found that acupuncture treatment slightly increased the protein levels of p-ERK1/2 and p-CREB in normal rats. Therefore, the traditional medicine



acupuncture treatment seemed to induce a stimulation effect on the experimental animals, and traditional medicine might be beneficial in normal rat. Consistent with this finding, our previous study also showed that traditional medicine moxibustion might mildly affect the serum cytokines levels in control rat [17].

Paroxetine, a kind of selective serotonin reuptake inhibitors, is a clinically effective antidepressant drug. In accordance with previous finding [15], our results showed that paroxetine alleviated anhedonia induced by chronic stress. In addition, we found that paroxetine increased the levels of p-ERK1/2 and p-CREB in the hippocampus and PFC, which could partially mediate the antidepressant effect of paroxetine.

In the present study, the acupuncture was applied under a lightly restrained condition. Our previous work (data not published) showed that there was no significant difference in serum adrenocorticotrophic hormone (ACTH) and corticosterone (Cort) level between the normal rats and Normal + Acu rats. It is suggested that the acupuncture administration will not induce stress response.

## 5. Conclusions

In conclusion, we found that chronic stress exposure decreased p-ERK1/2 and p-CREB in the rat brain and induced deficits in ERK1/2 and CREB activation. In addition, acupuncture treatment could activate ERK-CREB pathway and alleviate depressive-like behavior. Our results suggested that the antidepressant-like effect of acupuncture might be mediated by activating the ERK-CREB pathway in the brain.

## Authors' Contribution

Jun Lu and Jia Liang contribute equally to this study.

## Acknowledgments

This study was supported by the Grants from the National Natural Science Foundation of China (no. 81173334, 81102638, and 31170992), Foundation of the Ministry of Education of China (no. 20110013110009), the Dissertation Tutor Program of Beijing (no. YB20091002601), and the Young Researcher Foundation of Beijing University of Chinese Medicine (no. 2011JYBZZ-JS067).

## References

- [1] R. C. Kessler, P. Berglund, O. Demler, R. Jin, K. R. Merikangas, and E. E. Walters, "Lifetime prevalence and age-of-onset distributions of DSM-IV disorders in the national comorbidity survey replication," *Archives of General Psychiatry*, vol. 62, no. 6, pp. 593–602, 2005.
- [2] B. Arroll, S. Macgillivray, S. Ogston et al., "Efficacy and tolerability of tricyclic antidepressants and SSRIs compared with placebo for treatment of depression in primary care: a meta-analysis," *Annals of Family Medicine*, vol. 3, no. 5, pp. 449–456, 2005.
- [3] G. van der Watt, J. Laugharne, and A. Janca, "Complementary and alternative medicine in the treatment of anxiety and depression," *Current Opinion in Psychiatry*, vol. 21, no. 1, pp. 37–42, 2008.
- [4] J.-H. Liu, Z.-F. Wu, J. Sun, L. Jiang, S. Jiang, and W.-B. Fu, "Role of AC-cAMP-PKA cascade in antidepressant action of electroacupuncture treatment in rats," *Evidence-Based Complementary and Alternative Medicine*, vol. 2012, Article ID 932414, 7 pages, 2012.
- [5] J. Yang, Y. Pei, Y.-L. Pan et al., "Enhanced antidepressant-Like effects of electroacupuncture combined with citalopram in a rat model of depression," *Evidence-Based Complementary and Alternative Medicine*, vol. 2013, Article ID 107380, 12 pages, 2013.
- [6] C. Mazzucchelli and R. Brambilla, "Ras-related and MAPK signalling in neuronal plasticity and memory formation," *Cellular and Molecular Life Sciences*, vol. 57, no. 4, pp. 604–611, 2000.
- [7] P. P. Roux and J. Blenis, "ERK and p38 MAPK-activated protein kinases: a family of protein kinases with diverse biological functions," *Microbiology and Molecular Biology Reviews*, vol. 68, no. 2, pp. 320–344, 2004.
- [8] X. Qi, W. Lin, D. Wang, Y. Pan, W. Wang, and M. Sun, "A role for the extracellular signal-regulated kinase signal pathway in depressive-like behavior," *Behavioural Brain Research*, vol. 199, no. 2, pp. 203–209, 2009.
- [9] D. Laifenfeld, R. Karry, E. Grauer, E. Klein, and D. Ben-Shachar, "Antidepressants and prolonged stress in rats modulate CAM-11, laminin, and pCREB, implicated in neuronal plasticity," *Neurobiology of Disease*, vol. 20, no. 2, pp. 432–441, 2005.
- [10] J. Grønli, C. Bramham, R. Murison et al., "Chronic mild stress inhibits BDNF protein expression and CREB activation in the dentate gyrus but not in the hippocampus proper," *Pharmacology Biochemistry and Behavior*, vol. 85, no. 4, pp. 842–849, 2006.
- [11] P. Willner, A. Towell, D. Sampson, S. Sophokleous, and R. Muscat, "Reduction of sucrose preference by chronic unpredictable mild stress, and its restoration by a tricyclic antidepressant," *Psychopharmacology*, vol. 93, no. 3, pp. 358–364, 1987.
- [12] A. L. Brody, M. W. Barsom, R. G. Bota, and S. Saxena, "Prefrontal-subcortical and limbic circuit mediation of major depressive disorder," *Seminars in Clinical Neuropsychiatry*, vol. 6, no. 2, pp. 102–112, 2001.
- [13] J. D. Sweatt, "Hippocampal function in cognition," *Psychopharmacology*, vol. 174, no. 1, pp. 99–110, 2004.
- [14] C. K. Thoeringer, A. Erhardt, I. Sillaber et al., "Long-term anxiolytic and antidepressant-like behavioural effects of tiagabine, a selective GABA transporter-1 (GAT-1) inhibitor, coincide with a decrease in HPA system activity in C57BL/6 mice," *Journal of Psychopharmacology*, vol. 24, no. 5, pp. 733–743, 2010.
- [15] P. C. Casarotto and R. Andreatini, "Repeated paroxetine treatment reverses anhedonia induced in rats by chronic mild stress or dexamethasone," *European Neuropsychopharmacology*, vol. 17, no. 11, pp. 735–742, 2007.
- [16] J. Li, Y. Zhou, B.-B. Liu et al., "Nobiletin ameliorates the deficits in hippocampal BDNF, TrkB, and synapsin I induced by chronic unpredictable mild stress," *Evidence-Based Complementary and Alternative Medicine*, vol. 2013, Article ID 359682, 11 pages, 2013.
- [17] J. Lu, H.-L. Zhang, Z.-Z. Yin et al., "Moxibustion attenuates inflammatory response to chronic exhaustive exercise in rats," *International Journal of Sports Medicine*, vol. 33, no. 7, pp. 580–585, 2012.
- [18] H. Kim, H.-J. Park, S.-M. Han et al., "The effects of acupuncture stimulation at PC6 (Neiguan) on chronic mild stress-induced biochemical and behavioral responses," *Neuroscience Letters*, vol. 460, no. 1, pp. 56–60, 2009.

- [19] L. A. Eckel, H. M. Rivera, and D. P. D. Atchley, "The anorectic effect of fenfluramine is influenced by sex and stage of the estrous cycle in rats," *American Journal of Physiology*, vol. 288, no. 6, pp. R1486–R1491, 2005.
- [20] J.-Y. Guo, C.-Y. Li, Y.-P. Ruan et al., "Chronic treatment with celecoxib reverses chronic unpredictable stress-induced depressive-like behavior via reducing cyclooxygenase-2 expression in rat brain," *European Journal of Pharmacology*, vol. 612, no. 1-3, pp. 54–60, 2009.
- [21] M. Tönissaar, L. Herm, A. Rincken, and J. Harro, "Individual differences in sucrose intake and preference in the rat: circadian variation and association with dopamine D2 receptor function in striatum and nucleus accumbens," *Neuroscience Letters*, vol. 403, no. 1-2, pp. 119–124, 2006.
- [22] L. Prut and C. Belzung, "The open field as a paradigm to measure the effects of drugs on anxiety-like behaviors: a review," *European Journal of Pharmacology*, vol. 463, no. 1–3, pp. 3–33, 2003.
- [23] R.-P. Liu, J.-L. Fang, P.-J. Rong et al., "Effects of electroacupuncture at auricular concha region on the depressive status of unpredictable chronic mild stress rat models," *Evidence-Based Complementary and Alternative Medicine*, vol. 2013, Article ID 789674, 7 pages, 2013.
- [24] P. Gass and M. A. Riva, "CREB, neurogenesis and depression," *BioEssays*, vol. 29, no. 10, pp. 957–961, 2007.
- [25] Y. Dwivedi, H. S. Rizavi, H. Zhang, R. C. Roberts, R. R. Conley, and G. N. Pandey, "Aberrant extracellular signal-regulated kinase (ERK)1/2 signalling in suicide brain: role of ERK kinase 1 (MEK1)," *International Journal of Neuropsychopharmacology*, vol. 12, no. 10, pp. 1337–1354, 2009.
- [26] J. A. Bravo, G. Díaz-Veliz, S. Mora et al., "Desipramine prevents stress-induced changes in depressive-like behavior and hippocampal markers of neuroprotection," *Behavioural Pharmacology*, vol. 20, no. 3, pp. 273–285, 2009.
- [27] C. Pittenger and R. S. Duman, "Stress, depression, and neuroplasticity: a convergence of mechanisms," *Neuropsychopharmacology*, vol. 33, no. 1, pp. 88–109, 2008.
- [28] K. Sakamoto, K. Karelina, and K. Obrietan, "CREB: a multifaceted regulator of neuronal plasticity and protection," *Journal of Neurochemistry*, vol. 116, no. 1, pp. 1–9, 2011.
- [29] W. A. Carlezon Jr., R. S. Duman, and E. J. Nestler, "The many faces of CREB," *Trends in Neurosciences*, vol. 28, no. 8, pp. 436–445, 2005.
- [30] M. D. Houslay and W. Kolch, "Cell-type specific integration of cross-talk between extracellular signal-regulated kinase and cAMP signaling," *Molecular Pharmacology*, vol. 58, no. 4, pp. 659–668, 2000.
- [31] J. A. Blendy, "The Role of CREB in Depression and Antidepressant Treatment," *Biological Psychiatry*, vol. 59, no. 12, pp. 1144–1150, 2006.
- [32] S. L. Gourley, F. J. Wu, D. D. Kiraly et al., "Regionally specific regulation of ERK MAP kinase in a model of antidepressant-sensitive chronic depression," *Biological Psychiatry*, vol. 63, no. 4, pp. 353–359, 2008.
- [33] M. First, I. Gil-Ad, M. Taler, I. Tarasenko, N. Novak, and A. Weizman, "The effects of fluoxetine treatment in a chronic mild stress rat model on depression-related behavior, brain neurotrophins and ERK expression," *Journal of Molecular Neuroscience*, vol. 45, no. 2, pp. 246–255, 2011.
- [34] J. Liang, J. Lu, S. F. Cui, J. R. Wang, and Y. Tu, "Effect of acupuncture on expression of brain-derived neurotrophic factor gene and protein in frontal cortex and hippocampus of depression rats," *Zhen Ci Yan Jiu*, vol. 37, no. 1, pp. 20–24, 2012.
- [35] A. Nair, K. C. Vadodaria, S. B. Banerjee et al., "Stressor-specific regulation of distinct brain-derived neurotrophic factor transcripts and cyclic AMP response element-binding protein expression in the postnatal and adult rat hippocampus," *Neuropsychopharmacology*, vol. 32, no. 7, pp. 1504–1519, 2007.

## Review Article

# Visualization of the Meridian System Based on Biomedical Information about Acupuncture Treatment

**In-Seon Lee, Soon-Ho Lee, Song-Yi Kim, Hyejung Lee, Hi-Joon Park, and Younbyoung Chae**

*Acupuncture and Meridian Science Research Center, College of Korean Medicine, Kyung Hee University, 1 Hoegi-dong, Dongdaemun-gu, Seoul 130-701, Republic of Korea*

Correspondence should be addressed to Younbyoung Chae; [ybchae@khu.ac.kr](mailto:ybchae@khu.ac.kr)

Received 6 March 2013; Revised 29 April 2013; Accepted 12 May 2013

Academic Editor: Wei-bo Zhang

Copyright © 2013 In-Seon Lee et al. This is an open access article distributed under the Creative Commons Attribution License, which permits unrestricted use, distribution, and reproduction in any medium, provided the original work is properly cited.

The origin of the concept of the meridian system is closely connected with the treatment effects of acupuncture, and it serves as an empirical reference system in the clinical setting. Understanding the meridian channels would be a first step in enhancing the clinical efficacy of acupuncture treatment. To understand the relationship between the location of the disease and the sites of relevant acupoints, we investigated acupuncture treatment regimens for low-back pain in 37 clinical studies. We found that the most frequently used acupoints in the treatment of low-back pain were BL23 (51%), BL25 (43%), BL24 (32%), BL40 (32%), BL60 (32%), GB30 (32%), BL26 (28%), BL32 (28%), and GB34 (21%). For the example of low-back pain, we visualized the biomedical information (frequency rates) about acupuncture treatment on the meridians of a three-dimensional (3D) model of the human body. We found that both local and distal acupoints were used to treat low-back pain in clinical trials based on the meridian theory. We suggest a new model for the visualization of a data-driven 3D meridian system of biomedical information about the meridians and acupoints. These findings may be helpful in understanding the meridian system and revealing the effectiveness of acupuncture treatment.

## 1. Introduction

Acupuncture, which originated in East Asia, has been used as a therapeutic intervention for the treatment of various diseases and symptoms for more than 2500 years [1]. Despite cultural, historical, and sociopolitical differences, acupuncture is being used by practitioners in both Western and Eastern nations [2, 3]. Acupuncture treatment is based on a system of meridian channels through which vital energy, or Qi, flows [4]. The meridian system consists of twelve standard meridians, eight extraordinary meridians, and other collaterals. A classical text states, “*The twelve channels link the internal organs internally, and connect with the joints and limbs externally,*” suggesting that the body forms an organic whole by virtue of these internal and external connections and the upward and downward distribution of the meridian channels. A detailed understanding of the meridian system

helps in understanding and contextualizing those connections and in developing a broad sense of acupoints and their actions.

Ancient acupuncture practitioners found therapeutic actions and influences of particular points in relation to particular internal organs, as well as to other parts of the body part far from the point. The observation of points along a certain line sharing similar indications led practitioners to categorize them based on the “lines” on which they were located. The meridian system shows constellations of acupoints that have common therapeutic effects in acupuncture for the specific symptoms of body parts, and it is used to explain the remote effects of acupuncture treatment. For example, the large intestine meridian, also traditionally called the dental meridian, is a line from the index finger to the mouth and nose, and stimulation of points along this line is known to be useful for treating dental pain and facial palsy [5, 6]. The

meridian system has been considered to reflect a systematic body of empirical knowledge that functions as the basis for acupuncture treatment [7]. Understanding the essence of the meridian system helps us in developing an understanding of the interconnections that underlie pathology in a particular disease.

Because the meridian system has a large amount of information regarding the human body surface that is hard to classify by a literal description alone, the ancient people of China invented several methods to display information about acupoints and meridians on the human body surface. Historically, many pictures have been used to describe the meridian system, such as the well-known Mingtang Diagram. The *Illustrated Manual of Points for Acupuncture and Moxibustion on a Bronze Statue with Acupoints* (also called the *Illustrated Classic of Acupuncture Points of the Bronze Model*) and its accompanying bronze statue, developed in the Song Dynasty, defined the first standardized acupoints and constituted the official standardized model of the meridian system [8]. The 3D statue is usually made of bronze and it is still widely used in educational and clinical fields. The Mingtang Diagram and the bronze statue were gradually combined, with descriptions of the relationship between internal organs and the skeletal structure and meridian system [9]. In the West, Ten Rhyne first reported in person East Asian medical practices, including acupuncture, as a medical officer in 1683. He sought to create an interpretative synthesis between Chinese and Western medicine, using the pictures in an attempt at “translation” [10].

Ancient East Asian people intended to explain empirical knowledge using the ancient infographics of the meridian system, but these were limited in reflecting theoretical or abstract meanings [11]. Indeed, the illustrations of the meridian system and acupoints may have made people misunderstand the essential meaning of the meridian system as actual substantial channels. Over the last few decades, many studies have suggested distinctive biophysical features of acupoints and the meridian system, such as high electrical conductance [12–14], nitric oxide levels [9, 15], acupuncture sensation patterns [16], and possible relationships with connective tissue planes [17, 18]. Nevertheless, the scientific evidence on the biophysical existence of acupoints and meridians in humans still needs further explanation. The Bonghan system was originally proposed in the early 1960s by Bonghan Kim and has more recently been replicated by others [19]. However, the conjecture that primovessels (Bonghan ducts) serve the role of meridians in acupuncture has not yet been established. To understand the meridian system properly, we have to start from understanding the origin and clinical significance of the meridian system. The meridian system is a method that proposes connections among different areas, organs, and functions; thus, it is associated with specific patterns of disharmony.

The concept of meridians and acupoints can serve as an empirical reference system in the clinical setting regardless of the anatomical precision of the meridians and acupoints. The traditional Mingtang Diagram and bronze statue only depict information about the locations of acupoints and

the meridians. When we want to know which acupoint(s) would be useful in treating a certain disease, we cannot find answers from these illustrations and/or this statue. Here, we suggest a new model of the meridian system that incorporates clinical data with the meridian map, an infographic expressing biomedical information about the meridian system and acupoints.

## 2. Methods

**2.1. Selection of Biomedical Information.** In the current study, we consider the example of acupuncture treatment regimens for low-back pain and visualize the meridian system in terms of biomedical information about acupuncture treatments. To determine which acupoints are useful in treating low-back pain, we extracted acupuncture-point-related information from clinical acupuncture treatment trials for low-back pain.

**2.2. Selection of Studies.** We searched Medline, five Korean databases, relevant journals, and trial registries for randomized, controlled trials of acupuncture that involved needling for low-back pain. Reference lists of all the papers located and relevant reviews were checked for missing articles. Search terms used for Medline were as follows: (((acupuncture [Title/Abstract] AND low-back pain [Title/Abstract]) OR (acupuncture [Title/Abstract] AND lumbago [Title/Abstract])) OR (acupuncture [Title/Abstract] AND lumbar pain [Title/Abstract])) OR (acupuncture [Title/Abstract] AND lower back pain [Title/Abstract]), with slight modifications for individual searches in each database, over the time period from January 1980 to April 2012.

We included randomized controlled trials, clinical controlled trials, and case reports/series that used needle-type acupuncture (manual acupuncture, electronic acupuncture) to treat low-back pain written in English or Korean. To find general acupuncture treatment regimens for low-back pain, we investigated the frequency of the acupoints selected in each study among the trials. We reanalyzed data from previous published study [20] using data-based meridian map technique, designed to both estimate the magnitude of the resulting frequency values and provide interpretable maps of which acupoints are useful to treat low-back pain. Detailed information was provided in our previous systematic review on the selection of acupoints for low-back pain [20].

**2.3. Visualization of the Meridian Map.** The algorithm aims to identify acupoints that are related to a convergence of use across a series of studies. The frequency of acupoint use (%) was calculated as the number of studies using a certain acupoint in each study divided by the total number of studies  $\times$  100. The meridian systems were overlaid on the “3D Meridian map” anatomical template using Autodesk 3ds Max Design 2009 software. The basic anatomical template was TurboSquid’s 3D human male body (<http://www.turbosquid.com>). The acupoints data were labeled according to the magnitude of the resulting frequency values.

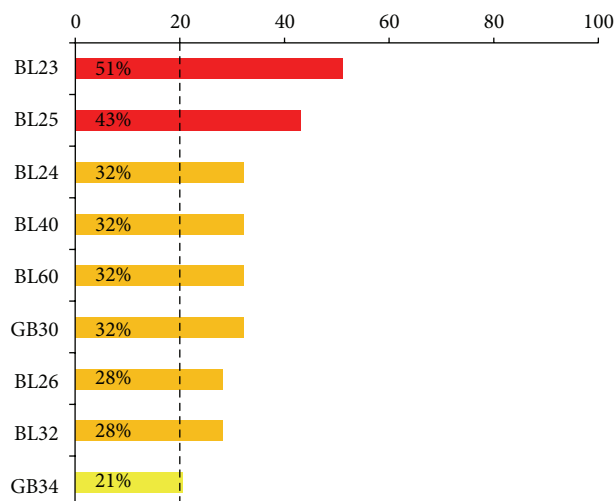

FIGURE 1: Frequency of acupoints in 53 studies. Frequency of acupoints selected in each study (%). Frequency % = number of studies using certain acupoint/total number of studies  $\times$  100. The most frequently adopted acupoints for the treatment of the low-back pain (used in >20% of the studies) were BL23 (51%), BL25 (43%), BL24 (32%), BL40 (32%), BL60 (32%), GB30 (32%), BL26 (28%), BL32 (28%), and GB34 (21%).

### 3. Results

#### 3.1. Most Frequently Used Acupoints for Low-Back Pain.

Through this systematic review, we found 37 articles (17 Korean, 20 international) and 53 studies (28 Korean, 25 international). The most frequently used acupoints for the treatment of the low-back pain (used in over 20% of the 53 studies) were BL23 (51%), BL25 (43%), BL24 (32%), BL40 (32%), BL60 (32%), GB30 (32%), BL26 (28%), BL32 (28%), and GB34 (21%) (Figure 1).

#### 3.2. Visualization of Data-Driven 3D Meridian System for Low-Back Pain.

We demonstrated a data-driven 3D meridian system for low-back pain based on frequency analysis of the results of a systematic review of the relevant literature. Figure 2(b) shows these acupoints according to frequency of use (>20% of the studies) for low-back pain treatment. The acupoints include seven acupoints (BL23, BL24, BL25, BL26, and BL32 as local points and BL40 and BL60 as distal points) on the *bladder meridian* and two acupoints (GB30 as a local point and GB34 as a distal point) on the *gallbladder meridian*.

### 4. Discussion

Using the example of low-back pain, we suggest a new model of the meridian system based on biomedical information about the meridians and acupoints. In the current study, we found that the most frequently used acupoints for the treatment of low-back pain in 53 clinical studies were BL23 (51%), BL25 (43%), BL24 (32%), BL40 (32%), BL60 (32%), GB30 (32%), BL26 (28%), BL32 (28%), and GB34 (21%; Figure 1). The traditional Mingtang Diagram was regarded as

explaining empirical knowledge using the ancient infographics of the meridian system; for example, it indicated that some acupoints on the lower limb could exert remote control of the posterior part of the body, such as the back, neck and head (i.e., the bladder meridian; Figure 2(a)). However, these illustrations do not deal with biomedical information based on clinical data; instead, they express theoretical or abstract meanings of the meridian system. Here, we propose that the acupoints can be depicted according to the frequency of their use in the treatment of low-back pain based on a comprehensive set of quantitative clinical data (Figure 2(b)). This should be helpful in understanding the essential meaning of the meridian system and in providing clinical guideline, evaluating the results of clinical trials appropriately and assessing the effectiveness of the acupoints used. Data-based meridian map techniques estimate the magnitude of the resulting frequency values and provide interpretable maps of which acupoints are useful to treat low-back pain.

The current study showed which acupoints were generally used in treating low-back pain based on 53 treatment regimens in clinical trials. The analysis of these regimes showed that the bladder meridian (BL23, BL24, BL25, BL26, BL32, BL40, and BL60) and the gall bladder meridian (GB30, GB40) were most frequently used in treating low-back pain. These findings were considerably consistent with the traditional Chinese medicine theory, in which some acupoints, including BL23, BL25, GV3, BL40, GB30, are commonly used in the treatment of chronic low-back pain [21]. As the symptoms of low-back pain were frequently located in the low-back area, the characteristics of the bladder meridian would suggest prominent connections between the disease area and the foci of acupoints. Both local (BL23, BL24, BL25, BL26, and BL32) and distal (BL40, BL60) acupoints based on meridian theory were used to treat low-back pain in these clinical trials. The observation that points along the posterior line in the low back and the posterior line in the lower limb share similar indications could be explained in terms of the bladder meridian on which they are located. Biomedical information about the meridian system could explain how the concepts of the meridians and acupoints served as an empirical reference system in the clinical setting.

In a German study, after standardized acupuncture (plus some additional points) for 6 months, the response rate was 47.6% in the real acupuncture group, 44.2% in the sham acupuncture group, and 27.4% in the conventional therapy group [22]. A meta-analysis in 2008, which involved 23 trials ( $n = 6359$ ), demonstrated that acupuncture was more effective than no treatment but that real acupuncture treatments were not more effective than sham acupuncture treatment [23]. However, because extensive clinical trials have suggested that acupuncture may be more effective than usual care, it may best be understood as a useful supplement to other forms of conventional therapy for nonspecific low-back pain [21]. Treatment regimens of acupuncture for low-back pain can differ according to the type of reference source, treatment frequency, the points chosen, the number of points needed per session, the duration and number of sessions, and cointerventions [24]. Because the selection of acupoints

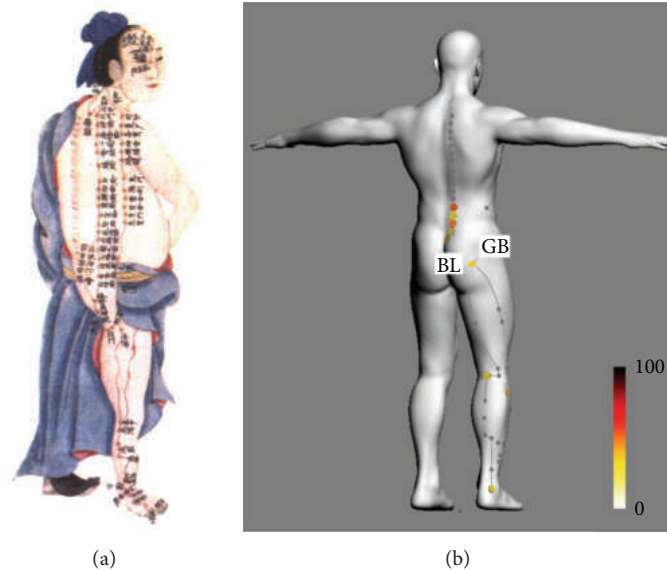

FIGURE 2: (a) A traditional Mingtang Diagram for the bladder meridian from the Qing Dynasty. (b) A new model of a data-driven 3D visualization of the meridian system based on biomedical information on the meridians and acupoints for low-back pain. Acupoints are marked according to the frequency of their use in the treatment of low-back pain as reported in the clinical data.

is highly associated with the outcome of acupuncture treatment, it is important to evaluate the role of each acupoint in clinical trials. As most of clinical trials only provide the overall clinical efficacy of acupuncture treatment and do not deal with issues related to acupoint, it would be very difficult to determine which acupoints were most useful in treating low-back pain from reports of the previous clinical trials.

The present study visualized biomedical information (frequency-based information) on the meridians of 3D surface anatomical models of the human body for low-back pain. These tools could be extended to other kinds of diseases with more meaningful biomedical information (efficacy-based information and/or bibliographical information). The computer modeling of biological systems has been considered an important technique for organizing and integrating vast amounts of biological information [25]. Systems biology has been developed to achieve the goal of understanding the interactions in complex pathways of multiple components and between multiple levels of function using mathematics and computing [26]. In the near future, these computational approaches to the meridian system will become more integrated and will be more readily linked with bioinformatic databases from clinical trials and/or classical texts. At that point, it will be possible to gather a better-organized data-based 3D visualized meridian system containing the therapeutic effects of acupuncture. Collection of further meaningful biomedical information on acupuncture with a multiscale modeling framework in a variety of diseases is still needed.

In sum, we suggest a new model for the visualization of a data-driven 3D meridian system, “*The Meridian Map*,” which expresses available biomedical information on the meridian system and acupoints using infographic means. The significance of the meridian system is not based simply on

the twelve lines of the whole organism but also relies on the logic of the interconnections between particular diseases and acupuncture sites. Understanding the essence of the meridian channels enables people to grasp the principles of the selection of acupoints and to enhance the clinical efficacy of acupuncture treatment in various diseases.

## Acknowledgments

This research was supported by the Basic Science Research Program through the National Research Foundation of Korea (NRF), funded by the Ministry of Education, Science and Technology (No. 2005-0049404 & No. 2011-0009913).

## References

- [1] J. Jia, Y. Yu, J. H. Deng et al., “A review of Omics research in acupuncture: the relevance and future prospects for understanding the nature of meridians and acupoints,” *Journal of Ethnopharmacology*, vol. 140, no. 3, pp. 594–603, 2012.
- [2] N. Robinson, A. Lorenc, W. Ding et al., “Exploring practice characteristics and research priorities of practitioners of traditional acupuncture in China and the EU-A survey,” *Journal of Ethnopharmacology*, vol. 140, no. 3, pp. 604–613, 2012.
- [3] G. A. Ulett, J. Han, and S. Han, “Traditional and evidence-based acupuncture: history, mechanisms, and present status,” *Southern Medical Journal*, vol. 91, no. 12, pp. 1115–1120, 1998.
- [4] J. C. Longhurst, “Defining meridians: a modern basis of understanding,” *Journal of Acupuncture and Meridian Studies*, vol. 3, no. 2, pp. 67–74, 2010.
- [5] E. Ernst and M. H. Pittler, “The effectiveness of acupuncture in treating acute dental pain: a systematic review,” *British Dental Journal*, vol. 184, no. 9, pp. 443–447, 1998.
- [6] W. Wang, L. Liu, X. Zhi et al., “Study on the regulatory effect of electro-acupuncture on Hegu point (LI4) in cerebral response

- with functional magnetic resonance imaging,” *Chinese Journal of Integrative Medicine*, vol. 13, no. 1, pp. 10–16, 2007.
- [7] C. S. Yin and H. G. Koh, “What’s the original concept of meridian and acupuncture point in oriental medicine?—a perspective of medical history,” *Uisahak*, vol. 14, no. 2, pp. 137–150, 2005.
- [8] W. H. Liu, “Thinking about standard and standardization of acupuncture and moxibustion,” *Zhongguo Zhen Jiu*, vol. 29, no. 1, pp. 40–43, 2009.
- [9] Y. Ha, M. Kim, J. Nah, M. Suh, and Y. Lee, “Measurements of location-dependent nitric oxide levels on skin surface in relation to acupuncture point,” *Evidence-Based Complementary and Alternative Medicine*, vol. 2012, Article ID 781460, 7 pages, 2012.
- [10] R. Bivins, “The needle and the lancet: acupuncture in Britain, 1683–2000,” *Acupuncture in Medicine*, vol. 19, no. 1, pp. 2–14, 2001.
- [11] L. X. Huang, *The Historical Development of Acupuncture*, Huaxia Publishing House, Beijing, China, 2001.
- [12] A. C. Ahn, A. P. Colbert, B. J. Anderson et al., “Electrical properties of acupuncture points and meridians: a systematic review,” *Bioelectromagnetics*, vol. 29, no. 4, pp. 245–256, 2008.
- [13] A. C. Ahn, M. Park, J. R. Shaw, C. A. McManus, T. J. Kaptchuk, and H. M. Langevin, “Electrical impedance of acupuncture meridians: the relevance of subcutaneous collagenous bands,” *PLoS ONE*, vol. 5, no. 7, Article ID e11907, 2010.
- [14] B. J. Gow, J. L. Cheng, I. D. Baikie et al., “Electrical potential of acupuncture points: use of a noncontact scanning Kelvin probe,” *Evidence-Based Complementary and Alternative Medicine*, vol. 2012, Article ID 632838, 8 pages, 2012.
- [15] S. X. Ma, X. Y. Li, T. Sakurai, and M. Pandjaitan, “Evidence of enhanced non-enzymatic generation of nitric oxide on the skin surface of acupuncture points: an innovative approach in humans,” *Nitric Oxide*, vol. 17, no. 2, pp. 60–68, 2007.
- [16] F. Beissner and I. Marzolf, “Investigation of acupuncture sensation patterns under sensory deprivation using a geographic information system,” *Evidence-Based Complementary and Alternative Medicine*, vol. 2012, Article ID 591304, 10 pages, 2012.
- [17] H. M. Langevin, D. L. Churchill, J. Wu et al., “Evidence of connective tissue involvement in acupuncture,” *The FASEB Journal*, vol. 16, no. 8, pp. 872–874, 2002.
- [18] H. M. Langevin and J. A. Yandow, “Relationship of acupuncture points and meridians to connective tissue planes,” *Anatomical Record*, vol. 269, no. 6, pp. 257–265, 2002.
- [19] K. S. Soh, “Bonghan circulatory system as an extension of acupuncture meridians,” *Journal of Acupuncture and Meridian Studies*, vol. 2, no. 2, pp. 93–106, 2009.
- [20] I. S. Lee, H. J. Jo, S. H. Lee et al., “Systematic review of selection of acupuncture points for lower back pain,” *Korean Journal of Acupuncture*, vol. 29, no. 4, pp. 519–536, 2012.
- [21] B. M. Berman, H. M. Langevin, C. M. Witt, and R. Dubner, “Acupuncture for chronic low back pain,” *The New England Journal of Medicine*, vol. 363, no. 5, pp. 454–461, 2010.
- [22] M. Haake, H. H. Müller, C. Schade-Brittinger et al., “German Acupuncture Trials (GERAC) for chronic low back pain: randomized, multicenter, blinded, parallel-group trial with 3 groups,” *Archives of Internal Medicine*, vol. 167, no. 17, pp. 1892–1898, 2007.
- [23] J. Yuan, N. Purepong, D. P. Kerr et al., “Effectiveness of acupuncture for low back pain: a systematic review,” *Spine*, vol. 33, no. 23, pp. E887–E900, 2008.
- [24] J. Yuan, D. Kerr, J. Park, X. H. Liu, and S. McDonough, “Treatment regimens of acupuncture for low back pain—a systematic review,” *Complementary Therapies in Medicine*, vol. 16, no. 5, pp. 295–304, 2008.
- [25] D. Noble, “Modeling the heart—from genes to cells to the whole organ,” *Science*, vol. 295, no. 5560, pp. 1678–1682, 2002.
- [26] E. J. Crampin, M. Halstead, P. Hunter et al., “Computational physiology and the physiome project,” *Experimental Physiology*, vol. 89, no. 1, pp. 1–26, 2004.

## Research Article

# Simple Acupoints Prescription Flow Chart Based on Meridian Theory: A Retrospective Study in 102 Dogs

Jong-Ho Jeong,<sup>1</sup> Joo-Young Song,<sup>2</sup> Hyo-Gwon Jo,<sup>3</sup> Ji-Min Kim,<sup>4</sup>  
Samuel-S. Yoon,<sup>5</sup> Chul Park,<sup>6</sup> Seunghyun Kim,<sup>7</sup> Seong-Soo Roh,<sup>7</sup> Bong Hyo Lee,<sup>7</sup>  
Chae Ha Yang,<sup>7</sup> and Hee Young Kim<sup>8</sup>

<sup>1</sup> Boo-Young Animal Hospital, Gigeum-dong, Namyangju-si, Gyeonggi-do 472-080, Republic of Korea

<sup>2</sup> Sarang Animal Hospital, Guro-3-dong, Gurogu, Seoul 152-053, Republic of Korea

<sup>3</sup> Jakjeon 24 Hour Animal Hospital, Jakjeon 1-dong, Gyeyang-gu, Incheonsi, Gyeonggi-do 407-060, Republic of Korea

<sup>4</sup> Jun Animal Hospital, Galsan-dong, Dongangu, Anyangsi, Gyeonggi-do 431-088, Republic of Korea

<sup>5</sup> Twin City Animal Hospital, 869 South Street, Fitchburg, MA 01420, USA

<sup>6</sup> Department of Veterinary Internal Medicine, College of Veterinary Medicine, Chonbuk National University, Jeonju-si, Jeollabuk-do 561-756, Republic of Korea

<sup>7</sup> College of Korean Medicine, Daegu Haany University, Daegu 706-828, Republic of Korea

<sup>8</sup> Department of Physiology, College of Korean Medicine, Daegu Haany University, Daegu 706-828, Republic of Korea

Correspondence should be addressed to Hee Young Kim; [hykim@dhu.ac.kr](mailto:hykim@dhu.ac.kr)

Received 8 February 2013; Accepted 9 April 2013

Academic Editor: Younbyoung Chae

Copyright © 2013 Jong-Ho Jeong et al. This is an open access article distributed under the Creative Commons Attribution License, which permits unrestricted use, distribution, and reproduction in any medium, provided the original work is properly cited.

To help the clinicians prescribe acupoints easily and effectively, we developed one simple flow chart to select acupoints. This study aimed to evaluate the usefulness of flow chart to select acupoints in dogs. Total 102 dogs showing intervertebral disc disease (IVDD) ( $n = 12$ ), vomiting ( $n = 11$ ), diarrhea ( $n = 2$ ), abdominal pain ( $n = 5$ ), cough ( $n = 66$ ), or epilepsy ( $n = 6$ ) received acupuncture treatment according to the chart, and its outcomes were evaluated as regards clinical symptoms, duration, treatment numbers, and recovery time. Dogs (8/8) with IVDD from grades I to III recovered over periods of 5 days to 6 weeks after 1–12 treatments, while 1/4 dogs with grade IV recovered over 7 weeks after 15 treatments. Vomiting dogs with acute/subacute ( $n = 8$ ) and chronic symptoms ( $n = 3$ ) required about 1 and 7 treatments to recover fully, respectively. All dogs ( $n = 5$ ) with abdominal pain showed fast relief within 24 hours after acupuncture. Two diarrhea cases recovered over 2–9 days after 1–2 treatments. Fifty-four of 66 coughing dogs were recovered by 1–2 treatments. And 5 of 6 epilepsy dogs under a regular acupuncture treatment had no epileptic episode during followup of 12 months. These results suggest that this flow chart can help the clinicians prescribe acupoints effectively.

## 1. Introduction

Acupuncture had been used in human and veterinary practice for thousands years in Eastern Asia including China (called traditional Chinese medicine), Republic of Korea (called Korean medicine), Japan (called Kampo medicine), and other Asian countries until it was banned in their countries to promote Western medicine in the early 1900s. Since the visit of President Nixon to China in 1972 and articles about surgery in conscious patients under acupuncture anesthesia first hit the West, there has been an explosion of

interest about acupuncture in the United States, Europe, and other countries. Veterinary acupuncture has also been resurrected and developed rapidly during the past 30 years. Veterinary acupuncture organizations have been established in most developed countries including those of North and South America, Europe, the Middle East, Australia and New Zealand, South Africa, Republic of Korea, and many Asian countries. Also, some veterinary schools have included class on acupuncture in their curriculum [1].

The number of certified veterinary acupuncturists and veterinarians wishing to study acupuncture has increased



remarkably in the last decade. Now, many veterinarians and veterinary students spend much effort and expense to learn traditional oriental medical (OM) theory in an intensive course. They aim at integrating acupuncture into their practice but they discover quickly that OM theories are extremely complex and confusing to be applied in practice. Therefore, novices in the art science of veterinary acupuncture tend to rely strongly on “Cookbook Acupuncture,” in which a routine set of acupoints is used to treat certain diseases. Though “Cookbook Acupuncture” is very useful for beginners, it is not specific for individual cases and its results are not as good as those of acupuncture adapted by experts for each specific case. Therefore, many practitioners using “Cookbook Acupuncture” become frustrated when they achieve outstanding results in some cases but no response in others.

To apply acupuncture most effectively, practitioners must make an OM diagnosis for each case, by using OM theory. That theory includes *Yin-Yang*, *Zang-Fu* organs, Channel (Meridian) Theory, and point indications. According to the OM diagnosis, two sets of acupoints are chosen: (a) main (essential) points and (b) helper (supporting) points. This combination of main and helper points is called an acupoints prescription or combination for each individual case. The correct choice of points plays a key role in acupuncture's success. When appropriated on combination, the main and helper acupoints produce synergic effects that boost the clinical efficacy of acupuncture. In contrast, some acupoints may counter the beneficial effects of the main acupoints through opposing actions [2–4]. For clinicians to select effective acupoints for individual cases efficiently, it is essential that they understand OM diagnosis, the properties and interactions of the Channels, the functions of each acupoint, and combination methods of their acupoints. However, it is difficult, especially for new acupuncturists, to comprehend OM theories completely, memorize all the information about acupoints, and build each treatment plan according to individual patient's condition. Therefore, we sought to develop for clinicians one simple acupuncture flow chart based on OM theories and diagnosis. Over a 5-year period, this flow chart has been modified through its clinical application. We now introduce one simple acupoints prescription chart and its clinical cases.

## 2. Materials and Methods

**2.1. Acupoints Prescription Chart (Figure 1).** The proposed chart was designed to select acupoints in a total of 5 steps.

In Step 1, according to the location of disease in the body (viz interior or exterior), two or three acupuncture points of 8 Extraordinary Channel points and 6 Command points were selected (Figures 2(a) and 2(b)).

In Step 2, one of 8 Influential points was chosen according to the body components (*Zang, Fu, Muscle, Bone, Qi, Blood, Vessel, and Marrow*) affected by disease (Figure 3).

In Step 3, the *Back-Shu* or *Abdomen-Mu* points sensitive to palpation were selected. To find the sensitive *Shu* (Figure 4(a)) or *Mu* (Figure 4(b)) points on back and abdomen, the right hand palpated the skin on *Back-Shu* and *Abdomen-Mu* points while the left hand was positioned

on abdomen. The points at which dogs exhibited the protective abdominal reflex, skin twisting, growling, grunting, and head-turning toward the palpated point during palpation were considered as sensitive *Back-Shu* or *Abdomen-Mu* points, which were diagnosed as the affected internal organs [5] for the next Step 4. Those points were used as treatment points.

In Step 4, according to the diagnostic results from Step 3 or patients' main symptoms, the associated Channels were chosen (Figures 5(a) and 5(b)), and two main points, *Yuan* (source) point and *He* (sea) point, on the Channels were used for acupuncture. Some points on the Channel frequently were chosen according to the patient's condition, such as acute/subacute (<7 days), chronic (>7 days), emergency, or joint pain.

Lastly, in Step 5, local points or empirical points for each case were added.

**2.2. Cases ( $n = 102$ ).** The 102 dogs that received acupuncture treatment by 5 clinicians according to simple acupuncture flow chart were reviewed. Table 1 shows case signalment including age, sex, and disease duration. Ages of dogs varied from 3 months to 15 years (average age, 4.12 years). Forty-six percent (47/102) were males, and 54% (55/102) were females. Purebred dogs accounted for 52% (53/102) and were represented by 9 pure breeds (11 miniature Poodles, 14 Maltese, 6 Shih Tzus, 2 Chihuahuas, 1 Siberian husky, 8 Yorkshire terriers, 2 English cockers, 5 Pugs, and 4 miniature Schnauzers). The remaining 48% (49/102) were mixed-breed dogs. Routine diagnostic tests including fecal examination, urinalysis, blood tests, and/or radiography were performed in private practice to determine the possible cause.

Acupuncture was prohibited in cases with evidence of foreign body on radiography or infectious viral disease (distemper or parvovirus) by commercial ELISA kits. All except epilepsy cases received acupuncture treatment only without conventional Western medicine. Cases were classified into 6 groups, according to main symptoms: intervertebral disc disease (IVDD) ( $n = 12$ ), vomiting ( $n = 11$ ), diarrhea ( $n = 2$ ), abdominal pain ( $n = 5$ ), cough ( $n = 66$ ), and epilepsy ( $n = 6$ ) (Table 1). IVDD was further classified as grade I to IV: grade I = no neurologic signs except back pain, grade II = conscious proprioceptive deficit and ambulatory paraparesis, grade III = nonambulatory paraparesis, and grade IV = nonambulatory paraparesis with loss of deep pain perception [6]. Gastrointestinal disorders including vomiting, diarrhea, and abdominal pain were classified by the duration to clinical presentation as acute (<2 days), subacute (2–7 days), or chronic (>7 days). Application of acupuncture for cough was restricted to subacute cases (duration, 2–7 days), since acute cough was often a self-limiting problem that may resolve without any symptomatic/supportive therapy, or chronic cases had a risk of severe bacterial infection without antibiotics, subsequently death. In idiopathic epilepsy, one dog was 3 months at onset of epileptic seizure and the remaining 5 dogs were over 1 year, at a frequency of 2–4/month under control of phenobarbital and potassium bromide therapy. Five of the 6 dogs showed generalized and symmetrical seizure and

STEP 1: Find the location of disease [combined therapy of 8 extraordinary channel points and 6 command points]

Location of disease		Points	Add command points
Exterior	Dorsal aspects	SI3-BL62	-add ST36 for gastrointestinal disorders, -add SP6 for urogenital disorders -add BL40 for back disorders -add LI4 for face, eye, nasal disorders
	Lateral aspects	TH5-GB41	
Interior	Heart and gastrointestinal	PC6-SP4	
	Respiratory and urological	LU7-KI6	

STEP 2: Find the affected area [8 influential points therapy]

The affected area	Point	OM name
Liver, heart (pericardium), spleen (pancreas), lung, kidney	LV13	Zang (Yin organs)
Stomach, small intestine, large intestine, bladder	CV12	Fu (Yang organs)
Muscle-related diseases	GB34	Ji (muscle)
Bone-related diseases, especially in forelimb	BL11	Gu (bone)
Thoracic disease (mainly, respiratory)	CV17	Qi (life/vital energy)
Blood-related disorders	BL17	Xue (blood)
Vascular or circulatory disorders	LU9	Mai (vessels)
Neurological diseases, bone marrow disorders, fracture	GB39	Sui (marrow)

STEP 3: Find sensitive back-Shu or abdomen-Mu points when palpated [Shu-Mu points therapy]

Point	Lung (LU)	Heart (HT)	Pericardium (PC)	Spleen (SP)	Kidney (KI)	Liver (LV)	Large intestine (LI)	Small intestine (SI)	Triple heater	Stomach (ST)	Bladder (BL)	Gall bladder (GB)
Back-Shu point	BL13	BL15	BL14	BL20	BL23	BL18	BL25	BL27	BL22	BL21	BL28	BL19
Abdomen-Mu point	LU1	CV14	CV17	LV13	GB25	LV14	ST25	CV4	CV5	CV12	CV3	GB24

Step 4: choose the channel and main points on the channel according to main symptoms [channel points therapy]

Location of symptoms		Interior						Exterior					
		Pancreas	Respiratory	Liver	Cardio-vascular	Urogenital (interior)	Mental	Front aspects		Lateral aspects		Posterior aspects	
Gastro-intestinal	Muscle, tendon	Gastro-intestinal		Face				Ear	Ear	Thoraco-lumbar spine	Scapula		
Blood	Urogenital (exterior)											Bone marrow	Tooth
Point indication	Channel OM name	Hindlimb TaiYin	Forelimb TaiYin	Hindlimb JueYin	Forelimb JueYin	Hindlimb ShaoYin	Forelimb ShaoYin	Hindlimb YangMing	Forelimb Yangming	Hindlimb ShaoYang	Forelimb ShaoYang	Hindlimb TaiYang	Forelimb TaiYang
	Organ Point	SP	LU	LV	PC	KI	HT	ST	LI	GB	TH	BL	SI
Main (essential)	Yuan (source)	SP3	LU9	LV3	PC7	KI3	HT7	ST42	LI4	GB40	TH4	BL64	SI4
	He (sea)	SP9	LU5	LV8	PC3	KI10	HT3	ST36	LI11	GB34	TH10	BL40	SI8
Acute	Xi (cleft)	SP8	LU6	LV6	PC4	KI5	HT6	ST34	LI7	GB36	TH7	BL63	SI6
Chronic	Luo (connection)	ST40	LI6	GB37	TH5	BL58	SI7	SP4	LU7	LR5	PC6	KI4	HT5
Emergency	Jing (well)	SP1	LU11	LV1	PC9	KI1	HT9	ST45	LI1	GB44	TH1	BL67	SI1
Heat signs	Ying (spring)	SP2	LU10	LV2	PC8	KI2	HT8	ST44	LI2	GB43	TH2	BL66	SI2
Joint pain	Shu (stream)	SP3	LU9	LV3	PC7	KI3	HT7	ST43	LI3	GB41	TH3	BL65	SI3
Cold signs	Jing (river)	SP5	LU8	LV4	PC5	KI7	HT4	ST41	LI5	GB38	TH6	BL60	SI5

STEP 5: Empirical, local or Ashi points

Emergency	Tonification effect	Fever	Head	Neck	Eye	Lower jaw	Cough	Humeral joint	Lumbar & sacral	Diarrhea
GV26, KI1, HT9, PC9	LI4, LI11, LV3, ST36	ear tip, tail tip, GV14	GV20, GB20, GV16, Yintang	GB20, BL10, GV16	ST1, L1, GB1	ST7	CV22	LI15, TH14	Baihui	GV1

FIGURE 1: Acupoints prescription flow chart.

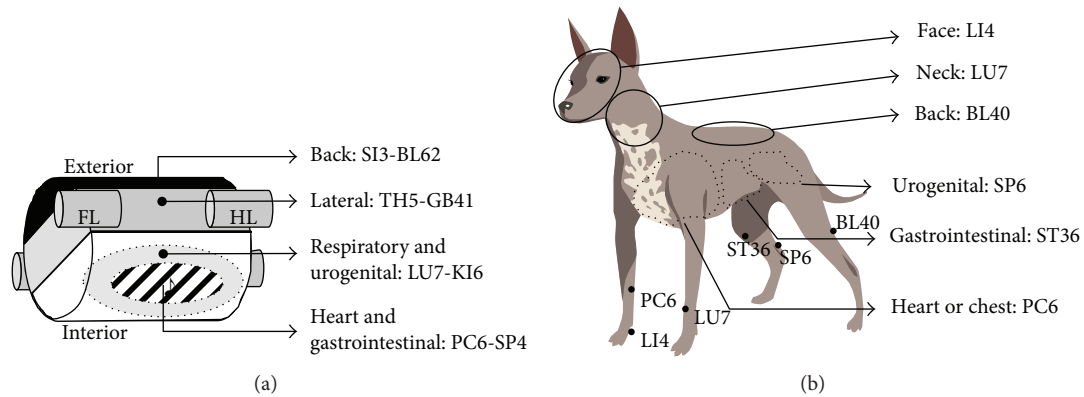

FIGURE 2: 8 Extraordinary Channel points and 6 Command points (Step 1). (a) Clinical indications of 8 Extraordinary Channel points. The body was simply divided into 4 areas of exterior-back aspects, exterior-lateral aspects, interior-heart/gastrointestinal and interior-respiratory/urogenital systems, and paired acupoints (underlined) were used for disorders of their corresponding area. (b) Indication of 6 Command points. FL, forelimb; HL, hind limb.

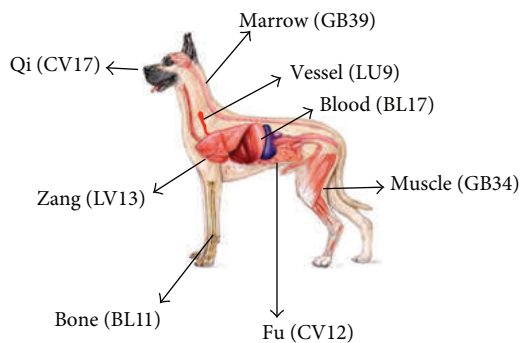

FIGURE 3: 8 Influential points (Step 2). Based on OM, body consists of 8 components and each of them can be controlled by its key point (underlined).

one was seen to have unilateral focal motor activity of the head which spread to unilateral limbs.

**2.3. Acupuncture Treatment.** Acupuncture was performed by 5 veterinarians in their own practice. After selecting acupoints according to the flow chart (Figure 1), acupuncture needles (stainless steel, 0.24–0.30 mm in diameter, 15–40 mm in length) were inserted, as described in text [5] and left for 15–20 minutes with/without manipulation. Acupuncture was applied 2–3 times/week. Clinical followup was determined either by a phone call to the owners at the time of this study or by return of the dog to the veterinary hospital. Treatment was discontinued if the owner stated the symptoms had ceased and if main symptoms were apparently disappeared on laboratory or physical examination.

### 3. Results

**3.1. IVDD ( $n=12$ ).** The age of the dogs varied from 2 to 9 years with an average age of 3.6 years. The affected breeds were miniature Poodle ( $n=3$ ), Yorkshire terrier ( $n=2$ ),

miniature Schnauzer ( $n=2$ ), Shih Tzu ( $n=1$ ), and mixed-breed ( $n=4$ ). Spinal palpation pain (hyperesthesia), when assessed by manual compression along the thoracolumbar spine, was detected at one or more levels of T11–T12 ( $n=2$ ), T12–T13 ( $n=6$ ), T13–L1 ( $n=5$ ), L1–L2 ( $n=4$ ), L2–L3 ( $n=1$ ), and L3–L4 ( $n=1$ ). In cases with severe symptoms (grade III or IV), diffuse back pain over two spinal levels was frequently observed. On plain radiographic examination, narrowed intervertebral disk space ( $n=3$ ), osteophyte formation ( $n=1$ ), or mineralized intervertebral disk ( $n=2$ ) was found in grade III or IV cases. According to the flow chart (Figure 1), the following points were chosen for acupuncture: SI3, BL62, and BL40 (in Step 1), GB34 (in Step 2), Back-*Shu* points at levels showing hyperesthesia on the spinal palpation (in Step 3), and BL40 and BL60 (in Step 4). Acupuncture was performed 2–3 times a week. Cases that returned to normal or cases with non-ambulatory paraparesis (grade III or IV) that improved to be able to walk and void urine and feces without assistance were considered to be recovered. All dogs (8/8, 100%) from grades I to III recovered over periods of 5 days to 6 weeks after 1–12 treatments, while only 1/4 dogs (25%), diagnosed as grade IV, recovered over 7 weeks after 15 treatments.

**3.2. Vomiting ( $n=11$ ).** The vomiting cases, diagnosed as unknown causes from diagnostic tests or not responsive to initial managements of food withdrawals and antiemetics for 1–3 days, were subjected to this acupuncture treatment. They were young ( $n=1$ , 6 months) or young adult dogs ( $n=10$ , average age = 3.2 yrs) and showed commonly vomiting and inappetance. The acupoints were chosen based on the flow chart: PC6, SP4, and ST36 (in Step 1), LV13 and CV12 (in Step 2), sensitive Back-*Shu*, and Abdomen-*Mu* points to palpations (in Step 3), ST36, ST42, SP3, and SP9 (in Step 4). Acute vomiting cases (<2 days;  $n=6$ ) were well responsive to this acupuncture treatment. Interestingly, 3 of them began to eat food within 1 hr after withdrawals of acupuncture needles and did not show any vomiting. In subacute cases (2–7 days;  $n=2$ ) that showed vomiting 3–5 times/day and were

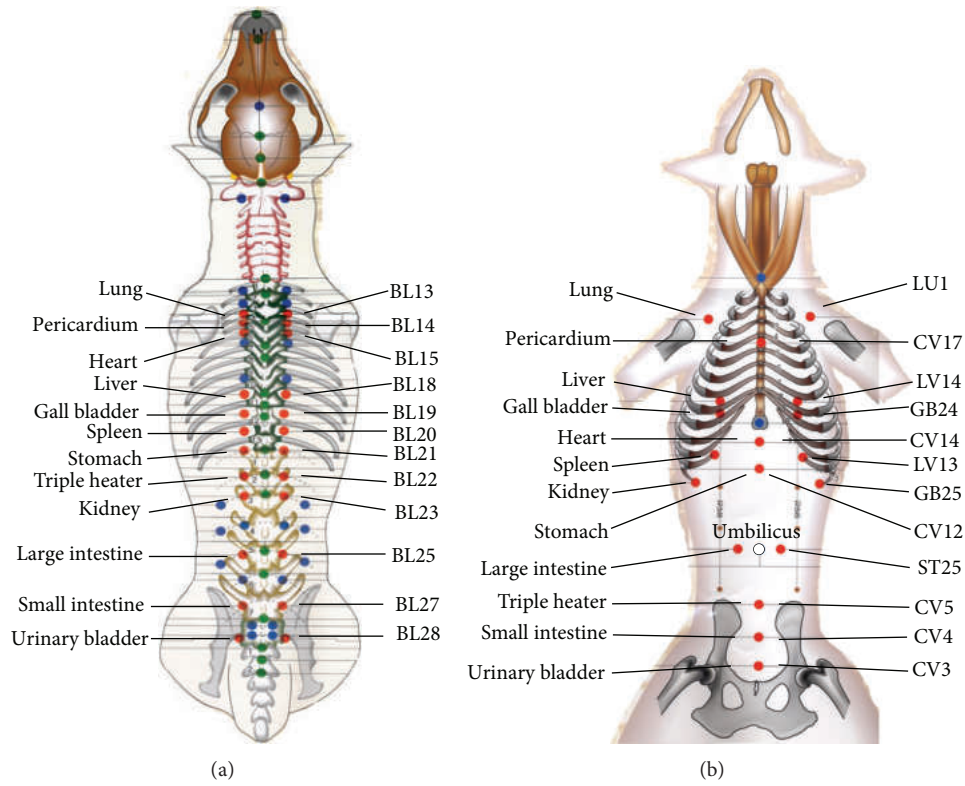

FIGURE 4: Back-Shu and Abdomen-Mu points (Step 3). (a) Back-Shu points (red color points) and internal organs. (b) Abdomen-Mu points (red color points) and internal organs.

TABLE 1: Case signalment.

Diseases	Severity	Duration	Case ( <i>n</i> )	Sex		Age (year)
				Male	Female	
IVDD	Grade I		1	1		3.00
	Grade II		1	1		2.00
	Grade III		6	2	4	2.87
	Grade IV		4	2	2	5.25
Vomiting	Acute	<2 days	6	2	4	2.77
	Subacute	2-7 days	2		2	3.50
	Chronic	>7 days	3	3		3.00
Diarrhea	Acute	<2 days	1		1	1.50
	Subacute	2-7 days	1	1		0.60
	Chronic	>7 days				
Abdominal pain	Acute	<2 days	5	2	3	2.54
	Subacute	2-7 days				
	Chronic	>7 days				
Cough	Acute	<2 days				
	Subacute	2-7 days	66	30	36	4.55
	Chronic	>7 days				
Epilepsy		<1 year	1	1		0.6
		>1 year	5	2	3	5.76
Total			102	47	55	3.75

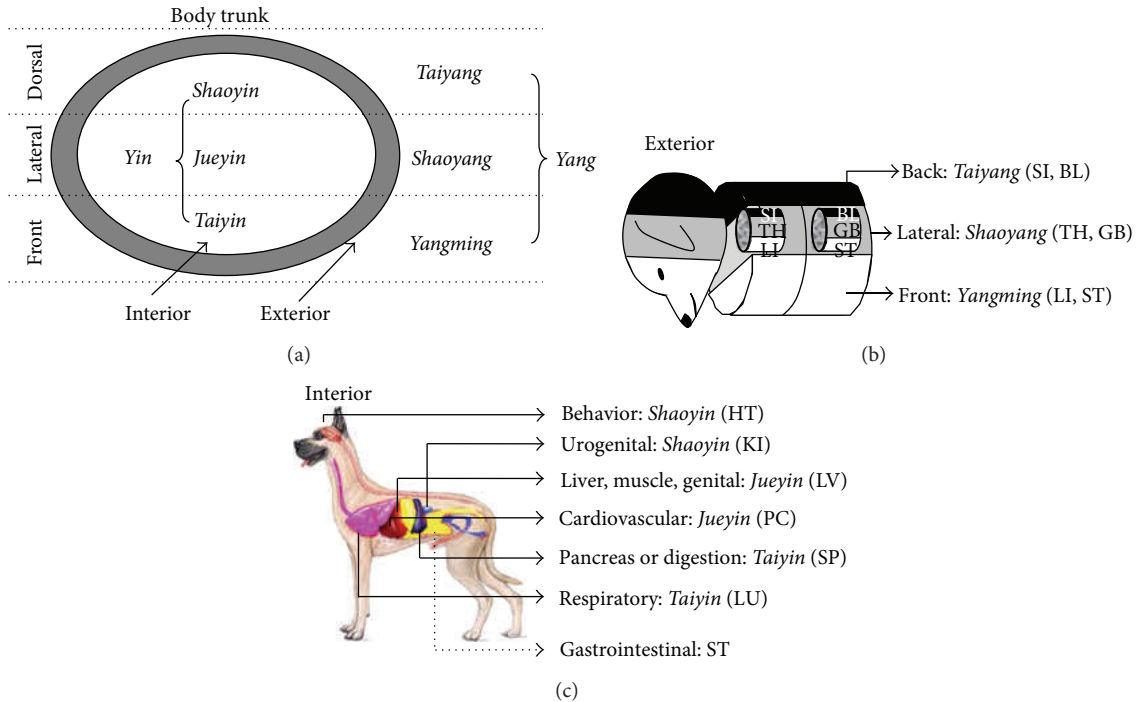

FIGURE 5: Channels and their clinical indications (Step 4). (a) Ancient anatomical terms “3 Yangs-3 Yins” and body. *Yang* and *Yin* represent exterior and interior of body, respectively. The *Yang* (exterior of body) is divided into 3 sub-*Yangs*, namely, *Yangming* (front), *Shaoyang* (lateral), and *Taiyang* (dorsal or back). On the other hand, the *Yin* (interior of body) is divided into 3 sub-*Yins*, namely, *Taiyin* (front organs; lung, spleen), *Jueyin* (middle organs; pericardium, liver), and *Shaoyin* (dorsal organs; heart, kidney). (b) Three *Yang* Channels and Exterior. External body is divided front, lateral and back, and their associated Channels (underlined) were used for disorders of each area. (c) Three *Yin* Channels and Interior. Each *Yin* Channel is used for treatment of their specific internal organs (a and c). Of the *Yang* Channels, the stomach (ST) Channel is especially useful to treat gastrointestinal disorders. The words in *Italic* are Chinese Pinyin. LI, large intestine Channel; ST, stomach Channel; TH, triple heater Channel; GB, gall bladder Channel; SI, small intestine Channel; BL, urinary bladder Channel; LU, lung Channel; SP, spleen Channel; PC, pericardium Channel; LV, liver Channel; HT, heart Channel; KI, kidney Channel.

not responsive to initial treatment of food withdrawals (first 24 hr) and metoclopramide, one or two vomitings were noted up to 12 hr after first acupuncture and thereafter no more vomiting episodes. Chronic cases (>7 days;  $n = 3$ ) suffered from sporadic vomiting of 2-3 times/day, frequently after food intake, recovered over 18.67 days after 6.7 times treatments and required longer periods and more treatments than acute and subacute cases.

**3.3. Diarrhea ( $n=2$ ).** A 1.5-month-old female Poodle dog (acute case) was presented with acute watery diarrhea of 2 episodes within 12 hr. Since the patient still kept normal appetite without dehydration and pyrexia and owner was most favorable toward alternative medicine use, acupuncture was first tried without routine laboratory examinations or Western medicine. The following acupoints were used: PC6, SP4, and ST36 (in Step 1), LV13, and CV12 (in Step 2), sensitive Back-*Shu* and Abdomen-*Mu* points to palpations (in Step 3), ST42, ST36, SP3, and SP9 (in Step 4), and GV1 (in the last Step 5). Increase of stools consistency and decrease of stools frequencies were observed within 48 hr after first acupuncture treatment. She returned to normal over 9 days after two acupuncture treatment. A 6-month-old male mixed dog (subacute case) was presented with acute onset (<2

days) of mild diarrhea, poor appetite, and frequent vomiting. When presented, a complete blood count and routine serum chemistry levels were within normal limits and fecal examinations including parvovirus, distemper virus and parasites were also normal. The patient was first treated with loperamide and amoxicillin for 5 days, but the diarrhea persisted. Acupuncture was then applied at the same points as those of acute diarrhea case. He began to recover appetite on the day of acupuncture treatment and returned to normal consistent feces 2 days after acupuncture treatment.

**3.4. Abdominal Pain ( $n=5$ ).** The cases (2 Maltese, 1 Pug, 1 Cocker spaniel, and 1 miniature Poodle) were initially presented with acute abdominal discomfort, increasing abdominal pain, inappetence, and/or bloating, and they all were lesser than 2 days at duration. Physical examination was normal, except abdominal pain. There was no radiographic evidence for foreign bodies. Acupuncture was performed at the acupoints selected according to the flow chart. They all returned to normal within 24 hours after one acupuncture treatment. Interestingly, when food was offered 30 min after withdrawal of acupuncture needles, 4/5 cases began to eat immediately and did not show any abdominal pain on palpation.

TABLE 2: The acupoints selected according to flow chart and treatment outcome.

Diseases	Severity	Case (n)	The used acupoints	Treatment numbers	Recovery times (day)	Recovered animals/cases
IVDD	Grade I	1	Step 1: SI3, BL62, BL40	1.0	5.00	1/1
	Grade II	1	Step 2: GB34	8.0	49.00	1/1
	Grade III	6	Step 3: sensitive Back- <i>Shu</i> points	12.5	38.67	6/6
	Grade IV	4	Step 4: BL40, BL64 (BL Channel)	15.0	49.00	1/4
Vomiting	Acute	6	Step 5: Baihui, <i>Ashi</i> points near lesion along BL Channel	1.0	0.84	6/6
	Subacute	2	Step 1: PC6, SP4, ST36	1.0	1.00	2/2
	Chronic	3	Step 2: LV13, CV12	6.7	18.67	3/3
		3	Step 3: sensitive Back- <i>Shu</i> and/or Abdomen- <i>Mu</i> points			
Diarrhea	Acute	1	Step 4: ST36, ST42, SP3, SP9 (ST, SP Channels)	2.0	9.00	1/1
	Subacute	1	(Same as those of vomiting) + GV1	1.0	2.00	1/1
	Chronic	0				
Abdominal pain	Acute	5	(Same as those of vomiting)	1.0	0.62	5/5
Cough	Acute	0	Step 1: LU7, KI6, LI4			
	Subacute	66	Step 2: CV17 or LV13	1.9	7.02	54/66
	Chronic	0	Step 3: sensitive <i>Shu</i> and/or <i>Mu</i> points			
Epilepsy			Step 4: LU5, LU9 (LU Channel)			
	<1 year	1	Step 5: CV22	1/week	—	1/1
	>1 year	5	Step 1: SI3, BL62 for posterior brain lesion or TH5, GB41 for unilateral brain lesion	1/week	—	4/5
			Step 2: GB39			
			Step 3: sensitive <i>Shu</i> and/or <i>Mu</i> points			
			Step 4: SI4, SI8, BL40, BL64 for posterior brain lesion (SI, BL Channels) or TH4, TH10, GB34, GB40, for unilateral brain lesion (TH, GB Channels)			
			Step 5: GV20, GB20, GV16, <i>Yintang</i>			

3.5. *Cough* ( $n=66$ ). The coughing cases in this study consisted of 60 shelter and 6 hospital cases. On August and September 2007 in Republic of Korea, workers in two shelters noticed abrupt outbreaks of coughing dogs after rainy spell in summer, although the medications including antibiotics were done under regular shelter program. The most affected dogs were small pure or mixed breeds. Although the exact age of the shelter dogs was usually unknown, ages were estimated to be between 6 months and 7 years old, based on dentition and hair coat. The common clinical signs were cough and nasal discharge for 3–7 days. Under shelter's approval, treatment was performed using acupuncture without Western medicine, at the following acupoints: LU7, KI6, and LI4 (in Step 1), CV17 or LV13 (in Step 2), sensitive Back-*Shu* and Abdomen-*Mu* points to palpations (in Step 3), LU9 and LU5 (in Step 4), and CV22 (in Step 5). Two shelter veterinarians observed daily spontaneous coughing and nasal discharge in acupuncture-treated dogs. At 7 days after one acupuncture treatment, it was noted that 48 dogs showed no symptoms of cough and nasal discharge, and the other 12 had still cough or nasal discharge and thereafter were prescribed antibiotics. The above favorable effects were also observed in 6 hospital cases (1 Poodle, 1 Yorkshire terrier, 3 Shih Tzus, and 1 mixed-breed) within 2–7 days at onset duration of coughing. They received acupuncture treatments two times a week at the same points as those of shelter dogs. Decrease of coughing frequencies was observed on 3 days after first acupuncture

and they all did not show any coughing on the next visits (on 7 days after acupuncture treatment).

3.6. *Epilepsy* ( $n=6$ ). The 6 cases (2 Pugs, 1 Shih Tzu, 1 Maltese, 1 miniature Poodle, and 1 mixed breed) showed recurrent seizure at a frequency of 2–4/month under control of antiepileptic drugs. They were diagnosed as presumed idiopathic epilepsy based on physical and neurological examinations and hematological and serum biochemical analyses. One Maltese dog of 3 months at onset of epileptic seizure received only acupuncture treatment once a week without medication, since his owner was reluctant to give antiepileptic drugs. The other 5 dogs over 1 year at onset of epileptic seizure received regular acupuncture treatment once a month with anticonvulsants. Acupoints were chosen, as shown in (Table 2). Since acupuncture treatment, 5 of the 6 dogs (5/6, 83%) had no epileptic episode during followup of 12 months. However, a 5-year-old male Pug, presented with frequent generalized and symmetrical epilepsy during 1.5 years, did not show any changes in frequencies of epilepsy after acupuncture treatment.

## 4. Discussion

4.1. *The Present Acupuncture Flow Chart Follows Basic OM Principles for Point Combinations*. Although various methods can be used to select effective acupoints in OM, good

prescriptions must satisfy at least basic OM principles. These include (1) bilateral acupuncture, (2) combination of forelimb and hindlimb points, (3) ventral and dorsal points, and (4) local and distal points [7]. The present chart follows all of the above principles. First, each step is bilateral acupuncture. Second, Step 1 includes a combination of points on forelimb and hindlimb. Third, Step 3 is one technique of combining *Mu*-ventral and *Shu*-dorsal points. For example, in vomiting cases, ventral point CV12 and dorsal point BL21 were selected in Step 3. Lastly, a combination of local and distal points is included in Steps 4 and 5. Thus, the present flow chart is well matched with OM principles for point combination.

4.2. *The Proposed Chart Lists 164 Important Acupoints and Is Designed to Select Acupoints in a Total of 5 Steps.* There are approximately 360 acupoints on the 14 main channels of the body. Not all these acupoints are used commonly in veterinary and human clinics. Most acupuncturists pay great attention to the application of special acting acupoints which have special therapeutic effects. These clinically important acupoints are categorized according to their own special therapeutic properties as follows: 8 Extraordinary Channel points, 6 Command points, 8 Influential points, Back-*Shu* and Abdomen-*Mu* points, *Yuan* (source) points and *Luo* (connection) points, and 5 *Shu* (transporting) points, including *He* (sea) points, *Xi* (cleft) points, and empirical points, and local points. In the present chart, the above points were organized in order of the functional ranges of acupoints (from points with broad function to points acting locally) as follows (Figure 1).

Step 1: 8 Extraordinary Channel points (8 points) + 6 Command points (6 points),

Step 2: 8 Influential points (8 points),

Step 3: Back-*Shu* points (12 points) + Abdomen-*Mu* points (12 points),

Step 4: 5 *Shu* (transporting) points on 12 Channels (55 points) + *Xi* (cleft) points (12 points) + *Yuan* (source) points (12 points) + *Luo* (connection) points (12 points),

Step 5: empirical or local points (27 points).

In Step 1, Extraordinary Channel points were combined with Command points because both acupoints groups have the widest range of actions among the acupoints and have similar indications in respects of the body areas, when divided the body into exterior (lateral or back aspects) and interior (heart/gastrointestinal or respiratory/urogenital areas) or upper (face and neck) and lower parts (back). In oriental medicine, 8 Extraordinary Channels and their key points have been considered to play most important roles in balancing body *Qi*. The medical term “8 Extraordinary Channels points” dates back to 1230s and the detailed indications and methods forming 4 pairs of acupoints (i.e., PC6-SP4) were first described in the *Yizong Jinjian* (Golden Mirror of Medicine) written by *Wu Qian* in 1742 [8]. Based on that book, the Extraordinary Channel points are always used in

a pair for disorders of the following body areas: (1) SI3-BL62-back, spine, neck, head, eye, and brain; (2) TH5-GB41-side of body, lateral sides of the lumbar area, lateral aspect of leg, sides of body, shoulders, hip, eyes, ears, and neck; (3) PC6-SP4-heart, thorax, gastrointestinal disorders, and reproductive, and (4) LU7-KI6-respiratory, lower abdominal, and urogenital disorders [9, 10].

To simplify the above theory more, we divided the body into 4 areas of exterior-back aspects, exterior-lateral aspects, interior-heart/gastrointestinal and interior-respiratory/urogenital systems, and assigned paired acupoints to each area (Figures 1 and 2(a)). In our clinical cases (Table 2), a pair of SI3-BL62 was applied to back disorders (IVDD) and bilateral epilepsy which was considered to be caused by posterior (or whole) brain lesions. A pair of TH5-GB41 was used for 1 case with unilateral epilepsy which was presumed to be due to lateral brain lesions, and LU7-KI6 was chosen for 66 coughing cases. And PC6-SP4 points were used for vomiting ( $n = 11$ ), diarrhea ( $n = 2$ ) and abdominal pain ( $n = 5$ ). Previous experimental and clinical studies have successfully applied 8 Extraordinary Channel points. In one clinical study showing successful outcomes of acupuncture in IVDD dogs, paired acupoints of SI3-BL62 were used in combination with other acupoints [11]. TH5-GB41 has been used effectively for unilateral or focal headaches in human [12, 13]. LU7 and/or KI6 in combination with other acupoints has been used successfully for respiratory clinical trials [14–16]. Acupoint PC6 is extensively for treatment and prevention of vomiting [17–23] and the enhancement of cardiopulmonary functions [4, 24–26]. Wang et al. reported that acupoints at PC6 and SP4 enhance cardiac and gastrointestinal functional activities after acute myocardial ischemia through the mediation of nitric oxide (NO) [27].

In Step 1, theoretically, to enhance the effects of Extraordinary Channel points, 6 Command points therapy were added. In detail, the 6 Command points are 6 individual points which have been used to control diseases in 6 major body parts, abdomen (ST36), lumbar region (BL40), neck (LU7), heart (LI4), chest (PC6), and urogenital organ (SP6) [28] (Figure 2(b)). Six Command points originated from 4 Command points (ST36, LI4, LU7 and BL40), described in Chinese classic *Qiankunshengyi* (Meanings of Life between Heaven and Earth; 1402) and formed by adding two points (PC6 and SP6) later [29]. In the present study, one of 6 Command points was chosen additionally in cases of IVDD (BL40) and diarrhea/abdominal pain (ST36). Previous experimental and clinical studies support the effect of the 6 Command points which described in Step 1 of Figure 1. BL40 commonly in previous clinical trials of dogs with IVDD [11, 30]. ST36 is a acupoint, well known to be most effective for gastrointestinal disorders such as abdominal pain, diarrhea, and irritable bowel diseases [3, 31–38]. Acupuncture at SP6, a common point for urinary disorders [39, 40], has shown to decrease symptoms of urinary incontinence by stress in rats [41], diurnal symptoms associated with idiopathic bladder instability [42], and symptoms of frequency, urgency, and dysuria in female cases [43]. Although we could not conclude that the application of these combined points in Step 1 led to the present favorable outcomes, at least this flow chart allows

an easy and fast approach to apply clinically the complicated OM theory concerning 8 Extraordinary Channel and 6 Command points.

In Step 2, one or two of 8 Influential points were selected according to the body components affected by diseases. Eight Influential points are based on a Chinese classic *Nan Jing* (*The Classic of Difficulties*) written around the 2nd century AD. It classifies the body as having 8 components: *Zang*, *Fu*, *Qi*, *Xue* (Blood), *Ji* (Muscle), *Mai* (Vessels), *Gu* (Bone), and *Sui* (Marrow). Each of these has a most influential point that exerts a profound effect on the function of each component [44]. Figure 3 and Step 2 in Figure 1 show 8 body components in OM, interpretation in Western medicine, and their corresponding Influential points. For example, CV12 can be used for disorders of stomach, small intestine and large intestine (*Fu* organs in OM), such as epigastric distention, abdominal pain, constipation, or diarrhea, and GB34 can be selected for muscle-related disorders (*muscle* in OM) such as muscle spasm, painful tendons, and hemiplegia. In our present studies, we chose GB34 for IVDD cases, LV13/CV12 for vomiting, diarrhea, and abdominal pain, and CV17/LV13 for cough and GB39 for epilepsy, respectively. Previous studies have included acupoint(s) of GB34 in IVDD [11, 30], LV13/CV12 in gastrointestinal disorders [34, 45, 46], CV17 in respiratory disorders [47], and GB39 in brain disorders, respectively [48].

In Step 3, Back-*Shu* and Abdomen-*Mu* points showing sensitivity to surgeon's palpation were selected for acupuncture. Figure 4 and Step 3 in Figure 1 show the Back-*Shu* and Abdomen-*Mu* points and the associated internal organs. Oriental medicine describes that Back-*Shu* and Abdomen-*Mu* points are connected directly to the internal organs and these points often become tender, tight, or distended when the associated organs are diseased or imbalanced, and so they are used as diagnostic and treatment points [5, 49]. In support, a retrospective study of 175 dogs and cats with Back-*Shu* or Abdomen-*Mu* point sensitivity and their blood chemistry showed that there is at least a single correlation of the point sensitivity with a concurrent rise in the internal organs-associated chemistry values [49]. Back-*Shu* and Abdomen-*Mu* points are known to be related segmentally to the internal organs [50, 51]. Visceral pain is referred to segmental somatic areas. In the referred area, tender points, characterized by well-defined and localized spots and an increased sensitivity to mechanical stimuli are often found [52]. The stimulation of these tender points can in turn alleviate the visceral pain and inflammation [53–55]. In our present cases, most sensitive points were found at Back-*Shu* and Abdomen-*Mu* points around the affected internal organs and frequently some other points. In the cases with vomiting ( $n = 11$ ) or abdominal pain ( $n = 5$ ), sensitive points were found at BL21 (stomach *Shu* point) and/or CV12 (stomach *Mu* point) and frequently several other points such as BL17 (diaphragm point), BL18 (liver point), BL 19 (gall bladder point), BL 20 (spleen point), BL22, and BL23 (kidney point). Two diarrhea cases were sensitive at BL23/BL25 or BL21/BL24/BL25. In the cough cases, one or two sensitive points at Back-*Shu* points such as BL12 (*wind* point), BL13 (lung point), BL14

(pericardium point), or BL15 (heart point) were found. These above points were stimulated by acupuncture.

In Step 4, one or two of 12 regular Channels were chosen according to main symptoms or diagnosis from Step 3, and then two Main points (*Yuan* and *He* points) were selected on the chosen Channels (Figure 1). Regular Channels are *Qi* pathways to connect the external body with internal organs (*Yin* Channels) or head (*Yang* Channels) [5]. Oriental medicine teaches that diseases occur when the *Qi* flow is disrupted in one or more Channels, which can be relieved by stimulating acupoints on the affected Channels. To differentiate the Channels which were likely to be affected by disorders, we used the “3 *Yang*-3 *Yin* theory” which has been the most important fundament for diagnosis and treatment in acupuncture medicine [56, 57] (Figure 5(a)). In ancient anatomical terms, *Yang* and *Yin* represent exterior and interior of body, respectively. In respect of treatment, *Yang* and *Yin* also represent external (exterior) and internal (interior) disorders, respectively. The *Yang* (exterior of body) is divided into 3 sub-*Yangs*, namely, *Yangming* (front), *Shaoyang* (lateral) and *Taiyang* (back or dorsal), and each of them is used for its corresponding external disorders (Figures 5(a) and 5(b) and Step 4 in Figure 1). In our present study, based on “3 *Yang*-3 *Yin* theory,” IVDD or epilepsy was diagnosed as exterior-back (*Taiyang*) disorder and thus *Taiyang* Channels (SI and BL) were chosen. Then, two Main points *Yuan* (source) and *He* (sea) points on SI and BL Channels were selected for acupuncture. *Shaoyang* Channels (TH and GB) were chosen for epilepsy with clinically presumed unilateral brain lesion (Table 2). On the other hand, the *Yin* (interior of body) is divided into 3 sub-*Yins*, namely, *Taiyin* (front organs; lung, spleen), *Jueyin* (middle organs; pericardium, liver) and *Shaoyin* (dorsal organs; heart, kidney), and each of them is used for treatment of its specific internal organs (Figures 5(a) and 5(c)). Empirically, stomach (ST) Channel of *Yang* Channels has been used to treat internal organs (stomach and intestine), as well as exterior-front disorder. In our present study, cough was diagnosed as interior-front organ-Lung (*Taiyin* LU) disorder, and thus *Taiyin* LU Channel and its Main points (*Yuan* and *He* points) were selected for treatment. Case with vomiting, diarrhea, or abdominal pain was diagnosed as interior-front organ-spleen (*Taiyin* SP) disorder or stomach (ST) disorder, according to sensitivity at BL20 (spleen *Shu* point) or BL21 (stomach *Shu* point) and two Main points were selected on SP (spleen) or ST (stomach) Channels (Table 2). Although the above Channel theory is most important in acupuncture medicine, it is true that the theory is too difficult for general clinicians to comprehend. Therefore, we highly simplified clinical indications of each Channel and summarized it in Step 4 (Figure 1).

In Step 5, local, empirical, or *Ashi* (local sensitive) points for each case were added. Acupuncture needling is known to produce local anti-inflammatory, analgesic, and antipyretic effects by promoting vasodilation and blood flow locally and releasing neuromodulators [58]. In the present cases, we chose GV1 in diarrhea, CV22 in cough, and GV20/GB20/GV16/*Yintang* in epilepsy, respectively. GV1 is a single acupoint in the depression ventral to the base of the tail and dorsal to the anus. It is one of the most effective acupoints to



treat diarrhea in humans and animals [59–61]. Our previous studies demonstrated that acupuncture at GV1 depressed proximal colonic motility by decreasing the total duration and frequency of contractile states in conscious dogs and also had anti-inflammatory and analgesic effects in colitis rats, via endogenous opioid pathways [54, 55, 62]. CV22 has been included to treat respiratory disorders [63, 64]. GV20, GB20, GV16, or Yintang points have been used commonly for brain disorders such as headache [65]. Previous reports has shown that acupuncture at *Yintang* and/or GV20 can cause sedative effects and change bioelectrical brain activity [66]. Although we could not determine which acupoint in flow chart was most effective for the treatment of each case, each step in this flow chart provides a theoretical rationale for selection of optimal acupoints in each case, based on OM theory.

*4.3. The Proposed Chart Can Help Clinicians Prescribe Acupoints Effectively for Various Diseases.* In 1997, the NIH released a consensus statement concluding that acupuncture is effective or at least useful for the treatment of 13 conditions including low back pain, nausea and vomiting, asthma, stroke rehabilitation, headache, addiction, dental pain, menstrual cramps, tennis elbow, fibromyalgia, myofascial pain, osteoarthritis, and carpal tunnel syndrome [67]. Multiple studies have documented that acupuncture is useful in the case with low back pain or IVDD when a definitive diagnosis is made or when surgical intervention is not an option due to patient concerns such as geriatric and other underlying diseases, and acupuncture results are favorable and comparable to those of surgical treatments [30, 68–75]. In veterinary medicine, the success rates and recovery periods by acupuncture in IVDD dogs seem to vary according to the severity of disease. In clinical reports of Janssens LA [76], 90% of dogs with grade I recovered after 2–3 treatment over 1–2 week period, 90% of dogs with grade II recovered after 3–4 treatment over a 3-week period, and 80% dogs with grade III recovered after 5–6 treatments over a 6-week period. And dogs with grade IV showed poor response to acupuncture (success rate < 25%). Similarly, in our present study, 100% in dogs of grades I to III recovered over periods from 5 days to 6 weeks after 1–12 treatments, while only 1/4 dogs in grade IV recovered over 7 weeks after 15 treatments. It seemed that as the severity of IVDD increased, the recovery period and number of treatments also increased. Acupuncture treatment of idiopathic epilepsy has been documented well in the veterinary and human literature [5, 57, 68]. It was reported that acupuncture reduces seizure frequency and dosage requirements of antiepileptic drugs in epileptic dogs [77–80]. In our present study, 5/6 dogs with epileptic episode at a frequency of 2–4/month showed no seizures under combination therapy of acupuncture and anticonvulsants. It indicates that this flow chart may be useful for neurological cases with IVDD or epilepsy.

Acupuncture is used extensively for gastrointestinal disorders, such as vomiting, diarrhea, and abdominal pain. It decreases the severity of nausea and emesis from a variety of causes in humans and dogs [18, 20, 21, 67]. In the present study, all dogs with vomiting ( $n = 11$ ), diarrhea ( $n = 2$ ), and

abdominal pain ( $n = 5$ ) recovered after 1–6 treatments over 1–19 days. Most acute/subacute cases (<7 days at duration) fully recovered within 1 day after one acupuncture treatment, without Western medicine. Interestingly 3/6 acute vomiting cases began to eat foods within 1 hr after withdrawal of acupuncture needles and 4/5 abdominal pain cases showed complete relief of abdominal pain within 30 min after withdrawal of acupuncture needles, with no recurrence. Similarly, in one human clinical study of 190 cases with intestinal colic pain from bacillary dysentery, simple acute appendicitis, simple acute intestinal obstruction, adhesive intestinal obstruction, or intestinal ascariasis, acupuncture at bilateral ST36 results in complete pain relief within 30 min in 85% of cases, decreased colic pain in 11%, and no response in 4% [81]. To our knowledge, although it has limitations to explain these phenomena scientifically, our results show that this flow chart can help the clinicians prescribe acupoints effectively for cases with various gastrointestinal symptoms. Acupuncture may have beneficial effects on the treatment of respiratory diseases including bronchitis and asthma in dogs and cats [82]. Although this was an uncontrolled clinical study, and not a randomised controlled clinical trial, our results that acupuncture improved 54/66 coughing cases showed that acupuncture methods using this flow chart can be used to help the treatment of respiratory cases.

## 5. Conclusion

This acupoints prescription chart is based on oriental medical (OM) theory and includes information concerning OM diagnosis, function of the Channels, *Zang-Fu* theory, clinically important acupoints, and combination methods of their acupoints. It has been modified through clinical trials since first edition in 2003 and used widely and successfully to various clinical cases such as neurological, respiratory, and gastrointestinal disorders in Korean veterinary clinics. We believe that this chart helps beginners or clinicians to select effective acupuncture points easily and quickly. However, more powerful methods of well-designed randomized and controlled trials are needed to confirm the efficacy of this flow chart on various diseases.

## Acknowledgments

This work was supported by the National Research Foundation of Korea (NRF) grant funded by the Korea Government (MEST) (no. 20120009400). The authors thank Phil Rogers MRCVS, Dublin, for editing the material in this paper. Hee Young Kim also appreciates and acknowledges the support for the basic course on veterinary acupuncture (2007–2008, San Antonio, USA) provided by the International Veterinary Acupuncture Society (IVAS) via the Grady Young Memorial Scholarship program.

## References

- [1] D. H. Jaggar and N. G. Robinson, "History of veterinary acupuncture," in *Veterinary Acupuncture: Ancient Art to Modern Medicine*, A. M. Schoen, Ed., pp. 3–17, Mosby, St. Louis, Mo, USA, 2002.

- [2] A. Shiotani, M. Tatewaki, E. Hoshino, and T. Takahashi, "Effects of electroacupuncture on gastric myoelectrical activity in healthy humans," *Neurogastroenterology and Motility*, vol. 16, no. 3, pp. 293–298, 2004.
- [3] S. Xu, Z. Liu, and M. Xu, "Treatment of cancerous abdominal pain by acupuncture on zusanli (ST 36)—a report of 92 cases," *Journal of Traditional Chinese Medicine*, vol. 15, no. 3, pp. 189–191, 1995.
- [4] M. T. Tsou, C. H. Huang, and J. H. Chiu, "Electroacupuncture on PC6 (Neiguan) attenuates ischemia/reperfusion injury in rat hearts," *The American Journal of Chinese Medicine*, vol. 32, no. 6, pp. 951–965, 2004.
- [5] H. Kim, I. Shim, D. Hahm et al., *Canine Acupuncture*, Korvet, Seoul, Republic of Korea, 2004.
- [6] J. R. Coates, "Intervertebral disk disease," *Veterinary Clinics of North America—Small Animal Practice*, vol. 30, no. 1, pp. 77–110, 2000.
- [7] M. H. Glinski, "Point selection," in *Veterinary Acupuncture: Ancient Art to Modern Medicine*, A. M. Schoen, Ed., pp. 113–124, Mosby, St. Louis, Mo, USA, 2001.
- [8] G. S. Lee and J. H. Yoon, "Study about eight extraordinary vessels and eight extraordinary vessels points," *Journal of Korean Academy of Medical Gi-Gong*, vol. 2, no. 1, pp. 103–118, 1998.
- [9] G. Maciocia, *The Foundations of Chinese Medicine: A Comprehensive Text for Acupuncturists and Herbalists*, Churchill Livingstone, 1989.
- [10] J. Y. Jang, S. Y. Park, J. A. Hong et al., "A literary study on combination of Yeolgeol (LU7) and Johae (KI6) of eight confluent acupoints," *The Korean Journal of Meridian and Acupoint*, vol. 23, pp. 27–47, 2006.
- [11] A. M. Hayashi, J. M. Matera, and A. C. B. D. C. F. Pinto, "Evaluation of electroacupuncture treatment for thoracolumbar intervertebral disk disease in dogs," *Journal of the American Veterinary Medical Association*, vol. 231, no. 6, pp. 913–918, 2007.
- [12] A. Kuruvilla, "Acupuncture outcome of patients with migraine," *Medical Acupuncture*, vol. 19, no. 3, pp. 137–140, 2007.
- [13] M. Karst, M. Reinhard, P. Thum, B. Wiese, J. Rollnik, and M. Fink, "Needle acupuncture in tension-type headache: a randomized, placebo-controlled study," *Cephalalgia*, vol. 21, no. 6, pp. 637–642, 2001.
- [14] E. Peuker, "Case report of tension pneumothorax related to acupuncture," *Acupuncture in Medicine*, vol. 22, no. 1, pp. 40–43, 2004.
- [15] W. Zwölfer, W. Keznickl-Hillebrand, A. Spacek, M. Cartellieri, and G. Grubhofer, "Beneficial effect of acupuncture on adult patients with asthma bronchiale," *The American Journal of Chinese Medicine*, vol. 21, no. 2, pp. 113–117, 1993.
- [16] A. O. Freire, G. C. M. Sugai, F. S. Chrispin et al., "Treatment of moderate obstructive sleep apnea syndrome with acupuncture: a randomised, placebo-controlled pilot trial," *Sleep Medicine*, vol. 8, no. 1, pp. 43–50, 2007.
- [17] E. Nystrom, G. Ridderstrom, and A. S. Leffler, "Manual acupuncture as an adjunctive treatment of nausea in patients with cancer in palliative care—a prospective, observational pilot study," *Acupuncture in Medicine*, vol. 26, no. 1, pp. 27–32, 2008.
- [18] G. Gardani, R. Cerrone, C. Biella et al., "A progress study of 100 cancer patients treated by acupressure for chemotherapy-induced vomiting after failure with the pharmacological approach," *Minerva Medica*, vol. 98, no. 6, pp. 665–668, 2007.
- [19] G. Gardani, R. Cerrone, C. Biella et al., "Effect of acupressure on nausea and vomiting induced by chemotherapy in cancer patients," *Minerva Medica*, vol. 97, no. 5, pp. 391–394, 2006.
- [20] M. Tatewaki, C. Strickland, H. Fukuda et al., "Effects of acupuncture on vasopressin-induced emesis in conscious dogs," *The American Journal of Physiology*, vol. 288, no. 2, pp. R401–R408, 2005.
- [21] H. E. Dent, N. G. Dewhurst, S. Y. Mills, and M. Willoughby, "Continuous PC6 wristband acupressure for relief of nausea and vomiting associated with acute myocardial infarction: a partially randomised, placebo-controlled trial," *Complementary Therapies in Medicine*, vol. 11, no. 2, pp. 72–77, 2003.
- [22] C. P. O. Carlsson, P. Axemo, A. Bodin et al., "Manual acupuncture reduces hyperemesis gravidarum: a placebo-controlled, randomized, single-blind, crossover study," *Journal of Pain and Symptom Management*, vol. 20, no. 4, pp. 273–279, 2000.
- [23] M. Al-Sadi, B. Newman, and S. A. Julious, "Acupuncture in the prevention of postoperative nausea and vomiting," *Anaesthesia*, vol. 52, no. 7, pp. 658–661, 1997.
- [24] J. G. Lin, S. J. Ho, and J. C. Lin, "Effect of acupuncture on cardiopulmonary function," *Chinese Medical Journal*, vol. 109, no. 6, pp. 482–485, 1996.
- [25] J. Gao, W. Fu, Z. Jin, and X. Yu, "A preliminary study on the cardioprotection of acupuncture pretreatment in rats with ischemia and reperfusion: involvement of cardiac  $\beta$ -adrenoceptors," *Journal of Physiological Sciences*, vol. 56, no. 4, pp. 275–279, 2006.
- [26] J. Gao, W. Fu, Z. Jin, and X. Yu, "Acupuncture pretreatment protects heart from injury in rats with myocardial ischemia and reperfusion via inhibition of the  $\beta$ 1-adrenoceptor signaling pathway," *Life Sciences*, vol. 80, no. 16, pp. 1484–1489, 2007.
- [27] S. B. Wang, S. P. Chen, Y. H. Gao, M. F. Luo, and J. L. Liu, "Effects of electroacupuncture on cardiac and gastric activities in acute myocardial ischemia rats," *World Journal of Gastroenterology*, vol. 14, no. 42, pp. 6496–6502, 2008.
- [28] H. C. Jeong and I. C. Sohn, "A literary study of four command points," *The Journal of Korean Acupuncture and Moxibustion Society*, vol. 13, no. 1, pp. 292–306, 1996.
- [29] Y. An, *All Guide of Acupuncture*, 2002.
- [30] S. M. Jeong and S. W. Park, "Application of traditional acupuncture on canine intervertebral disc disease," *Journal of Veterinary Clinics*, vol. 21, no. 1, pp. 49–52, 2004.
- [31] K. M. Cui, W. M. Li, X. Gao, K. Chung, J. M. Chung, and G. C. Wu, "Electro-acupuncture relieves chronic visceral hyperalgesia in rats," *Neuroscience Letters*, vol. 376, no. 1, pp. 20–23, 2005.
- [32] J. Xing, B. Larive, N. Mekhail, and E. Soffer, "Transcutaneous electrical acustimulation can reduce visceral perception in patients with the irritable bowel syndrome: a pilot study," *Alternative Therapies in Health and Medicine*, vol. 10, no. 1, pp. 38–42, 2004.
- [33] M. T. Cabýoglu, N. Ergene, and U. Tan, "The mechanism of acupuncture and clinical applications," *International Journal of Neuroscience*, vol. 116, no. 2, pp. 115–125, 2006.
- [34] H. Qin-Feng and Q. Li-Zhen, "Treatment of chronic gastritis by acupuncture: a review," *Journal of Acupuncture and Tuina Science*, vol. 3, no. 2, pp. 7–8, 2005.
- [35] M. Iwa, Y. Nakade, T. N. Pappas, and T. Takahashi, "Electroacupuncture improves restraint stress-induced delay of gastric emptying via central glutaminergic pathways in conscious rats," *Neuroscience Letters*, vol. 399, no. 1–2, pp. 6–10, 2006.
- [36] M. Iwa, M. Matsushima, Y. Nakade, T. N. Pappas, M. Fujimiya, and T. Takahashi, "Electroacupuncture at ST-36 accelerates colonic motility and transit in freely moving conscious rats," *The American Journal of Physiology*, vol. 290, no. 2, pp. G285–G292, 2006.

- [37] L. Tian, Y. X. Huang, M. Tian, W. Gao, and Q. Chang, "Down-regulation of electroacupuncture at ST36 on TNF- $\alpha$  in rats with ulcerative colitis," *World Journal of Gastroenterology*, vol. 9, no. 5, pp. 1028–1033, 2003.
- [38] D. Luo, S. Liu, X. Xie, and X. Hou, "Electroacupuncture at acupoint ST-36 promotes contractility of distal colon via a cholinergic pathway in conscious rats," *Digestive Diseases and Sciences*, vol. 53, no. 3, pp. 689–693, 2008.
- [39] W. M. Yi, J. J. Li, X. M. Lu, L. L. Jin, A. Z. Pan, and Y. Q. Zou, "Effects of electroacupuncture on urinary bladder function after radical hysterectomy," *Zhongguo Zhen Jiu*, vol. 28, no. 9, pp. 653–655, 2008.
- [40] S. O. Aschkenazi and P. K. Sand, *Alternative Therapies for Urinary Urgency Incontinence: Acupuncture and Herbology*, Springer, London, UK, 2009.
- [41] I. M. Chung, Y. S. Kim, Y. H. Sung et al., "Effects of acupuncture on abdominal leak point pressure and c-Fos expression in the brain of rats with stress urinary incontinence," *Neuroscience Letters*, vol. 439, no. 1, pp. 18–23, 2008.
- [42] T. Philp, P. J. R. Shah, and P. H. L. Worth, "Acupuncture in the treatment of bladder instability," *The British Journal of Urology*, vol. 61, no. 6, pp. 490–493, 1988.
- [43] P. L. Chang, C. J. Wu, and M. H. Huang, "Long-term outcome of acupuncture in women with frequency, urgency and dysuria," *The American Journal of Chinese Medicine*, vol. 21, no. 3–4, pp. 231–236, 1993.
- [44] B. H. Lee and J. Y. Moon, "The study of meaning and formation system of Pal Hyue Hyul (eight influential points) through Hwangjaenaekyong," *The Journal of Korean Acupuncture and Moxibustion Society*, vol. 22, no. 6, pp. 101–109, 2005.
- [45] T. Takahashi, "Acupuncture for functional gastrointestinal disorders," *Journal of Gastroenterology*, vol. 41, no. 5, pp. 408–417, 2006.
- [46] Y. S. Kim, K. W. Kim, J. Y. Kim et al., "The anti-emetic effect of needling acupuncture, aquapuncture and moxibustion at BL-21 and CV-12 in xylazine induced vomiting of dogs," *Journal of Veterinary Clinics*, vol. 22, no. 3, pp. 202–205, 2005.
- [47] S. Y. Zhang, "Treatment of 200 cases of asthma by fat-cut therapy," *Journal of Acupuncture and Tuina Science*, vol. 3, no. 3, pp. 24–25, 2005.
- [48] C. H. Lee, T. H. Kim, S. Y. Lee et al., "Neuroanatomical studies on acupoints (SJ5, Pe6, SP6 and GB39) projecting to the brain area related to dementia using neural tracer, pseudorabies virus in mouse," *The Journal of Korean Acupuncture and Moxibustion Society*, vol. 20, no. 6, pp. 168–181, 2003.
- [49] C. Schwarz, "Traditional Chinese medical diagnosis in small animals," in *Veterinary Acupuncture: Ancient Art to Modern Medicine*, A. M. Schoen, Ed., pp. 149–160, Mosby, St. Louis, Mo, USA, 2001.
- [50] D. F. Mayor, "The Chinese back shu and front mu points and their segmental innervation," *Deutsche Zeitschrift fur Akupunktur*, vol. 51, no. 2, pp. 26–36, 2008.
- [51] W. Cai, "Acupuncture and the nervous system," *The American Journal of Chinese Medicine*, vol. 20, no. 3–4, pp. 331–337, 1992.
- [52] M. A. Giamberardino, "Recent and forgotten aspects of visceral pain," *European Journal of Pain*, vol. 3, no. 2, pp. 77–92, 1999.
- [53] B. Coffin, F. Azpiroz, and J. R. Malagelada, "Somatic stimulation reduces perception of gut distention in humans," *Gastroenterology*, vol. 107, no. 6, pp. 1636–1642, 1994.
- [54] H. Y. Kim, D. H. Hahm, K. H. Pyun et al., "Effects of acupuncture at GV01 on experimentally induced colitis in rats: possible involvement of the opioid system," *Japanese Journal of Physiology*, vol. 55, no. 3, pp. 205–210, 2005.
- [55] H. Y. Kim, D. H. Hahm, B. Y. Sohn et al., "Skin on GV01 acupoint in colonic inflammatory states: tenderness and neurogenic inflammation," *Journal of Physiological Sciences*, vol. 56, no. 4, pp. 317–320, 2006.
- [56] C. S. Yin, M. K. Kang, S. H. Lee et al., "A study of three pairs of Yin and Yang acupoints in Dunhuang books on ancient medicine," *The Journal of Korean Acupuncture and Moxibustion Society*, vol. 19, no. 4, pp. 42–48, 2002.
- [57] S. B. Kang, *Acupuncture and Moxibustion Based on Ancient Books*, Iljung, Seoul, Republic of Korea, 2000.
- [58] J. E. Steiss, "The neurophysiologic basis of acupuncture," in *Veterinary Acupuncture*, A. Schoen, Ed., pp. 27–46, Mosby, St. Louis, Mo, USA, 2001.
- [59] E. S. Park, S. Jo, J. K. Seong et al., "Effect of acupuncture in the treatment of young pigs with induced *Escherichia coli* diarrhea," *Journal of Veterinary Science*, vol. 4, no. 2, pp. 125–128, 2003.
- [60] Y. C. Hwang and E. M. Jenkins, "Effect of acupuncture on young pigs with induced enteropathogenic *Escherichia coli* diarrhea," *American Journal of Veterinary Research*, vol. 49, no. 9, pp. 1641–1643, 1988.
- [61] K. J. Jang, "A bibliographic study on the research of meridian point GV1," *Journal of Korea Acupuncture and Moxibustion Society*, vol. 13, pp. 384–391, 1996.
- [62] H. Y. Kim, D. H. Hahm, Y. Chae et al., "Acupuncture at GV01 relieves somatic pain referred by colitis in rats," *Journal of Physiological Sciences*, vol. 57, no. 4, pp. 253–258, 2007.
- [63] L. Z. Qi, Q. F. Huang, and L. Li-gong, "Treatment of asthma by acupuncture: a review," *Journal of Acupuncture and Tuina Science*, vol. 3, no. 3, pp. 3–5, 2005.
- [64] H. Xie, *Acupuncture for Internal Medicine*, John Wiley & Sons, New York, NY, USA, 2007.
- [65] R. R. Coeytaux, W. Chen, C. E. Lindemuth, Y. Tan, and A. C. Reilly, "Variability in the diagnosis and point selection for persons with frequent headache by traditional Chinese medicine acupuncturists," *Journal of Alternative and Complementary Medicine*, vol. 12, no. 9, pp. 863–872, 2006.
- [66] G. Litscher, "Ten years evidence-based high-tech acupuncture part 3: a short review of animal experiments," *Evidence-Based Complementary and Alternative Medicine*, vol. 7, no. 2, pp. 151–155, 2010.
- [67] S. S. Morey, "NIH issues consensus statement on acupuncture," *The American Family Physician*, vol. 57, no. 10, pp. 2545–2546, 1998.
- [68] K. L. Kline, "Complementary and alternative medicine for neurologic disorders," *Clinical Techniques in Small Animal Practice*, vol. 17, no. 1, pp. 25–33, 2002.
- [69] T. D. Scavelli and A. Schoen, "Problems and complications associated with the nonsurgical management of intervertebral disc disease," *Problems in Veterinary Medicine*, vol. 1, no. 3, pp. 402–414, 1989.
- [70] L. A. Janssens, "Acupuncture for the treatment of thoracolumbar and cervical disc disease in the dog," *Problems in Veterinary Medicine*, vol. 4, no. 1, pp. 107–116, 1992.
- [71] J. Still, "A clinical study of auriculotherapy in canine thoracolumbar disc disease," *Journal of the South African Veterinary Association*, vol. 61, no. 3, pp. 102–105, 1990.
- [72] L. A. Janssens and P. A. Rogers, "Acupuncture versus surgery in canine thoracolumbar disc disease," *Veterinary Record*, vol. 124, no. 11, article 283, 1989.

- [73] R. Buchli, "Successful acupuncture treatment of a cervical disc syndrome in a dog," *Veterinary Medicine, Small Animal Clinician*, vol. 70, no. 11, article 1302, 1975.
- [74] A. M. Lubbe, "Auriculotherapy in canine thoracolumbar disc disease," *Journal of the South African Veterinary Association*, vol. 61, no. 4, article 187, 1990.
- [75] A. M. Hayashi, J. M. Matera, T. S. da Silva, A. C. B. D. C. F. Pinto, and S. R. G. Cortopassi, "Electro-acupuncture and Chinese herbs for treatment of cervical intervertebral disk disease in a dog," *Journal of Veterinary Science*, vol. 8, no. 1, pp. 95–98, 2007.
- [76] L. A. Janssens, "Acupuncture for thoracolumbar and cervical disk disease," in *Veterinary Acupuncture: Ancient Art to Modern Medicine*, A. M. Schoen, Ed., pp. 193–198, Mosby, St. Louis, Mo, USA, 2002.
- [77] J. van Niekerk and N. Eckersley, "The use of acupuncture in canine epilepsy," *Journal of the South African Veterinary Association*, vol. 59, no. 1, article 5, 1988.
- [78] A. M. Klide, G. C. Farnbach, and S. M. Gallagher, "Acupuncture therapy for the treatment of intractable, idiopathic epilepsy in five dogs," *Acupuncture and Electro-Therapeutics Research*, vol. 12, no. 1, pp. 71–74, 1987.
- [79] T. E. Durkes, "Gold bead implants," *Problems in Veterinary Medicine*, vol. 4, no. 1, pp. 207–211, 1992.
- [80] R. B. Panzer and C. L. Chrisman, "An auricular acupuncture treatment for idiopathic canine epilepsy: a preliminary report," *The American Journal of Chinese Medicine*, vol. 22, no. 1, pp. 11–17, 1994.
- [81] R. Jiang, "Analgesic effect of acupuncture on acute intestinal colic in 190 cases," *Journal of Traditional Chinese Medicine*, vol. 10, no. 1, pp. 20–21, 1990.
- [82] C. Schwartz, "Chronic respiratory conditions and acupuncture therapy," *Problems in Veterinary Medicine*, vol. 4, no. 1, pp. 136–143, 1992.

## Research Article

# Effect of Siguan Acupuncture on Gastrointestinal Motility: A Randomized, Sham-Controlled, Crossover Trial

Kyung-Min Shin,<sup>1</sup> Ji-Eun Park,<sup>1</sup> Sanghun Lee,<sup>1</sup> Sun-Mi Choi,<sup>1</sup>  
Yo-Chan Ahn,<sup>2</sup> Jin-Woo Lee,<sup>3</sup> Jin-Hee Kim,<sup>4</sup> and Chang-Gue Son<sup>4</sup>

<sup>1</sup> Department of Medical Research, Korea Institute of Oriental Medicine, Daejeon, Republic of Korea

<sup>2</sup> Department of Health Service Management, Daejeon University, Daejeon, Republic of Korea

<sup>3</sup> Department of Radiology, Oriental Hospital of Daejeon University, Daejeon, Republic of Korea

<sup>4</sup> Liver and Immunology Research Center, Oriental Hospital of Daejeon University, 22-5 Daejung-dong, Jung-gu, Daejeon 301-724, Republic of Korea

Correspondence should be addressed to Chang-Gue Son; ckson@dju.ac.kr

Received 15 March 2013; Revised 17 April 2013; Accepted 19 April 2013

Academic Editor: Younbyoung Chae

Copyright © 2013 Kyung-Min Shin et al. This is an open access article distributed under the Creative Commons Attribution License, which permits unrestricted use, distribution, and reproduction in any medium, provided the original work is properly cited.

Siguan acupoints have been used to treat gastrointestinal symptoms in acupuncture practices for a long time. This study aimed to investigate the effects of Siguan acupuncture on gastrointestinal motility under accelerated conditions using a randomized, sham-acupuncture-controlled, crossover study. Twenty-one healthy male subjects were hospitalized and randomized into either a real acupuncture group (at Siguan acupoints) or a sham acupuncture group. Subjects were administered with mosapride citrate (15 mg a day) for 2 days starting 24 hours before the first acupuncture treatment. Immediately after the administration of radio markers, acupuncture treatment was conducted 4 times at 12-hour intervals. Gastrointestinal motility was assessed using radiograph distribution of the radio-markers located in the small intestine, ascending colon, transverse colon, descending colon, rectum, and outside the body immediately after the first acupuncture treatment and at 6, 12, 24, and 48 hours. After a 2-week washout period, the real acupuncture group in the first session was treated with sham acupuncture in the second session, and vice versa. Gastrointestinal motility was generally reduced in the real acupuncture group compared with the sham acupuncture group throughout the 4 different time points. A significant difference was observed at 24 hours following the first acupuncture treatment ( $P < 0.05$ ).

## 1. Introduction

Acupuncture is a typical therapy applied in traditional Chinese and Korean medicine that stimulates specific acupoints on the human body either manually or electronically. The medical application rates of acupuncture have steadily increased for various conditions, including pain, obesity, stroke rehabilitation, gastrointestinal disorders, psychological illnesses, and metabolic diseases [1].

The effects of acupuncture treatment may depend on the selected acupoints, the combination of acupoints, and the intensity of stimulation. Siguan acupoints (a combination of bilateral LI4 and LR3, meaning “four gates” in Chinese) are the most commonly used acupoints for various symptoms,

especially gastrointestinal (GI) symptoms such as constipation and diarrhea [2, 3].

Traditional Chinese medicine stresses that acupuncture is applied to restore a balance between “ying” and “yang” and to regulate the flow of “qi” and “blood.” The mechanisms of acupuncture are unclear; however, many studies have reported that acupuncture treatment contributes to the maintenance of the biochemical balance of the central nervous system [4, 5]. According to traditional meridian theory, acupuncture functions via homeostatic mechanisms [6]. Therefore, acupuncture performed at the same acupoints can be used to treat the opposing symptoms. For example, acupuncture performed at GV20 has been shown to be

TABLE 1: Demographics of study participants at baseline.

	Mean $\pm$ SD ( <i>n</i> = 21)	Minimum	Maximum
Age (year)	22.0 $\pm$ 1.9	19	25
Height (cm)	173.0 $\pm$ 34.3	165	183
Weight (kg)	71.0 $\pm$ 8.0	59	88
Body temperature ( $^{\circ}$ C)	36.6 $\pm$ 0.2	36	37
Blood pressure (mmHg)			
Systolic	120.0 $\pm$ 8.7	100	130
Diastolic	80.0 $\pm$ 6.0	70	90
Pulse (beats/min)	74.0 $\pm$ 5.8	58	82

Results are reported as mean  $\pm$  standard deviation (SD).

effective in the treatment of hypertension [7] and hypotension [8]. Additionally, the same stimuli performed at the same acupoints induce different responses depending on the physiological or pathological state of the body. Acupuncture performed at LI4 and PC6 reduces heart rate variability when the patient is in a state of fatigue, but it has no effect when the individual is in a normal state [9].

Based upon the previous observations, we hypothesized that Siguan acupuncture affects GI motility as normalizing manners depend on normal, suppressed and excessive status. We previously showed that Siguan acupuncture does not influence GI motility in healthy subjects [10], while it accelerates GI motility in individuals in a loperamide-induced suppressed condition [11].

As a serial study, we conducted an additional trial to understand whether Siguan acupuncture reduces the activity of GI motility under mosapride citrate-induced excessive condition.

## 2. Materials and Methods

**2.1. Subjects.** Twenty-three healthy male subjects were recruited in this study. Only those who had normal finding of complete blood count, liver function test, urinary test, and radiographic investigation (simple abdomen) and were negative for human immunodeficiency virus (HIV), hepatitis B virus (HBV), and hepatitis C virus (HCV) were allowed to participate. Subjects were excluded from the study if they had symptoms of constipation or diarrhea, a diagnosis of irritable bowel syndrome or functional constipation, inflammatory bowel disease or other structural bowel diseases, or other significant disorders or diseases that could interfere with the completion of the study. Participants who smoked or drank alcohol 3 days prior to trial inclusion were also excluded. Finally, 21 healthy subjects (median age: 22 years, range: 19–25 years; median height: 173 cm, range: 165–183 cm; and median weight: 71 kg, range: 59–88 kg) were enrolled in this study (Table 1).

The study was conducted in accordance with the Declaration of Helsinki, and written informed consent was obtained from each participant prior to study enrollment. The study was approved by the Institutional Review Board

of Daejeon University Hospital, Daejeon, Republic of Korea (Authorization number DJOMC-89).

**2.2. Study Design.** This study was a single-blind, randomized, crossover, sham-acupuncture-controlled clinical trial performed to evaluate the effect of Siguan acupuncture under mosapride citrate-induced excessive conditions of GI motility. A Korean Medical Doctor (KMD) initially screened each potential participant against the inclusion and exclusion criteria. Next, eligible participants were randomized in a crossover manner into either a real acupuncture group (RA group, acupunctured at Siguan points) or a sham acupuncture group (SA group, minimal-acupuncture applied at nonacupoints). A 2-week washout period was included between the two sessions; the RA group in the first session was treated with SA in the second session, and vice versa (Figure 1).

All subjects were hospitalized, and then an excessive condition of GI motility was induced using a GI movement modifier. All subjects were administered 15 mg of mosapride citrate (divided three, Gasmotin Tab. Daewoong Pharmaceutical Co. Ltd, Seoul, Republic of Korea) per day starting from the day prior to the first acupuncture treatment and continuing for 2 days. For assessment of GI motility, all participants were administered radio markers (Kolomaker TM; GAIA Medical Corporation, Seoul, Republic of Korea) immediately before the first acupuncture treatment, and GI motility was measured via radiography immediately after the first acupuncture treatment and at 6, 12, 24, and 48 hours thereafter (Figure 2). Additionally, the frequency of defecation was monitored starting from 1 day before the acupuncture treatment to 2 days thereafter. Blood pressure was monitored once a day, and adverse events were assessed.

**2.3. Acupuncture Treatment.** For the RA group, the needle was inserted perpendicularly at an approximate depth of 1 cm at bilateral LI4 and LR3 and rotated 90 degrees 5 times to provoke a *De-qi* sensation in the sequential order as follows: right hand, left hand, right foot, and left foot. For the SA group, the needle was inserted at a depth of 0.3–0.5 cm (transversely toward the lateral side), and no manipulation of the needle was performed to avoid inducing *De-qi*. The size of the acupuncture needle (gauge, 30; diameter, 0.30 mm; Dongbang Healthcare Products, Seoul, Republic of Korea), retaining time (20 minutes), and treatment frequencies were consistent between the two groups. The acupuncture treatment was conducted 4 times at 12-hour intervals. In the SA group, a sham point of LI4 was localized at the middle of the junction of the capitate bone and the third metacarpal bone, while a sham point of LR3 was localized at the middle of the junction of the lateral cuneiform bone and the third metatarsal bone (Figure 3(a)). The practitioner was acupuncture specialist who has had 20 years of clinical experience in oriental internal medicine.

**2.4. Radiological Analysis.** GI motility was analyzed using the exponential weighted score (EWS) method [12]; the presence of each radio marker located in the small intestine, ascending colon, transverse colon, descending colon, rectum,

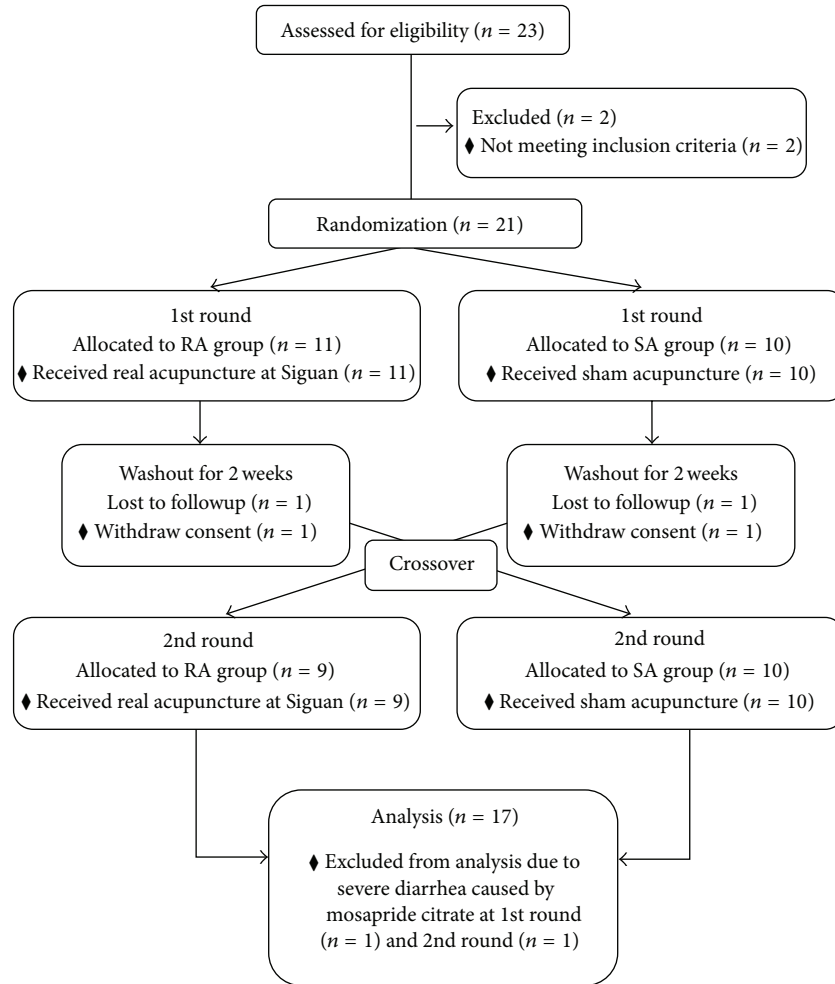

FIGURE 1: CONSORT flow chart.

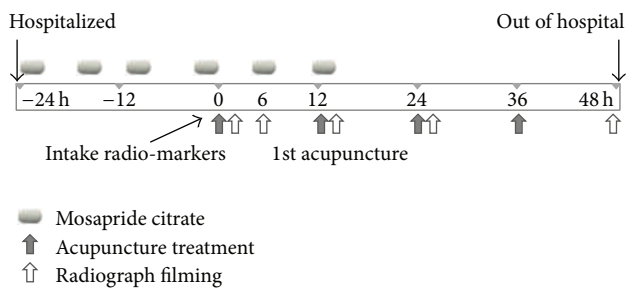

FIGURE 2: Study scheme. Subjects were administered 15 mg of mosapride citrate per day (3 treatments of 5 mg) for 2 days starting 24 hours before the first acupuncture treatment. Immediately after the administration of radio markers, acupuncture treatment was conducted at 12-hour intervals. Gastrointestinal motility was measured via radiography immediately after the first acupuncture treatment and at 6, 12, 24, and 48 hours thereafter.

and outside the body was scored as 1, 2, 3, 4, 5, and 6, respectively (Figure 3(b)). The total scores of GI motility were calculated according to the distributions of 20 radio markers

at each time point. One specialist in diagnostic radiology, who was blinded to the randomization, analyzed the radiographs.

2.5. *Statistical Analysis.* All data were entered into a data sheet twice and reviewed to ensure accuracy. A per-protocol (PP) analysis was conducted. All data were summarized as the mean ± standard deviation for continuous data and as the frequency (%) for dichotomous data. A Student’s *t*-test was used to analyze the differences of the mean change in scores between the two groups at 6, 12, 24, and 48 hours. Statistical analysis was performed using the SAS statistical package (v.9.1; SAS institute Inc., Cary, NC, USA), and the level of significance was established at  $P = 0.05$ .

### 3. Results

3.1. *Effects on Gastrointestinal Motility.* Along with the time points of radiography, both the RA and SA groups showed an increase in EWS values, thereby indicating the gradual passage of radio markers from the stomach and small intestine into the rectum and outside of the body. Almost no

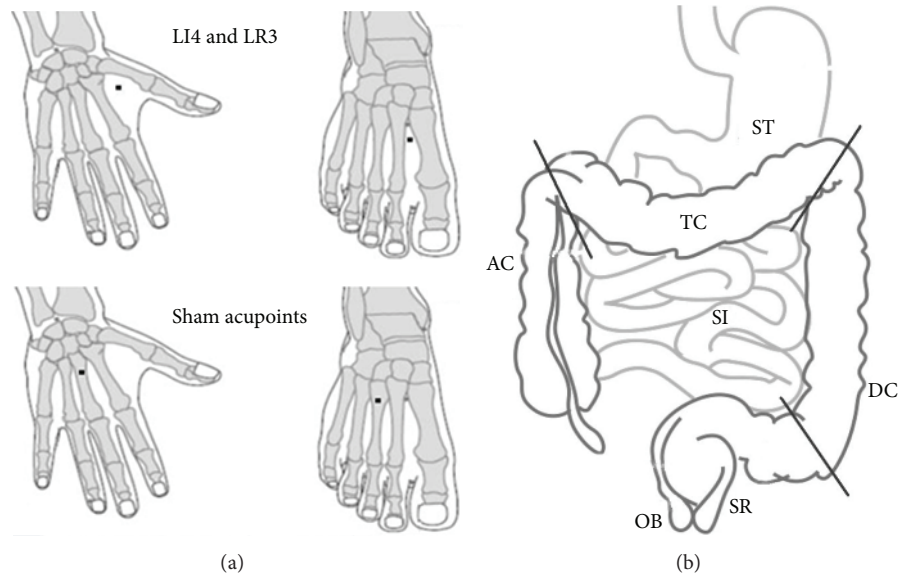

FIGURE 3: Acupoints and illustration of the alimentary canal. (a) Siguan acupoints (bilateral LI4 and LR3) and sham acupoints. The sham acupoints were applied to the nonacupoints 2-3 cm laterally from LI4 and LR3 on both hands and feet. (b) A simple illustration of the alimentary canal. Abbreviations: ST, stomach; SI, small intestine; AC, ascending colon; TC, transverse colon; DC, descending colon; SR, sigmoid/rectum; and OB, outside body.

radioactivity was observed in the radiographs of either the RA or SA groups after 48 hours of radio markers administration, which indicates that most radio markers had already been defecated. For all radiographies, the EWS values were lower in the RA group compared with the SA group. In particular, the differences in the value changes between the two groups were significant at 24 hours after the first acupuncture treatment ( $P < 0.05$ ). At 6, 12, and 48 hours after radio markers intake, no significant difference was observed in GI motility ( $P > 0.05$ , Table 2).

**3.2. Effect on Defecation Frequency.** Because of the relationship between intestinal movement and defecation, the number of times each subject defecated was accurately recorded before and during the trial. The mean frequency of daily defecations for all subjects was  $0.9 \pm 0.4$  before the trial. The administration of mosapride citrate slightly increased the frequency of daily defecations by approximately 1.3 times. No significant change in the average number of defecations between the two groups was observed (Table 3).

**3.3. Successful Completion Rates and Adverse Effects.** Two subjects withdrew from the study due to personal reasons after the first session. Nineteen subjects completed the two sessions of procedures. Two subjects reported severe diarrhea during the first session (RA group) and the second session (SA group); therefore, these individuals were excluded from the final data analysis. No acupuncture-associated adverse events or abnormal blood pressure measurements were reported during the two sessions of the trial.

## 4. Discussion

Acupuncture originated in east-Asia during ancient times and is now used for the treatment of various conditions worldwide [13]. Numerous studies have demonstrated the therapeutic effects of acupuncture for a variety of conditions, such as chronic pain (back and neck pain, osteoarthritis, chronic headache, and shoulder pain) [14], osteoarthritis [15–17], dental pain [18] as well as nausea, and vomiting [19, 20]. Moreover, acupuncture is a relatively safe treatment, although minor adverse events, including feelings of faintness and syncope, have been rarely observed following acupuncture treatment [21, 22].

Siguan acupuncture has been used for various conditions, including respiratory failure [23], chronic fatigue syndrome [24], primary dysmenorrheal [24], and particularly disorders of the digestive system [2, 3]. Distortion of GI motility can lead to GI symptoms such as abdominal pain, constipation, and diarrhea. Siguan acupuncture is also believed to be partially associated with the autonomic nervous system. In animal study using rats, acupuncture stimulation to the acupoints on forelimbs and hindlimbs affected GI motility via modulation of vagus nerves and sympathetic nerves [25]. Therefore, the therapeutic mechanisms of Siguan acupuncture on the GI motility are thought to modulate GI motility.

Based on our series of studies, we investigated the hypothesis that Siguan acupuncture acts by modulating GI motility differently depending on the status of its activities. A prior study was conducted on normal adults for whom no effect on GI motility was observed with Siguan acupuncture [10], while Siguan acupuncture improved suppressed GI motility with loperamide [11]. In the current study, we investigated



TABLE 2: Change in exponential weighted score at four different time points.

Time point	Group	Exponential weighted score	<i>t</i> value	<i>P</i> value	95% confidence interval
6 h	RA group	12.8 ± 10.9	0.458	0.653	(7.6, 18.0)
	SA group	14.1 ± 9.80			(9.4, 18.8)
12 h	RA group	43.5 ± 16.2	1.112	0.282	(35.8, 51.2)
	SA group	49.6 ± 22.8			(38.7, 60.4)
24 h	RA group	66.9 ± 20.0	2.220	0.041*	(57.5, 76.4)
	SA group	76.1 ± 17.1			(68.0, 84.3)
48 h	RA group	92.1 ± 13.5	1.258	0.226	(85.7, 98.5)
	SA group	96.1 ± 7.70			(92.4, 99.7)

The results show altered values of the weighted score for radio-markers movement in the RA and SA groups at four different time points compared with time 0. The results are expressed as the mean ± standard deviation.

\*Represents a significant difference between the two groups with  $P < 0.05$  as assessed via Student's *t*-test.

TABLE 3: Frequency of defecation during the treatments.

Time point	Group	Frequency of defecation (times/day)	<i>t</i> value	<i>P</i> value	95% confidence interval
Before trial	Total subjects	0.9 ± 0.4	—	—	—
24 h	RA group	1.3 ± 0.9	−0.477	0.637	(0.9, 1.7)
	SA group	1.1 ± 1.3			(0.5, 1.7)
48 h	RA group	1.3 ± 0.9	0.000	1.000	(0.9, 1.7)
	SA group	1.3 ± 0.9			(0.9, 1.7)

The results show the defecation frequency of the RA and SA groups at three different time points. No statistical significance was observed between the two groups.

whether Siguan acupuncture suppresses the activity of GI motility under GI hypermotility conditions.

GI motility varies between individuals [26] and is closely associated with food [27], stress [28], and psychological states such as anxiety and depression [29]. Accordingly, this study was conducted with a crossover design to overcome the individual differences of basal levels of transit time for the entire gut. Additionally, all the subjects were hospitalized to ensure that they would have the same meals and life style patterns throughout the two sessions. The GI motility is easily affected by menstruation-related emotion and pain; therefore, we recruited only a male in this study. To generate an excessive condition of GI motility, all subjects were administered mosapride citrate for 2 days. Mosapride citrate is a serotonin 5-hydroxytryptan-4 (5-HT<sub>4</sub>) receptor agonist that enhances the gastric accommodation reflex and antral contractions, and increases gastric motility and gastric emptying [30–32]. Comparing the average frequency of defecation (0.9 ± 0.4 times per day), the defecation frequency was increased approximately 1.3 times.

To evaluate the overall effects of Siguan acupuncture, we examined the distribution of 20 radio markers assigned a weighted score according to the passage from the stomach at 4 time points. As expected, the EWS scores increased with time following the intake of radio markers. The pattern of GI motility was generally lower in the RA group than in the SA group throughout the experimental period. The greatest difference was observed at 24 hours following the first

acupuncture treatment, which was statistically significant ( $P < 0.05$ ). At 6, 12, and 48 hours after the administration of radio markers, no significant difference was observed in GI motility ( $P > 0.05$ ). These results show that Siguan acupuncture lowers GI motility under conditions of a mosapride citrate-induced acceleration of GI motility. And to present the statistical significance especially at 24 hours would be associated with that radio-markers' distribution had passed GI track by moderated distance where is optimal compared with other time-points. This finding supports the clinical observations that Siguan acupuncture displays therapeutic effects for various disorders, including diarrhea and constipation. One study showed that the change in GI motility was observed at a stimulation level of acupuncture exceeding the threshold for A $\delta$  and/or C afferent fiber activation [25]. Therefore, we expect that a stronger stimulation at Siguan, such as electroacupuncture, would induce a more significant modification of GI motility.

Two participants withdrew consent after the first session, and two participants were excluded from the data analysis because they tested negative for radio markers due to severe diarrhea. The subjects who completed the two sessions ( $n = 17$ ) were included in the statistical analysis. Although we adapted a crossover design, this study has several limitations. First, the assessment of GI motility is restraint, as the EWS score for both groups reaches the maximum score when total radio markers pass outside of the body. Second, this study was conducted on an artificially induced pathology, which

may vary in the real status. In fact, GI hypermotility was lower than we expected by 1.5 times, and two participants had diarrhea.

The main purpose of acupuncture is to balance and normalize body functions in traditional Meridian theory. Our serial studies strongly suggest that Siguan acupuncture tends to normalize the abnormal state of GI motility. We propose that our results are evidence for the general mechanism of acupuncture action. Further studies are required to confirm the effects of Siguan acupuncture in patients with various states of GI motility, such as constipation, diarrhea, and irritable bowel syndrome.

## 5. Conclusions

This study partially evidenced that Siguan acupuncture can modulate GI motility a therapeutic manner under mosapride citrate-induced excessive condition.

## Conflict of Interests

All the authors declare that they have no conflict of interests.

## Acknowledgments

This study was supported by a grant from the “Development of Acupuncture and Moxibustion Health Technology,” Korea Institute of Oriental Medicine, Republic of Korea (KI3011).

## References

- [1] M. T. Cabýoglu, N. Ergene, and U. Tan, “The mechanism of acupuncture and clinical applications,” *International Journal of Neuroscience*, vol. 116, no. 2, pp. 115–125, 2006.
- [2] W. B. Fu, “Clinical application of the Siguan (four-gate) points with case studies,” *American Journal of Acupuncture*, vol. 19, no. 2, pp. 121–124, 1991.
- [3] J. Y. Park, M. S. Kim, J. C. Jeon et al., “Comparative study of sosang (LU11)-eunbaek (SP1) bloodletting and sa-kwan (LI4 and LR3) acupuncture on acute dyspepsia,” *The Journal of Korean Acupuncture and Moxibustion Society*, vol. 27, no. 1, pp. 129–135, 2010.
- [4] C. H. Yang, B. H. Lee, and S. H. Sohn, “A possible mechanism underlying the effectiveness of acupuncture in the treatment of drug addiction,” *Evidence-Based Complementary and Alternative Medicine*, vol. 5, no. 3, pp. 257–266, 2008.
- [5] R. J. Zhao, S. S. Yoon, B. H. Lee et al., “Acupuncture normalizes the release of accumbal dopamine during the withdrawal period and after the ethanol challenge in chronic ethanol-treated rats,” *Neuroscience Letters*, vol. 395, no. 1, pp. 28–32, 2006.
- [6] J. P. Plummer, “Acupuncture and homeostasis: physiological, physical (postural) and psychological,” *The American Journal of Chinese Medicine*, vol. 9, no. 1, pp. 1–14, 1981.
- [7] Y. S. Dong and S. L. Xing, “Effect of acupuncture needle-retention duration at Baihui (GV 20) and sishencong (EX-HN 1) on blood pressure in hypertension patients,” *Acupuncture Research*, vol. 37, no. 3, pp. 233–236, 2012.
- [8] Y. Lan and W. Meng, “Clinical observation of needling point Baihui for 180 cases of hypotension,” *Shanghai Journal of Acupuncture and Moxibustion*, vol. 17, no. 4, p. 8, 1998.
- [9] Z. Li, C. Wang, A. F. T. Mak, and D. H. K. Chow, “Effects of acupuncture on heart rate variability in normal subjects under fatigue and non-fatigue state,” *European Journal of Applied Physiology*, vol. 94, no. 5–6, pp. 633–640, 2005.
- [10] Y. K. Yim, W. C. Kang, J. H. Cho et al., “Crossover clinical trial to determine the effect of manual acupuncture at Siguan points (Bilateral LI4 and LR3) on intestinal motility in healthy subjects,” *The American Journal of Chinese Medicine*, vol. 35, no. 2, pp. 209–218, 2007.
- [11] D. S. Oh, S. Y. Jung, A. R. Kim et al., “A crossover clinical trial to determine the effect of Siguan (four gates) points on gastrointestinal motility suppressed by loperamide administration,” *The Journal of Korean Oriental Medicine*, vol. 29, no. 1, pp. 1–6, 2008.
- [12] A. E. Bharucha, M. Camilleri, S. Haydock et al., “Effects of a serotonin 5-HT<sub>4</sub> receptor antagonist SB-207266 on gastrointestinal motor and sensory function in humans,” *Gut*, vol. 47, no. 5, pp. 667–674, 2000.
- [13] A. Vickers and C. Zollman, “ABC of complementary medicine: acupuncture,” *British Medical Journal*, vol. 319, no. 7215, pp. 973–976, 1999.
- [14] A. J. Vickers, A. M. Cronin, A. C. Maschino et al., “Acupuncture for chronic pain: individual patient data meta-analysis,” *Archives of Internal Medicine*, vol. 172, no. 19, pp. 1444–1453, 2012.
- [15] Y. D. Kwon, M. H. Pittler, and E. Ernst, “Acupuncture for peripheral joint osteoarthritis: a systematic review and meta-analysis,” *Rheumatology*, vol. 45, no. 11, pp. 1331–1337, 2006.
- [16] E. Manheimer, K. Cheng, K. Linde et al., “Acupuncture for peripheral joint osteoarthritis,” *Cochrane Database System Review*, vol. 20, no. 1, Article ID CD001977, 2010.
- [17] A. White, N. E. Foster, M. Cummings, and P. Barlas, “Acupuncture treatment for chronic knee pain: a systematic review,” *Rheumatology*, vol. 46, no. 3, pp. 384–390, 2007.
- [18] E. Ernst and M. H. Pittler, “The effectiveness of acupuncture in treating acute dental pain: a systematic review,” *British Dental Journal*, vol. 184, no. 9, pp. 443–447, 1998.
- [19] A. Lee and L. T. Y. Fan, “Stimulation of the wrist acupuncture point P6 for preventing postoperative nausea and vomiting,” *Cochrane Database System Review*, vol. 15, no. 2, Article ID CD003281, 2009.
- [20] J. M. Ezzo, M. A. Richardson, A. Vickers et al., “Acupuncture-point stimulation for chemotherapy-induced nausea or vomiting,” *Cochrane Database System Review*, vol. 2, Article ID CD002285, 2006.
- [21] E. Ernst and A. R. White, “Prospective studies of the safety of acupuncture: a systematic review,” *The American Journal of Medicine*, vol. 110, no. 6, pp. 481–485, 2001.
- [22] L. Lao, G. R. Hamilton, J. Fu, and B. M. Berman, “Is acupuncture safe? A systematic review of case reports,” *Alternative Therapies in Health and Medicine*, vol. 9, no. 1, pp. 72–83, 2003.
- [23] Y. Li and W. C. Zhang, “Effects of acupuncture in Siguan points on man-machine counteraction in respiratory failure patients during mechanical ventilation,” *Chinese Journal of Integrated Traditional and Western Medicine*, vol. 26, no. 10, pp. 930–932, 2006.
- [24] J. J. Wang, H. Meng, C. B. Cui, Y. J. Song, X. H. Wang, and Z. C. Wu, “On the important role of Siguan points in treatment of chronic fatigue syndrome,” *Chinese Acupuncture & Moxibustion*, vol. 26, no. 2, pp. 116–119, 2006.
- [25] Y. Q. Li, B. Zhu, P. J. Rong, H. Ben, and Y. H. Li, “Neural mechanism of acupuncture-modulated gastric motility,” *World Journal of Gastroenterology*, vol. 13, no. 5, pp. 709–716, 2007.

- [26] L. P. Degen and S. F. Phillips, "Variability of gastrointestinal transit in healthy women and men," *Gut*, vol. 39, no. 2, pp. 299–305, 1996.
- [27] S. S. Davis, J. G. Hardy, M. J. Taylor et al., "The effect of food on the gastrointestinal transit of pellets and an osmotic device (Osmet)," *International Journal of Pharmaceutics*, vol. 21, no. 3, pp. 331–340, 1984.
- [28] Y. Taché, V. Martinez, M. Million, and L. Wang, "III. Stress-related alterations of gut motor function: role of brain corticotropin-releasing factor receptors," *American Journal of Physiology*, vol. 280, no. 2, pp. G173–G177, 2001.
- [29] D. A. Gorard, J. E. Gomborone, G. W. Libby, and M. J. G. Farthing, "Intestinal transit in anxiety and depression," *Gut*, vol. 39, no. 4, pp. 551–555, 1996.
- [30] H. Kusunoki, K. Haruma, J. Hata et al., "Efficacy of mosapride citrate in proximal gastric accommodation and gastrointestinal motility in healthy volunteers: a double-blind placebo-controlled ultrasonographic study," *Journal of Gastroenterology*, vol. 45, no. 12, pp. 1228–1234, 2010.
- [31] J. Endo, M. Nomura, S. Morishita et al., "Influence of mosapride citrate on gastric motility and autonomic nervous function: evaluation by spectral analyses of heart rate and blood pressure variabilities, and by electrogastrography," *Journal of Gastroenterology*, vol. 37, no. 11, pp. 888–895, 2002.
- [32] M. Sakashita, T. Yamaguchi, H. Miyazaki et al., "Pharmacokinetics of the gastrokinetic agent mosapride citrate after single and multiple oral administrations in healthy subjects," *Arzneimittelforschung*, vol. 43, no. 8, pp. 867–872, 1993.

## Research Article

# Electroacupuncture at Zusanli (ST36) Prevents Intestinal Barrier and Remote Organ Dysfunction following Gut Ischemia through Activating the Cholinergic Anti-Inflammatory-Dependent Mechanism

Sen Hu,<sup>1</sup> Ming-Hua Du,<sup>1,2</sup> Hong-Min Luo,<sup>1,2</sup> Huan Wang,<sup>1,2</sup> Yi Lv,<sup>1</sup> Li Ma,<sup>1</sup> Zhi-Long Lin,<sup>1</sup> Xian Shi,<sup>3</sup> Ingrid Gaischek,<sup>4</sup> Lu Wang,<sup>3,4</sup> and Gerhard Litscher<sup>3,4</sup>

<sup>1</sup> Research Laboratory of Shock and Multiple Organ Dysfunction, Burns Institute, First Hospital Affiliated to the PLA General Hospital, Beijing 100048, China

<sup>2</sup> Medical School of Chinese PLA, Beijing 100853, China

<sup>3</sup> Department of Acupuncture and Moxibustion, Chinese People's Liberation Army General Hospital, No. 28 Fu-Xing Road, Beijing 100853, China

<sup>4</sup> Stronach Research Unit for Complementary and Integrative Laser Medicine, TCM Research Center Graz, Research Unit of Biomedical Engineering in Anesthesia and Intensive Care Medicine, Medical University of Graz, Auenbruggerplatz 29, 8036 Graz, Austria

Correspondence should be addressed to Xian Shi; 301sx@live.cn and Gerhard Litscher; gerhard.litscher@medunigraz.at

Received 11 January 2013; Accepted 18 March 2013

Academic Editor: Weibo Zhang

Copyright © 2013 Sen Hu et al. This is an open access article distributed under the Creative Commons Attribution License, which permits unrestricted use, distribution, and reproduction in any medium, provided the original work is properly cited.

This study investigated the protective effect and mechanism of electroacupuncture at ST36 points on the intestinal barrier dysfunction and remote organ injury after intestinal ischemia and reperfusion injury in rats. Rats were subjected to gut ischemia for 30 min, and then received electroacupuncture for 30 min with or without abdominal vagotomy or intraperitoneal administration of cholinergic  $\alpha 7$  nicotinic acetylcholine receptor ( $\alpha 7$ nAChR) inhibitor. Then we compared its effects with electroacupuncture at nonchannel points, vagal nerve stimulation, or intraperitoneal administration of cholinergic agonist. Cytokine levels in plasma and tissue of intestine, lung, and liver were assessed 60 min after reperfusion. Intestinal barrier injury was detected by histology, gut injury score, the permeability to 4 kDa FITC-dextran, and changes in tight junction protein ZO-1 using immunofluorescence and Western blot. Electroacupuncture significantly lowered the levels of tumor necrosis factor- $\alpha$  and interleukin-8 in plasma and organ tissues, decreased intestinal permeability to FITC-dextran, and prevented changes in ZO-1 protein expression and localization. However, abdominal vagotomy or intraperitoneal administration of cholinergic  $\alpha 7$ nAChR inhibitor reversed these effects of electroacupuncture. These findings suggest that electroacupuncture attenuates the systemic inflammatory response through protection of intestinal barrier integrity after intestinal ischemia injury in the presence of an intact vagus nerve.

## 1. Introduction

Intestine ischemia and reperfusion (iI/R) injury are usually secondary to a variety of diseases, such as multiple trauma, severe burn, various forms of shock, intra-abdominal sepsis, surgical operation, and inflammatory bowel disease. Gut I/R injury may result in mucosal epithelial cell damage, loss of basement membrane integrity and barrier function, which promote bacterial translocation and the local production of cytokines. Then bacteria and its endotoxin shift to circulation

and remote organs such as lung and liver, contributing to the subsequent local and systemic inflammation, which may lead to systemic inflammation response syndrome (SIRS), multiple organ dysfunction syndrome (MODS), and possibly, death [1, 2]. This evidence suggest that the loss of epithelial cell integrity and barrier function of intestine may very well be a source or promoter for the systemic inflammatory process and MODS. Thus, interventions to prevent the gut epithelial barrier breakdown and to attenuate the local and secondary distant organ inflammatory response would be

critical in preventing SIRS or MODS and improving patients' outcome [3, 4]. However, at present, there is still a lack of effective drugs or interventions to protect the gut epithelial barrier. Recent studies showed that electrical stimulation of the vagus nerve could protect intestinal barrier and alleviate inflammatory injury in intestine and remote organs of animals following burn injury by activation of the cholinergic anti-inflammatory pathway [5–8]. However, it is still difficult to apply electrical stimulation to the vagus nerve in clinical practice due to complicated manipulation and untoward side effects, including serious tissue injury.

Acupuncture as one of the therapeutic maneuvers in traditional Chinese medicine (TCM) has been applied in clinics for thousands of years, and it has been found to have a bidirectional neuron-endocrine-immune system regulating effect; also, it antagonizes systemic inflammatory response with no side effects. Studies also showed that acupuncture at Zusanli (ST36) points, which was found to be related to the parasympathetic system, could attenuate inflammatory response and prompt gastrointestinal function [9–11].

Since the effect of acupuncture at ST36 is similar to that of activating the vagus nerve [9, 10, 12], we hypothesize that acupuncture at bilateral ST36 might exert a protective effect on intestinal barrier injury through activation of the vagus nerve pathway and its cholinergic receptor. Therefore, the objectives of our present study are to investigate whether electroacupuncture at ST36 could attenuate the release of tumor necrosis factor- $\alpha$  (TNF- $\alpha$ ) and interleukin-8 (IL-8) in local intestine, alleviate the injury of intestinal villus, reduce the permeability of the intestinal mucosa, regulate the integrity of intestinal tight junctions, prevent degradation of intestinal ZO-1 expression, thus reduce the levels of TNF- $\alpha$  and IL-8 in lung, liver, and serum, protect intestinal barrier and remote organ functions. Moreover, we wanted to explore the relationship between electroacupuncture, vagus nerve and  $\alpha 7$  nicotinic acetylcholine receptor ( $\alpha 7$ nAChR), and the exact mechanism underlying in electroacupuncture ST36 protection of gut barrier and remote organ function.

## 2. Materials and Methods

**2.1. Animals.** Seventy-two male Sprague-Dawley rats, aged 12 weeks, weighing  $250 \pm 20$  g (purchased from the experimental animal farm of Chinese Peking Union Medical College, Beijing), were used for the experiments. Rats were acclimatized for a while in mesh cages in a temperature-controlled room with a 12 h light-dark cycle in the animal quarter of our laboratory and fasted overnight but allowed free access to water until 4 hours before surgery. All research protocols were approved by the Committee of Scientific Research of the First Hospital Affiliated to General Hospital of PLA, China. The experiment was conducted in compliance with the Guide for Care and Use of Laboratory Animals of National Research Council, China.

**2.2. Intestine Ischemia Model.** Rats were anesthetized with 2% isoflurane inhalation (Yeeran Technology Limited, Beijing, China), and the ventral neck and abdomen were shaved and

washed with 10% povidone iodine. The rats were secured onto a heating pad to maintain appropriate body temperature during anesthesia. A right cervical neck incision was performed and the right cervical vagus nerve exposed. A 2 cm upper-midline laparotomy incision was performed to identify gastroesophageal junction and expose the dorsal and ventral vagus nerve on the distal esophagus with a Phenix XLT165-LB stereomicroscope (Phenix Optical Instrument Group Company, Jiangxi Province, China). Then, a microvascular clip was placed across the superior mesenteric artery (SMA) for 30 min. After that, the microvascular clip was removed to allow reperfusion for 60 min, and the animals were randomly assigned to various groups [13].

**2.3. Animal Grouping and Treatments.** As illustrated in Table 1, all the animals underwent the same surgical procedure and ischemia-reperfusion injury, and then the rats were randomly assigned to six groups (see Table 1) with 12 rats each and subjected to different treatments. Animals in the ischemia-reperfusion group (IR) underwent electroacupuncture at nonchannel points (SEA) which were located at the bilateral capitulum fibulae apart from outside the fibulae, with the outside condyle center point to about 1 cm place immediately after the ischemia [14]. Those in the electroacupuncture group (EA) underwent electroacupuncture at ST36 points, located at the posterior and lateral side of the knee joint, 5 mm below capitulum fibulae [14], immediately after the ischemia. Those in the vagotomy group (VX) underwent vagotomy of the dorsal and ventral vagus nerve on the distal esophagus prior to electroacupuncture at ST36 points immediately after the ischemia. Those in the  $\alpha$ -bungarotoxin group ( $\alpha$ -BGT) underwent intraperitoneal administration of  $\alpha$ -bungarotoxin ( $1 \mu\text{g}/\text{kg}$ , Sigma; an antagonist of  $\alpha 7$  subunit of cholinergic nicotinic receptor) prior to electroacupuncture at ST36 points immediately after the ischemia [15]. Those in the vagus nerve stimulation group (VNS) underwent electrical stimulation at the right cervical vagus nerve, and those in the PNU282987 group (PNU) underwent intraperitoneal administration of PNU282987 ( $1\text{--}10 \text{ mg}/\text{kg}$ , IP, Sigma; an  $\alpha 7$ nAChR agonist) immediately after the ischemia.

**2.4. Electroacupuncture at Zusanli (ST36).** Both hind limbs were shaved and the skin was disinfected. ST36 acupuncture point was punctured with a depth of 7 mm, and then the needle was connected with an electroacupuncture apparatus (HANS, LH202H). The stimulation was performed for 30 min using an electric current with the intensity of 2 mA and 2–100 Hz. In the EA group, electroacupuncture at ST36 points was applied immediately after ischemia. In the VX group, surgical abdominal vagotomy was performed immediately prior to reperfusion and then electroacupuncture at ST36 points. In the  $\alpha$ -BGT group, electroacupuncture was applied immediately after intraperitoneal injection of  $\alpha$ -bungarotoxin. Rats in the I/R group were subjected to EA at nonchannel points as previously described.

**2.5. Vagus Nerve Stimulation.** Following induction of general anesthesia with inhaled isoflurane and prior to ischemia

TABLE 1: Groups and treatments.

Groups	Treatments							
	I/R	SEA	EA	Vagus nerve stimulation	PNU282987	Vagotomy	$\alpha$ -BGT	
IR	+	+	-	-	-	-	-	
EA	+	-	+	-	-	-	-	
VNS	+	-	-	+	-	-	-	
PNU	+	-	-	-	+	-	-	
VX	+	-	+	-	-	+	-	
$\alpha$ -BGT	+	-	+	-	-	-	+	

Groups: IR, electroacupuncture at nonchannel points (SEA); EA, electroacupuncture at ST36 acupoints; VNS, vagus nerve stimulation; PNU, PNU282987; VX, vagotomy and electroacupuncture at ST36 points;  $\alpha$ -BGT,  $\alpha$ -bungarotoxin and electroacupuncture at ST36 points.

insult, a right cervical neck incision was performed and the right cervical vagus nerve was exposed. An upper-midline laparotomy incision was performed; the gastroesophageal junction was identified; the dorsal and ventral vagus nerve were visualized; both branches of the vagus nerve were identified and divided on the distal esophagus with a stereomicroscope. Vagal nerve stimulation of the right cervical vagus was performed using a biological function experimental system (BL-420F, Chengdu Taimeng Science and Technology Co., Ltd., China) set at 2 mA, 1 Hz for 20 minutes immediately after ischemia in the VNS group. Rats in the VX group underwent right cervical and upper-midline laparotomy incision and vagotomy of the dorsal and ventral vagus nerve before electroacupuncture at ST36 but did not receive vagal nerve stimulation; all other groups underwent right cervical and upper midline laparotomy incision and exposure of the vagus nerve but did not receive vagal nerve stimulation or vagotomy.

**2.6. Samples of Blood, Intestine, Lung, and Liver Tissues.** Rats were anesthetized with 2% isoflurane inhalation and sacrificed by abdominal aorta exsanguination at 60 min after reperfusion. Systemic blood was drawn by abdominal aorta puncture and placed in heparinized Eppendorf tubes on ice. Plasma was obtained by centrifuging the blood at 10,000 g for 10 minutes at 4°C. Segments of distal small intestine, lung, and liver were harvested and immediately homogenized on ice with a 1 mL denaturing lysis buffer or nondenaturing lysis buffer for Western blot or ELISA. The homogenate was then centrifuged at 10,000 g for 10 min at 4°C. Aliquots of the supernatants of plasma and tissue were stored at -80°C until use. Segments of intestine, lung, and liver were also harvested and snap frozen in liquid nitrogen before storage at -80°C for detection. Segments of intestine were also harvested and fixed in 4% paraformaldehyde for histologic evaluation and immunofluorescence.

**2.7. Detection of TNF- $\alpha$  and IL-8 Levels in Intestine, Lung, Liver, and Plasma.** TNF- $\alpha$  and IL-8 levels in the plasma, intestine, lung, and liver were assessed using commercially available ELISA kits in accordance with the protocol provided by the manufacturer (Nanjing Jiancheng Corp., China). Supernatants were transferred into fresh tubes for the evaluation. Briefly, after adding 50  $\mu$ L of assay buffer,

50  $\mu$ L of samples or standard concentration for TNF- $\alpha$  or IL-8 were incubated with 50  $\mu$ L of diluted Biotin Conjugate for 2 hours at room temperature. After 3 washes, the plates were incubated with Streptavidin-HRP for 1 hour at room temperature. After 3 washes, TMB substrate solution was added to the plates for 15 minutes, and the reaction was stopped with stop solution. The absorbance rate was read at 450 nm. The concentrations of the samples were calculated according to the standard curve. TNF- $\alpha$  and IL-8 levels in the plasma were expressed as pg/ml. Intestine, lung, and liver TNF- $\alpha$  and IL-8 levels were expressed as picograms per milligram of protein.

**2.8. Histopathologic Score.** Segments of the distal ileum were fixed in 10% buffered formalin, embedded in paraffin, and sectioned. Hematoxylin and eosin staining of the intestine was performed. Sections were viewed via light microscopy and reviewed by a pathologist who was blinded to the experimental groups. Three randomly selected fields from each specimen were graded using a scoring system that characterized gut injury on a scale from 0 to 4 where 0 is normal, no damage; 1 is mild, focal epithelial edema; 2 is moderate, diffuse swelling, and necrosis of the villi; 3 is severe, diffuse pathology of the villi with evidence of neutrophil infiltration in the submucosa; and 4 is major, widespread injury with massive neutrophil infiltration and hemorrhage as previously described [16].

**2.9. Intestinal Epithelial Permeability.** An *in vivo* intestinal permeability assay was performed to assess intestinal barrier function. 60 min after reperfusion, animals were anesthetized with inhaled isoflurane. A midline laparotomy incision was performed, and a 5 cm segment of distal ileum was isolated between silk ties. A solution of 500  $\mu$ L containing 4-kDa FITC-dextran (25 mg/mL, Sigma, St. Louis, USA) diluted in phosphate-buffered saline (PBS) was injected into the lumen of the isolated segment of intestine. The bowel was returned to the abdominal cavity and the abdomen was closed. Animals were maintained lightly under general anesthesia for 30 minutes, at which time systemic blood was drawn by abdominal aorta puncture and placed in heparinized Eppendorf tubes on ice. Plasma was obtained by centrifuging the blood at 10,000 g for 10 minutes at -4°C. Plasma fluorescence was measured in

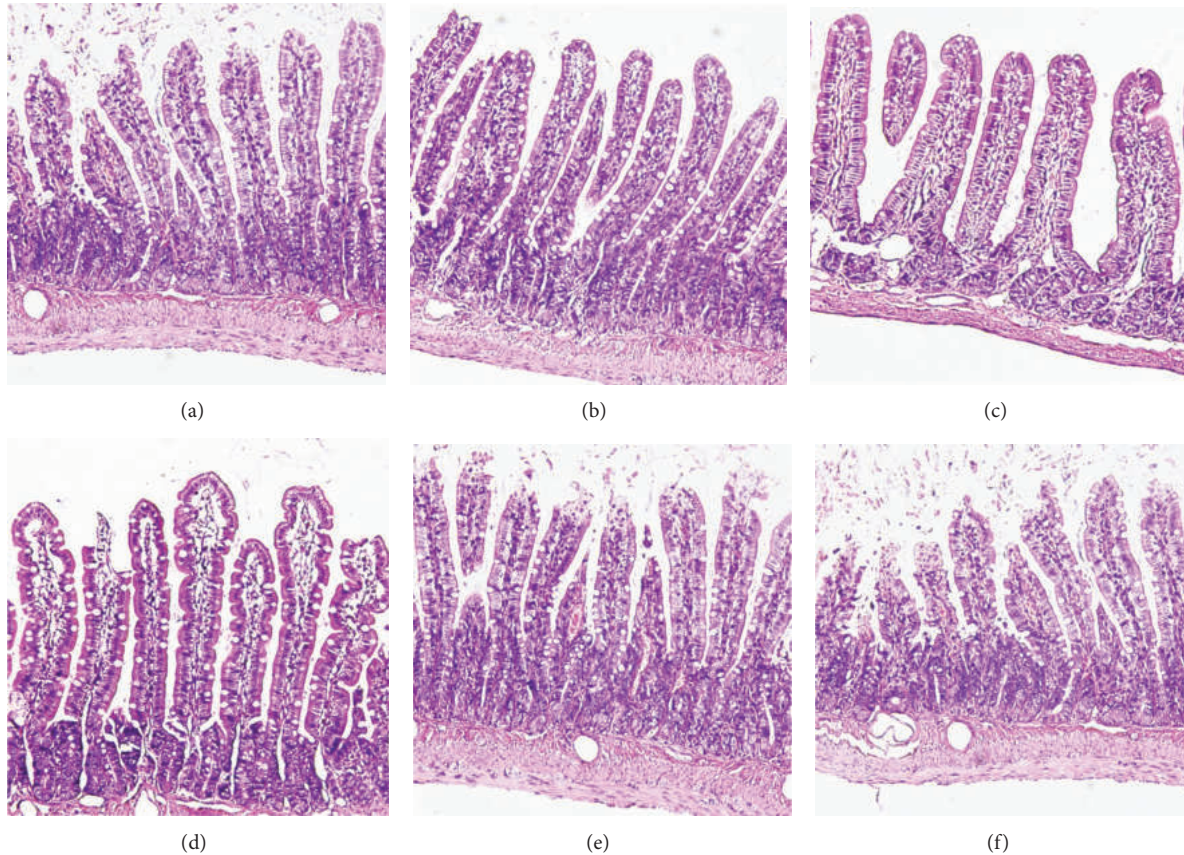

FIGURE 1: Intestinal histology at 60 min after reperfusion. Electroacupuncture at ST36 protects against intestinal injury after I/R equally as VNS and PNU282987; whereas electroacupuncture at nonchannel points and electroacupuncture at ST36 after abdominal vagotomy or administration of  $\alpha$ -BGT eliminates such protection. Sections of the distal ileum were harvested 60 min after reperfusion ( $n$  is 12 animals per group) and stained with hematoxylin and eosin. All images are taken at  $\times 200$  magnification with black bar =  $5 \mu\text{m}$ . (a) animals in IR group, (b) animals in EA group, (c) animals in VNS group, (d) animals in PNU group, (e) animals in VX group, and (f) animals in  $\alpha$ -BGT group.

a fluorescence spectrophotometer (Synergy2; BioTek Multi-Detection Microplate reader, USA) and compared with a standard curve of known concentrations of FITC-dextran diluted in rat plasma.

**2.10. Immunofluorescence.** After deparaffinization, the intestine sections were rehydrated and incubated in citrate buffer (Zhongshan Jinqiao Biotechnology Co., Ltd., Beijing, China) for heat-induced antigen retrieval. After three washes with PBS, sections were incubated with 3% BSA (Zhongshan Jinqiao Biotechnology Co., Ltd., Beijing, China) for 30 minutes to block nonspecific binding sites. The sections were then incubated in the ZO-1 antibody (1:100; Life Technologies, Gaithersburg, USA) at  $4^\circ\text{C}$  overnight. The following day, after washing with PBS three times, they were treated with Alexa Fluor 488 secondary goat anti-rabbit antibody in 1% BSA for 1 hour at room temperature. Prolong Fade (Antifade Mounting Medium, Beyotime Institute of Biotechnology) was added on placement of cover slips. Images were viewed using the Olympus fluorescence microscope (BX51-DP71) with exposure-matched settings.

**2.11. ZO-1 Expression.** The harvested gut tissues were placed in 1 mL of lysis buffer (50 mM Tris-HCl, pH 7.4; 150 mM NaCl; 1% NP-40; 0.1% SDS), then homogenized and centrifuged at 12,000 g for 10 minutes. Following centrifugation, the supernatant was collected and analyzed for protein concentration. Protein concentrations were determined using a protein assay kit (Applygen Technologies Inc. Beijing, China). Total protein (100  $\mu\text{g}$ ) was loaded onto a sodium dodecyl sulfate-polyacrylamide gel (SDS-PAGE gel) and run at 120 volts for 2 hours. After electrophoresis, the protein was transferred to a polyvinylidene difluoride membrane (PVDF; Applygen Technologies Inc. Beijing, China) and blocked for 2 hours in TBST (50 mM Tris; 150 mM NaCl; 0.05% Tween 20) containing 5% milk (Applygen Technologies Inc. Beijing, China). The membrane was then incubated with the primary antibodies against GAPDH (1:5000; Zhongshan Jinqiao Biotechnology Co., Ltd., Beijing, China), and ZO-1 (1:500; Life Technologies, Gaithersburg, USA) at  $4^\circ\text{C}$  overnight. After 3 washes in TBST, the membrane was then incubated with corresponding secondary antibodies conjugated to horseradish peroxidase at room temperature

TABLE 2: The effects of EA at ST36 on the levels of TNF- $\alpha$  in plasma, intestine, lung, and liver in rats with I/R injury (mean  $\pm$  SD,  $n = 12$ ).

Groups	TNF- $\alpha$			
	Intestine	Lung	Liver	Plasma
IR	8.4 $\pm$ 1.1	6.6 $\pm$ 0.85	4.3 $\pm$ 0.79	18.63 $\pm$ 3.1
EA	3.9 $\pm$ 0.65 <sup>#</sup>	2.5 $\pm$ 0.5 <sup>#</sup>	1.1 $\pm$ 0.4 <sup>#</sup>	12.3 $\pm$ 1.1 <sup>#</sup>
VNS	3.1 $\pm$ 0.6 <sup>#</sup>	2.4 $\pm$ 0.7 <sup>#</sup>	1.4 $\pm$ 0.35 <sup>#</sup>	9.2 $\pm$ 2.9 <sup>#</sup>
PNU	3.5 $\pm$ 0.5 <sup>#</sup>	2.3 $\pm$ 0.51 <sup>#</sup>	1.5 $\pm$ 0.5 <sup>#</sup>	13.55 $\pm$ 2.0 <sup>#</sup>
VX	8.7 $\pm$ 1.0	6.5 $\pm$ 0.74	3.9 $\pm$ 0.97	24.3 $\pm$ 3.8
$\alpha$ -BGT	8.2 $\pm$ 1.13	6.8 $\pm$ 0.62	4.4 $\pm$ 0.65	22.13 $\pm$ 4.2

The content of TNF- $\alpha$  in plasma was expressed as ng/mL, and in intestine, lung, and liver expressed as pg/mg protein in rats. Number versus IR group,  $P < 0.05$ .

for 30 minutes, and chemiluminescence detection was performed by using SuperECL Plus (Applygen Technologies Inc., Beijing, China). Films were developed using a standard photographic procedure. Quantitative analysis of detected bands was carried out by densitometer scanning (ImageJ).

**2.12. Statistical Analysis.** SPSS 13.0 statistical software was used, and all results were expressed as mean  $\pm$  standard error of the mean. One-way ANOVA was used for comparison among all groups, followed by the Student-Newman-Keuls (SNK) test for comparison between two groups. Differences were considered to be statistically significant, when  $P \leq 0.05$ .

### 3. Results

**3.1. Electroacupuncture at ST36-Lowered TNF- $\alpha$  and IL-8 Levels of Intestine, Lung, Liver, and Plasma.** Tables 2 and 3 illustrate the effect of electroacupuncture at ST36 on TNF- $\alpha$  and IL-8 levels of intestine, lung, liver, and plasma. Intestinal I/R injury causes an inflammatory response in local intestine and remote organs. The levels of TNF- $\alpha$  in plasma and tissues of intestine, lung, and liver in the EA group were significantly lower than those in the IR group 60 min after I/R ( $P < 0.05$ ), while the levels of TNF- $\alpha$  in animals that received electroacupuncture after vagotomy or  $\alpha$ -BGT injection were not statistically different from those in the IR group. The TNF- $\alpha$  in VNS and PNU groups were obviously lower than those in the IR group ( $P < 0.05$ ). Similarly, the levels of IL-8 in plasma and tissues of intestine, lung, and liver in the EA group were significantly lower than those in the IR group ( $P < 0.05$ ). The elevation of IL-8 concentrations was significantly inhibited in rats having received vagus nerve stimulation and PNU282987 administration compared with that of IR group ( $P < 0.05$ ). However, there was no statistically significant difference in the levels of IL-8 among the VX,  $\alpha$ -BGT, and IR group.

**3.2. Electroacupuncture at ST36 Prevented Intestinal Injury.** Sections of the distal ileum from animals in the IR group were compared with those that underwent electroacupuncture at ST36 with or without abdominal vagotomy, administration of  $\alpha$ -BGT, vagal nerve stimulation, and administration of

TABLE 3: The effects of EA at ST36 on the levels of IL-8 in plasma, intestine, lung, and liver in rats with I/R injury (mean  $\pm$  SD,  $n = 12$ ).

Groups	IL-8			
	Intestine	Lung	Liver	Plasma
IR	13.62 $\pm$ 3.08	7.70 $\pm$ 1.55	5.93 $\pm$ 0.91	24.02 $\pm$ 5.53
EA	5.41 $\pm$ 1.71 <sup>#</sup>	3.68 $\pm$ 0.96 <sup>#</sup>	3.34 $\pm$ 0.56 <sup>#</sup>	10.43 $\pm$ 3.04 <sup>#</sup>
VNS	4.02 $\pm$ 0.88 <sup>#</sup>	3.53 $\pm$ 0.52 <sup>#</sup>	3.24 $\pm$ 0.53 <sup>#</sup>	9.78 $\pm$ 2.06 <sup>#</sup>
PNU	5.22 $\pm$ 1.64 <sup>#</sup>	4.38 $\pm$ 1.5 <sup>#</sup>	3.44 $\pm$ 0.39 <sup>#</sup>	13.11 $\pm$ 5.09 <sup>#</sup>
VX	13.76 $\pm$ 2.93	7.56 $\pm$ 1.5	5.14 $\pm$ 1.13	36.24 $\pm$ 4.36 <sup>#</sup>
$\alpha$ -BGT	13.52 $\pm$ 2.63	8.0 $\pm$ 1.5	6.12 $\pm$ 0.75	31.54 $\pm$ 6.58 <sup>#</sup>

The content of IL-8 in plasma was expressed as ng/mL, and in intestine, lung, and liver expressed as pg/mg protein in rats. <sup>#</sup>versus IR group,  $P < 0.05$ .

PNU282987. Figure 1(a) demonstrates the histologic pattern observed in animals receiving only electroacupuncture at nonchannel points after ischemia with villous tip necrosis, blunting, and sloughing of villi. When electroacupuncture at ST36 was performed immediately after ischemia, there was minimal if any evidence of histologic injury (Figure 1(b)). The same normal pattern of hematoxylin and eosin staining was observed in animals that underwent VNS or PNU282987 administration immediately after ischemia (Figures 1(c), and 1(d)). In contrast, when abdominal vagotomy or administration of  $\alpha$ -BGT was performed and as such, the cholinergic anti-inflammatory neuroenteric axis was interrupted, electroacupuncture at ST36 failed to prevent the histologic changes induced by I/R injury in the gut (Figures 1(e), and 1(f)). Taken together, these data demonstrated that an intact vagus nerve was necessary for the biological effect of electroacupuncture at ST36 and  $\alpha$ 7nAChR is involved in this effect.

Gut injury scores were all increased in all six groups due to I/R injury (see Figure 2). Animals subjected to I/R injury with electroacupuncture at non-channel points had an average injury score that was significantly higher than that of EA, VNS, and PNU282987 groups ( $2.18 \pm 0.19$  versus  $0.85 \pm 0.13$ ,  $0.6 \pm 0.09$ ,  $1.1 \pm 0.23$ ;  $P < 0.05$ , resp.). Surgical abdominal vagotomy or administration of  $\alpha$ -BGT before electroacupuncture at ST36 eliminated the protective effects with results similar to animals subjected to I/R injury with electroacupuncture at non-channel points ( $2.6 \pm 0.33$ ,  $2.9 \pm 0.19$  versus  $2.18 \pm 0.19$ ;  $P < 0.05$ , resp.).

**3.3. Electroacupuncture at ST36 Lowered Intestinal Permeability.** Animals in the IR group had an increase in permeability, when compared with sham animals (data not shown). Electroacupuncture at ST36, VNS, and administration of PNU282987 all protected against increased intestinal permeability compared with IR group receiving electroacupuncture at non-channel points ( $69.65 \text{ ng/mL} \pm 8.65 \text{ ng/mL}$ ,  $56.37 \text{ ng/mL} \pm 10.95 \text{ ng/mL}$ , and  $66.84 \text{ ng/mL} \pm 11.10 \text{ ng/mL}$  versus  $225.36 \text{ ng/mL} \pm 28.12 \text{ ng/mL}$ ). However, when abdominal vagotomy or administration of  $\alpha$ -BGT was performed before reperfusion, the intestinal permeability of animals undergoing electroacupuncture at ST36 was indistinguishable from electroacupuncture at non-channel points



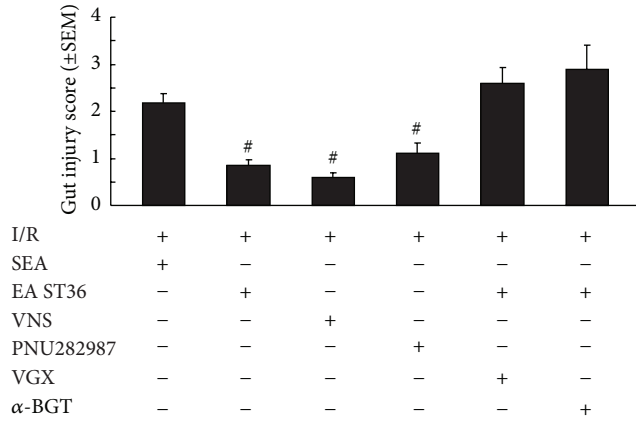

FIGURE 2: Gut injury scores at 60 min after reperfusion. Gut injury was scored by a pathologist blinded to the experimental groups on a scale of 0 to 4, from no injury to major, widespread injury with a massive inflammatory cell infiltration (Section 2). # versus IR group,  $P < 0.05$  ( $n = 12$  animals per group).

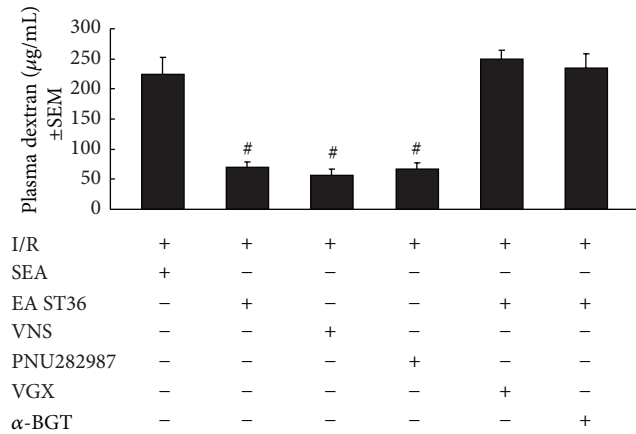

FIGURE 3: Intestinal permeability to 4-kDa FITC-dextran at 60 min after gut I/R injury. Electroacupuncture at ST36, VNS, and PNU282987 similarly protected the intestine from an increase in permeability after I/R injury, whereas abdominal vagotomy before EA ST36 eliminates such protection. The administration of  $\alpha$ -BGT before EA ST36 also eliminates such protection. # versus IR group,  $P < 0.05$  ( $n = 12$  animals per group).

(249.67 ng/mL  $\pm$  14.67 ng/mL and 234.5 ng/mL  $\pm$  23.5 ng/mL versus 225.36 ng/mL  $\pm$  28.12 ng/mL) (see Figure 3). These data indicated that electroacupuncture at ST36 can only offer protection to the gut in the presence of intact neuroenteric innervation, and electroacupuncture at ST36 might exert this effect via  $\alpha 7$ nAChR.

**3.4. Electroacupuncture at ST36 Preserves the Integrity of Intestinal Tight Junctions and Prevents Degradation of Intestinal ZO-1 Expression.** It has been found that tight junction proteins are critical structural proteins in the maintenance of mucosal barrier function [17, 18]. We used immunofluorescent staining of the tight junction protein, ZO-1, to assess the integrity of intestinal tight junctions. The tight junction

protein, ZO-1, undergoes protein expression alterations in response to I/R injury. Exposure-matched fluorescent intensity correlated to the amount of ZO-1 protein expression after immunostaining (Figure 4). After I/R injury, animals treated with electroacupuncture at nonchannel points showed a reduction in ZO-1 expression evidenced by a low fluorescent intensity at the cell periphery (Figure 4(a)). Animals treated with electroacupuncture at ST36 immediately after ischemia (Figure 4(b)) showed preservation of the robust structure of ZO-1. In contrast, in animals treated with electroacupuncture at ST36 after surgical abdominal vagotomy or administration of  $\alpha$ -BGT, no protection was afforded to the intestinal mucosa evidenced by the ready interruption and partial disappearance of ZO-1 staining at the cell periphery in villous epithelial cells (Figures 4(c) and 4(d)). Vagal nerve stimulation or IP PNU282987-treated animals had ZO-1 expression similar to EA group evidenced by a high fluorescent intensity and intense localization of ZO-1 staining at villous enterocytes (Figures 4(e) and 4(f)).

These results were confirmed by Western blotting for the ZO-1 protein in intestinal tissue lysates (Figure 5). When compared with the average relative band density of animals treated with electroacupuncture at nonchannel points after ischemia, animals treated with electroacupuncture at ST36 had significantly higher ZO-1 expression ( $P < 0.05$ ). In contrast, intestinal ZO-1 protein levels were significantly decreased in animals that underwent surgical abdominal vagotomy or administration of  $\alpha$ -BGT before electroacupuncture at ST36. Similar to electroacupuncture at ST36, vagal nerve stimulation or administration of PNU282987 after ischemia maintained a significantly higher level of ZO-1 expression compared with animals in IR group ( $P < 0.05$ ).

#### 4. Discussion

Recently, researchers have demonstrated an expanded role for vagus nerve stimulation and the parasympathetic anti-inflammatory mechanism that provides a local protective effect on the gut against epithelial barrier dysfunction [5–7]. The difficulty in translating these findings to clinical implications is that direct electrical stimulation of the vagus nerve is impractical in acutely injured patients for its complicated operation and adverse effects. Therefore, a more clinically desirable alternative therapy needs to be established, ideally an approach that has similar effects as vagus nerve stimulation and can be applied during the resuscitative phase of trauma care. In this research, the actions of electroacupuncture (EA) at ST36 acupoints in rats demonstrated protective effects on reducing local gut inflammation and intestinal barrier breakdown through activating the cholinergic anti-inflammatory-dependent mechanism and involved  $\alpha 7$ nAChR. To our knowledge, this is the first time that ZO-1 has been used in evaluating the effect of EA in preventing intestinal barrier breakdown.

In traditional Chinese medicine (TCM), an overall health is viewed as the maintenance of dynamical balance of Yin and Yang, and their imbalance can result in the development

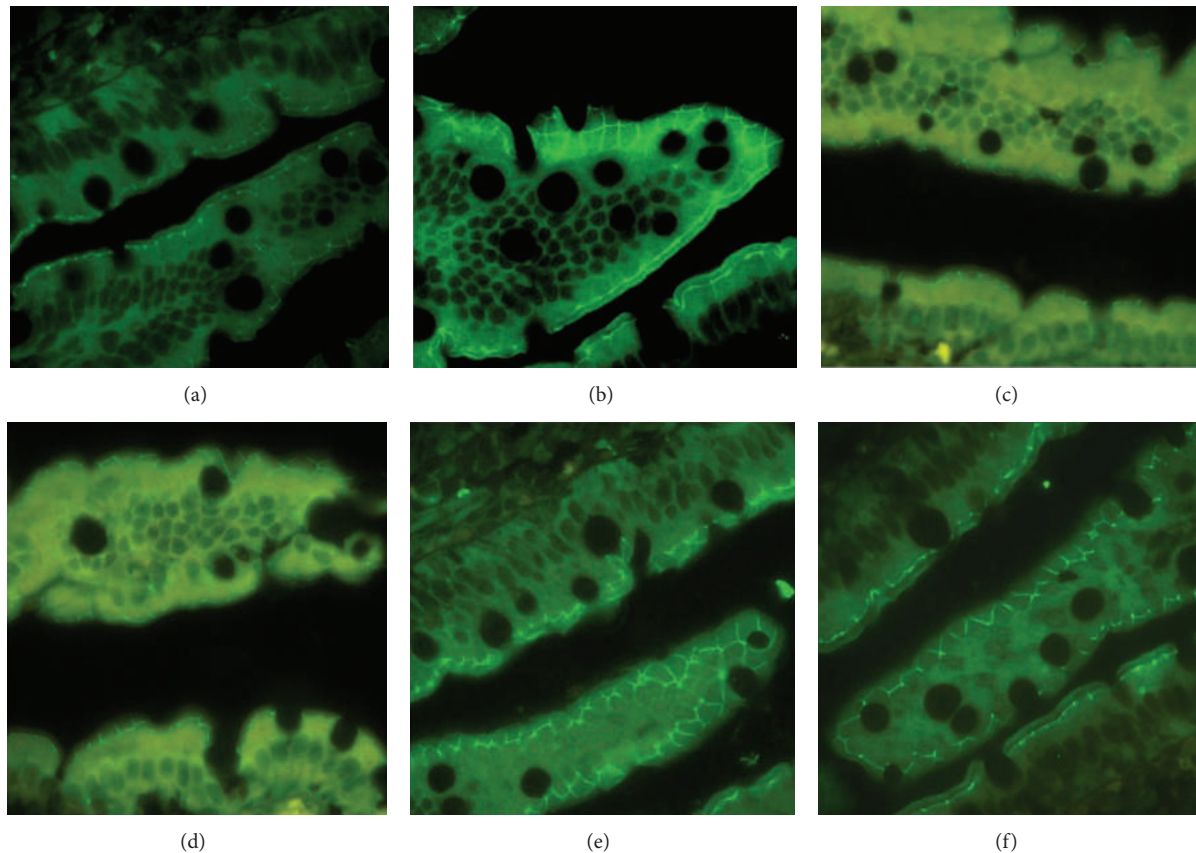

FIGURE 4: Intestinal ZO-1 immunofluorescence at 60 min after reperfusion. Animals in the IR group showed a low fluorescent intensity at the cell periphery after iI/R injury (a), and EA ST36 showed preservation of the robust structure of ZO-1 staining (b), VNS and PNU282987 similarly prevented the degeneration of ZO-1 (c and d), abdominal vagotomy or  $\alpha$ -BGT administration performed before EA ST36 eliminates the protective effect (e and f). All images are taken at  $\times 400$  magnification with black bar =  $5 \mu\text{m}$  ( $n = 12$  animals per group, size bar =  $2 \mu\text{m}$ ).

of diseases [19]. The balance of Yin and Yang is regulated by the smooth flow of “Qi”, a concept referred to as a vital force or energy in TCM that circulates between the organs along meridians. EA is one of the mostly used therapies to balance Yin and Yang by improving the flow of Qi along the meridians through stimulation of acupoints. EA is a modification of conventional acupuncture that stimulates acupoints with electrical current instead of manual manipulations and appears to have more consistently reproducible results in both clinical and research settings. EA has been clinically used to prevent and treat gastrointestinal diseases for years and can accomplish satisfying results. ST36 is a specific acupoint located on the foot Yang Ming stomach meridian and the “lower He-sea point”, which means the Qi of this meridian connects with this point, to this channel. This acupoint is known to strengthen the Qi, not only the stomach Qi, even though this acupoint belongs to the stomach meridian but also the general Qi in the whole body. ST36 is one of the most frequently used acupoints that can be stimulated through needles or “moxibustion” to balance and harmonize Yin and Yang by improving the flow of Qi along the meridians. For this reason, ST36 is the target to treat various diseases in the gastrointestinal tract as well as general symptoms in the whole body [20]. That may be an explanation of why stimulation at

ST 36 points attenuated the inflammatory action in liver and lung in this research.

Previous clinical studies have proved that acupuncture can positively affect gastrointestinal tract disorders, such as stomachache, abdominal pain and distension, constipation, diarrhea, vomiting, dysentery, indigestion, and others [21]. Animal experimental studies have showed effects of acupuncture on gastrointestinal motor dysfunction, visceral pain, gastrointestinal secretion and sensation, and gastric and intestinal motilities [22–28]. These effects seem to be relevant to vagus nerve. ST36 acupuncture has also been shown to activate the parasympathetic efferent pathway [9]. For instance, EA at ST36 promoted the gastric myoelectric activity, which was regulated by the vagus, and substance P in the dorsal vagal complex may be involved in the excitatory effects. After bilateral vagotomy, the excitatory effect was completely abolished, suggesting that it was mediated by the vagus [10]. More interestingly, increasing data indicate that stimulation at ST36 points can exhibit significant anti-inflammatory effects. ST36 acupuncture has been shown to inhibit TNF- $\alpha$  production [29], attenuate trauma-induced immunosuppression [30], and reverse sepsis-induced neutrophil migration impairment in septic rats [31]. EA at ST36 has also been proved to reduce inflammation in different

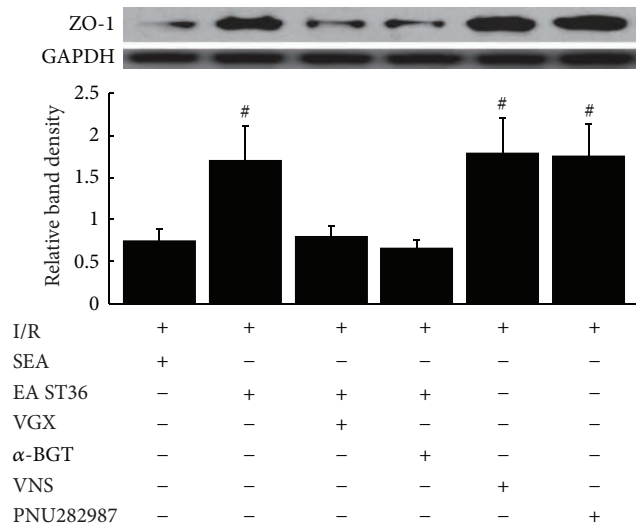

FIGURE 5: Electroacupuncture at ST36 prevents the decrease of intestinal ZO-1 protein expression. Intestinal extracts were obtained from animals 60 min following reperfusion for measurement of ZO-1 protein expression using Western blot. Representative Western blot for the ZO-1 protein is shown with its corresponding GAPDH loading control to demonstrate equal protein load in all lanes. EA ST36, VNS, and PNU282987 resulted in preservation of protein expression when performed on animals with an intact neuroenteric axis. Significant reduction in ZO-1 expression was seen after iI/R treated with SEA, and if abdominal vagotomy or  $\alpha$ -BGT was performed before EA ST36. <sup>#</sup> versus IR group,  $P < 0.05$  ( $n = 12$  animals per group).

animal models such as arthritic mice [32] and peritonitis [33]. Collectively, these data suggest the therapeutic potential of acupuncture stimulation of ST36 against gastrointestinal disorders through activation of the parasympathetic efferent pathway.

Judging from these data, we speculate that ST36 acupuncture may partly act through activating the cholinergic anti-inflammatory pathway and, most probably, through the  $\alpha 7$  subunit of nicotinic receptor to exert its anti-inflammatory effects. Because of its success in reducing inflammation, we sought to apply EA to a rat intestine ischemia and reperfusion model and determine its efficacy in reducing local gut inflammation and intestinal barrier breakdown. To our knowledge, this is the first time that ZO-1 has been used in evaluating the effect of EA in preventing intestinal barrier breakdown.

In this set of experiments, we stimulated ST36 points during ischemia, established its efficacy, and compared its effects with direct VNS and PNU282987 administering. We demonstrated that EA at ST36 points is as effective as VNS in preventing intestinal barrier breakdown after an ischemia and reperfusion insult. Furthermore, we have shown, as a proof of concept, that its biological effect is dependent on an intact vagus nerve and perhaps involves  $\alpha 7$ nAChR.

In our previous studies, we did a lot of work on the effects of EA at ST36 and also proved that it can alleviate intestinal proinflammatory factors, tissue edema, and insult

of intestinal mucosa [34], significantly protect tumor necrosis factor- $\alpha$  induced-multiple organ dysfunction in rats with sepsis [35], and have significant effects on promoting gastric emptying in rats with 40% blood volume loss [36]. Data from this study also demonstrated that ST36 acupuncture significantly attenuated the expression of cytokine in both local and remote tissues. These data suggest the anti-inflammatory potential of the use of ST36 acupuncture against intestine ischemia and reperfusion insult. Ischemia and reperfusion insult can lead to increased local production of cytokines and further induce entry of these products into the systemic circulation and distant organs. Electrical stimulation of ST36 in rats with ischemia and reperfusion injury significantly blunted local gut cytokine levels, reduced the circulating serum levels of TNF- $\alpha$  and IL-8, decreased distant lung and liver levels of TNF- $\alpha$  and IL-8, which conduce to prevent SIRS or MODS. Sham acupuncturing or the vagotomy groups increased the production of TNF- $\alpha$  and IL-8, which suggested that the anti-inflammatory effect of EA may arise through the vagal nerves, and their integrity was essential.

EA at ST36 points effectively prevented histologic injury of the gut mucosa and maintained intestinal tight junction protein expression and function. Its protective effects were eliminated by disrupting the neuroenteric axis via surgical abdominal vagotomy or partly reversed by  $\alpha 7$ nAChR antagonist  $\alpha$ -bungarotoxin.

In these experiments, EA at ST36 points successfully maintained low gut injury scores after intestine ischemia and reperfusion, reduced permeability of the distal ileum to 4-kDa FITC-dextran, and maintained normal expression of the tight junction protein ZO-1. We also proved that this biological effect is dependent on an intact vagus nerve. Disrupting the neuroenteric axis via surgical abdominal vagotomy abolished any protective effect of EA at ST36 points.

In summary, data from this study would demonstrate that, for the first time, EA at ST36 points located on a meridian, had protection effects against intestinal barrier dysfunction similar to that seen after VNS or administration of  $\alpha 7$ nAChR agonist. These preclinical animal studies demonstrate that in addition to the use of specific cholinergic agonists or vagus nerve stimulation, EA could be a potential therapeutic asset in the treatment of the severely injured patients with inflammatory diseases. Moreover, it demonstrated that a noninvasive method of transcutaneous EA at ST36 points, which has shown to limit inflammatory responses and improve outcomes, is feasible in clinic and can have major clinical implications. We think that this new data presented here should lead to further study focusing on the effects of EA at ST36 points.

## Authors' Contribution

Sen Hu and Ming-Hua Du contributed equally to this study.

## Conflict of Interests

No conflict of interests was declared.

## Acknowledgments

This study was supported by the National Basic Research Program of China (973 Program, Grant 2012CB518101). The scientific investigations were supported by the Stronach Medical Group, the German Academy of Acupuncture (DAA), and the Science Department of the City of Graz. The study is also supported by the Austrian Federal Ministries of Science and Research and of Health and the Eurasia-Pacific Uninet. Professor Litscher and Professor Wang are Visiting Professors at the Department of Acupuncture of the People's Liberation Army General Hospital, Beijing.

## References

- [1] F. A. Moore, "The role of the gastrointestinal tract in postinjury multiple organ failure," *The American Journal of Surgery*, vol. 178, no. 6, pp. 449–453, 1999.
- [2] H. T. Hassoun, B. C. Kone, D. W. Mercer, F. G. Moody, N. W. Weisbrodt, and F. A. Moore, "Post-injury multiple organ failure: the role of the gut," *Shock*, vol. 15, no. 1, pp. 1–10, 2001.
- [3] A. Stallion, T. D. Kou, S. Q. Latifi et al., "Ischemia/reperfusion: a clinically relevant model of intestinal injury yielding systemic inflammation," *Journal of Pediatric Surgery*, vol. 40, no. 3, pp. 470–477, 2005.
- [4] W. L. Biffl and E. E. Moore, "Splanchnic ischaemia/reperfusion and multiple organ failure," *The British Journal of Anaesthesia*, vol. 77, no. 1, pp. 59–70, 1996.
- [5] T. W. Costantini, V. Bansal, C. Y. Peterson et al., "Efferent vagal nerve stimulation attenuates gut barrier injury after burn: modulation of intestinal occludin expression," *Journal of Trauma—Injury, Infection and Critical Care*, vol. 68, no. 6, pp. 1349–1356, 2010.
- [6] T. W. Costantini, V. Bansal, M. Krzyzaniak et al., "Vagal nerve stimulation protects against burn-induced intestinal injury through activation of enteric glia cells," *The American Journal of Physiology*, vol. 299, no. 6, pp. G1308–G1318, 2010.
- [7] M. Krzyzaniak, C. Peterson, W. Loomis et al., "Postinjury vagal nerve stimulation protects against intestinal epithelial barrier breakdown," *Journal of Trauma—Injury, Infection and Critical Care*, vol. 70, no. 5, pp. 1168–1176, 2011.
- [8] M. J. Krzyzaniak, C. Y. Peterson, G. Cheadle et al., "Efferent vagal nerve stimulation attenuates acute lung injury following burn: the importance of the gut-lung axis," *Surgery*, vol. 150, no. 3, pp. 379–389, 2011.
- [9] M. Iwa, M. Matsushima, Y. Nakade, T. N. Pappas, M. Fujimiya, and T. Takahashi, "Electroacupuncture at ST-36 accelerates colonic motility and transit in freely moving conscious rats," *The American Journal of Physiology*, vol. 290, no. 2, pp. G285–G292, 2006.
- [10] J. H. Liu, J. Yan, S. X. Yi, X. R. Chang, Y. P. Lin, and J. M. Hu, "Effects of electroacupuncture on gastric myoelectric activity and substance P in the dorsal vagal complex of rats," *Neuroscience Letters*, vol. 356, no. 2, pp. 99–102, 2004.
- [11] V. Senna-Fernandes, D. L. M. França, D. de Souza et al., "Acupuncture at "zusanli" (St.36) and "sanyinjiao" (SP.6) points on the gastrointestinal tract: a study of the bioavailability of <sup>99m</sup>Tc-sodium pertechnetate in rats," *Evidence-Based Complementary and Alternative Medicine*, vol. 2011, Article ID 823941, 6 pages, 2011.
- [12] X. F. Ye, J. G. Li, Z. Du, Z. Q. Peng, Q. Zhou, and B. H. Jia, "Effect of electroacupuncture at "Zusanli" (ST 36) on vagal electrical activity in the rat," *Acupuncture Research*, vol. 31, no. 5, pp. 290–293, 2006.
- [13] R. A. Kozar, J. B. Holcomb, H. T. Hassoun, J. Macaitis, R. DeSoignie, and F. A. Moore, "Superior mesenteric artery occlusion models shock-induced gut ischemia-reperfusion," *Journal of Surgical Research*, vol. 116, no. 1, pp. 145–150, 2004.
- [14] W. Gao, Y. X. Huang, H. Chen, D. Y. Song, and Q. L. Wang, "Regulatory effects of electro-acupuncture at Zusanli on ir-SP content in rat pituitary gland and peripheral blood and their immunity," *World Journal of Gastroenterology*, vol. 6, no. 4, pp. 581–584, 2000.
- [15] Z. Gao, M. H. Müller, M. Karpitschka et al., "Role of the vagus nerve on the development of postoperative ileus," *Langenbeck's Archives of Surgery*, vol. 395, no. 4, pp. 407–411, 2010.
- [16] V. Bansal, T. Costantini, L. Kroll et al., "Traumatic brain injury and intestinal dysfunction: uncovering the neuro-enteric axis," *Journal of Neurotrauma*, vol. 26, no. 8, pp. 1353–1359, 2009.
- [17] G. Samak, T. Suzuki, A. Bhargava, and R. K. Rao, "c-Jun NH2-terminal kinase-2 mediates osmotic stress-induced tight junction disruption in the intestinal epithelium," *The American Journal of Physiology*, vol. 299, no. 3, pp. G572–G584, 2010.
- [18] M. C. Strauman, J. M. Harper, S. M. Harrington, E. J. Boll, and J. P. Nataro, "Enterococcal *Escherichia coli* disrupts epithelial cell tight junctions," *Infection and Immunity*, vol. 78, no. 11, pp. 4958–4964, 2010.
- [19] C. H. Yang, B. H. Lee, and S. H. Sohn, "A possible mechanism underlying the effectiveness of acupuncture in the treatment of drug addiction," *Evidence-Based Complementary and Alternative Medicine*, vol. 5, no. 3, pp. 257–266, 2008.
- [20] J. Yin and J. D. Chen, "Gastrointestinal motility disorders and acupuncture," *Autonomic Neuroscience*, vol. 157, no. 1–2, pp. 31–37, 2010.
- [21] Y. Li, G. Tougas, S. G. Chiverton, and R. H. Hunt, "The effect of acupuncture on gastrointestinal function and disorders," *The American Journal of Gastroenterology*, vol. 87, no. 10, pp. 1372–1381, 1992.
- [22] C. S. Chang, J. W. Chou, C. W. Ko, C. Y. Wu, and G. H. Chen, "Cutaneous electrical stimulation of acupuncture points may enhance gastric myoelectrical regularity," *Digestion*, vol. 66, no. 2, pp. 106–111, 2002.
- [23] M. Choi, J. Jung, M. Seo et al., "Ultrasonographic observation of intestinal motility of dogs after acupunctural stimulation on acupoints ST-36 and BL-27," *Journal of Veterinary Science*, vol. 2, no. 3, pp. 221–226, 2001.
- [24] G. C. M. Sugai, A. de O. Freire, A. Tabosa, Y. Yamamura, S. Tufik, and L. E. A. M. Mello, "Serotonin involvement in the electroacupuncture- and moxibustion-induced gastric emptying in rats," *Physiology and Behavior*, vol. 82, no. 5, pp. 855–861, 2004.
- [25] A. Tabosa, Y. Yamamura, E. R. Forno, and L. E. A. M. Mello, "Effect of the acupoints ST-36 (Zusanli) and SP-6 (Sanyinjiao) on intestinal myoelectric activity of Wistar rats," *Brazilian Journal of Medical and Biological Research*, vol. 35, no. 6, pp. 731–739, 2002.
- [26] H. Ouyang, J. Yin, Z. Wang, P. J. Pasricha, and J. D. Chen, "Electroacupuncture accelerates gastric emptying in association with changes in vagal activity," *The American Journal of Physiology*, vol. 28, no. 2, pp. G390–G396, 2002.
- [27] J. Chen, G. Q. Song, J. Yin, T. Koothan, and J. D. Z. Chen, "Electroacupuncture improves impaired gastric motility and

- slow waves induced by rectal distension in dogs," *The American Journal of Physiology*, vol. 295, no. 3, pp. G614–G620, 2008.
- [28] H. Ouyang and J. D. Chen, "Review article: therapeutic roles of acupuncture in functional gastrointestinal disorders," *Alimentary Pharmacology and Therapeutics*, vol. 20, no. 8, pp. 831–841, 2004.
- [29] L. Tian, Y. X. Huang, M. Tian, W. Gao, and Q. Chang, "Downregulation of electroacupuncture at ST36 on TNF- $\alpha$  in rats with ulcerative colitis," *World Journal of Gastroenterology*, vol. 9, no. 5, pp. 1028–1033, 2003.
- [30] L. N. Du, J. W. Jiang, G. C. Wu, and X. D. Cao, "Naloxone and electroacupuncture (EA) improve the immune function of traumatized rats," *Sheng Li Xue Bao*, vol. 50, no. 6, pp. 636–642, 1998.
- [31] M. V. R. Scognamillo-Szabó, G. H. Bechara, S. H. Ferreira, and F. Q. Cunha, "Effect of various acupuncture treatment protocols upon sepsis in wistar rats," *Annals of the New York Academy of Sciences*, vol. 1026, pp. 251–256, 2004.
- [32] Y. K. Yim, H. Lee, K. E. Hong et al., "Electro-acupuncture at acupoint ST36 reduces inflammation and regulates immune activity in collagen-induced arthritic mice," *Evidence-Based Complementary and Alternative Medicine*, vol. 4, no. 1, pp. 51–57, 2007.
- [33] M. D. da Silva, G. Guginski, M. F. de Paula Werner, C. H. Baggio, R. Marcon, and A. R. S. Santos, "Involvement of interleukin-10 in the anti-inflammatory effect of Sanyinjiao (SP6) acupuncture in a mouse model of peritonitis," *Evidence-Based Complementary and Alternative Medicine*, vol. 2011, Article ID 217946, 9 pages, 2011.
- [34] S. Hu, L. J. Zhang, H. Y. Bai, and C. M. Bao, "The effects of electro-acupuncturing at Zusanli point on intestinal proinflammatory factors, diamine oxidase and tissue water content in rats with sepsis," *Zhongguo Wei Zhong Bing Ji Jiu Yi Xue*, vol. 21, no. 8, pp. 485–487, 2009 (Chinese).
- [35] S. Hu, L. J. Zhang, H. Y. Bai, and Y. J. Tian, "Effect of electro-acupuncture at Zusanli point on tumor necrosis factor- $\alpha$  induced-multiple organ dysfunction in rats with sepsis," *Chinese Journal of Pathophysiology*, vol. 26, no. 2, pp. 353–356, 2010 (Chinese).
- [36] L. J. Zhang, S. Hu, J. Y. Hou, G. Y. Zhou, X. Shi, and Z. Y. Sheng, "Effect of electro-acupuncture at Zusanli points on gastric emptying and plasma contents of NO and MTL during oral fluid resuscitation of hemorrhagic shock in rats with blood volume loss," *World Chinese Journal of Digestology*, vol. 17, no. 4, pp. 395–398, 2009 (Chinese).

## Research Article

# Acupressure at the Meridian Acupoint Xiyangguan (GB33) Influences Near-Infrared Spectroscopic Parameters (Regional Oxygen Saturation) in Deeper Tissue of the Knee in Healthy Volunteers

Gerhard Litscher,<sup>1,2</sup> Michael Ofner,<sup>3</sup> Wei He,<sup>1,2</sup> Lu Wang,<sup>1</sup> and Ingrid Gaischek<sup>1</sup>

<sup>1</sup> Stronach Research Unit for Complementary and Integrative Laser Medicine, Research Unit of Biomedical Engineering in Anesthesia and Intensive Care Medicine and TCM Research Center Graz, Medical University of Graz, Auenbruggerplatz 29, 8036 Graz, Austria

<sup>2</sup> Department of Meridians, Institute of Acupuncture and Moxibustion, China Academy of Chinese Medical Sciences, Beijing 100700, China

<sup>3</sup> Department of Sports Physiology, University of Vienna, 1150 Vienna, Austria

Correspondence should be addressed to Gerhard Litscher; [gerhard.litscher@medunigraz.at](mailto:gerhard.litscher@medunigraz.at)

Received 21 December 2012; Accepted 7 January 2013

Academic Editor: Weibo Zhang

Copyright © 2013 Gerhard Litscher et al. This is an open access article distributed under the Creative Commons Attribution License, which permits unrestricted use, distribution, and reproduction in any medium, provided the original work is properly cited.

Up to now, it is still unknown whether microcirculation of deeper peripheral tissue (knee) can be modulated by acupuncture or acupressure on a meridian acupoint. The goal of this pilot study was to investigate possible effects of acupressure at the Xiyangguan acupoint (GB33) on the regional oxygen saturation of the deeper knee tissues by near-infrared spectroscopy (NIRS). Twelve healthy volunteers with a mean age of  $23.8 \pm 1.6$  years were investigated. Acupressure stimulation was performed for 5 minutes at the Xiyangguan acupoint. The results of the controlled study showed a significant increase of the values of regional oxygen saturation on the stimulated side of the knee ( $P = 0.033$ ), whereas the opposite side on the same knee showed insignificant changes. These results may serve as a valuable basis for monitoring a possible therapeutic effect (e.g., after Khalifa therapy) in patients with knee problems.

## 1. Introduction

As one of the complementary and alternative treatments (CAMs), acupuncture or acupressure has been utilized to improve health in Asia and Western countries. Although the mechanism of acupuncture remains still unknown in detail, acupuncture stimulation was confirmed to increase the blood flow velocity of the peripheral arterioles [1]. Up to now, studies have shown that the blood circulation of the body surface can be modulated by acupuncture or acupressure [2, 3]. But it is still unknown whether the microcirculation of the

deeper peripheral tissue can be modulated by acupuncture or acupressure.

Near-infrared spectroscopy (NIRS) is a spectroscopic method that uses the near-infrared region of the electromagnetic spectrum (from about 800 nm to 2500 nm). Medical applications of NIRS center on the noninvasive measurement of the amount and oxygen content of hemoglobin [4]. The advantage of NIRS is that it can typically penetrate much deeper into a sample than mid-infrared radiation [5].

Acupressure treatment normally uses fingertips, rather than needles, to stimulate acupoints on the skin and has been



FIGURE 1: Measurement site with applied sensors during acupressure stimulation.

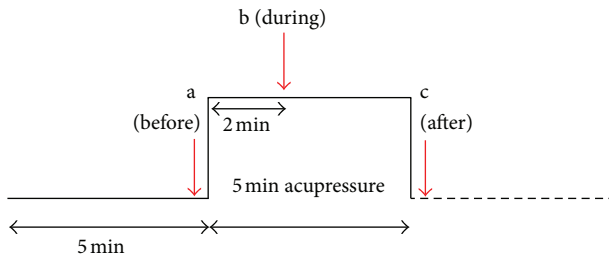

FIGURE 2: Measurement profile of the volunteer study. The measurement points are indicated (a–c).

shown to be a successful treatment for a variety of medical disorders.

The goal of the present pilot study was to investigate possible effects of acupressure at the Xiyangguan acupoint (GB33) on the regional oxygen saturation of the knee tissues at a depth of 2–4 cm, by using NIRS.

## 2. Materials and Methods

**2.1. Healthy Volunteers.** Twelve healthy volunteers (5 females, 7 males) with a mean age  $\pm$  SD of  $23.8 \pm 1.6$  years were investigated at the Medical University of Graz. None of the subjects had any neurological or cardiovascular disorders, and none of them was taking any medication. They were informed about the nature of the investigation and were paid for their participation. The study was approved by the local ethics committee, and all participants provided written informed consent.

**2.2. Acupressure.** Acupressure stimulation was performed at the Xiyangguan (GB33) acupoint. This point is located on the lateral side of the knee, 3 cun (*cun* is a relative body measure; 1 cun corresponds to the breadth of the distal phalanx of the thumb) directly proximal to Yanglingquan (GB34), at the depression superior to the lateral epicondyle of the femur, between the femur and the tendon of biceps femoris. Stimulation of Xiyangguan is indicated in cases of swelling

and pain in the knee caused by inflammatory processes [6]. To assess the reliability and validity of acupressure, pressure was applied by the same Chinese medical doctor experienced in Traditional Chinese Medicine (TCM). The thumb pressure was steady and estimated to be about  $3 \times 10^5$  Pa (mean force measured  $\sim 30$  N/cm<sup>2</sup>), as described in [7].

**2.3. Evaluation Parameters.** For the measurement of the regional oxygen saturation (rSO<sub>2</sub>), a two-channel INVOS 5100 Oximeter (Somanetics Corp., Troy, USA) was used. The principle of this system is based on NIRS technology, which is a noninvasive method for measuring regional oxygenation through the intact skin, which has been applied successfully in research and numerous clinical indications for many years [8]. Near-infrared light (730 and 805 nm) is emitted through the skin and after passing different kinds of tissue (muscle and bone) the returned light is detected at two distances from the light source (3 and 4 cm). Based upon this principle, the spectral absorption of blood in deeper structures (2–4 cm) can be determined and defined as rSO<sub>2</sub>. Before starting the measurement, the skin was cleaned with the enclosed skin-prep pad. Then two sensors were applied below the right and left lateral sides of the patella of the right leg (see Figure 1). To minimize external light influence, the knee was covered with a black cloth during the recording and stimulation procedure. After a resting time of five minutes, the rSO<sub>2</sub> data were recorded.

**2.4. Procedure.** The persons were investigated in a supine position. Acupressure started after a 5-minute resting phase. The measurement profile is shown in Figure 2. Three measurement points were evaluated (a, immediately before starting the stimulation; b, 2 min after starting the stimulation; and c, immediately after the end of the 5-minute stimulation period).

The study was performed as a controlled study. The parameter rSO<sub>2</sub> was measured at two different locations at the stimulated knee. Location 1 (acupressure side) was in a distance of 2 cm from the acupuncture point Xiyangguan (comp. Figure 1). Location 2 (serving as control) was on the same knee, on the opposite side of the patella. We did not measure the results of other acupuncture points within this study.

**2.5. Statistical Analysis.** The rSO<sub>2</sub> values of both the acupressure and the opposite side were tested with one way repeated measures ANOVA (SigmaPlot 12.0, Systat Software Inc., Chicago, USA). The Holm-Sidak method was used for post-hoc analysis. The level of significance was defined as  $P < 0.05$ .

## 3. Results

All subjects completed the study, and the measurements could be performed without any technical problems. Stimulation was perceived as painless and not discomforting. Figure 3(a) shows the increase of the rSO<sub>2</sub> values during and

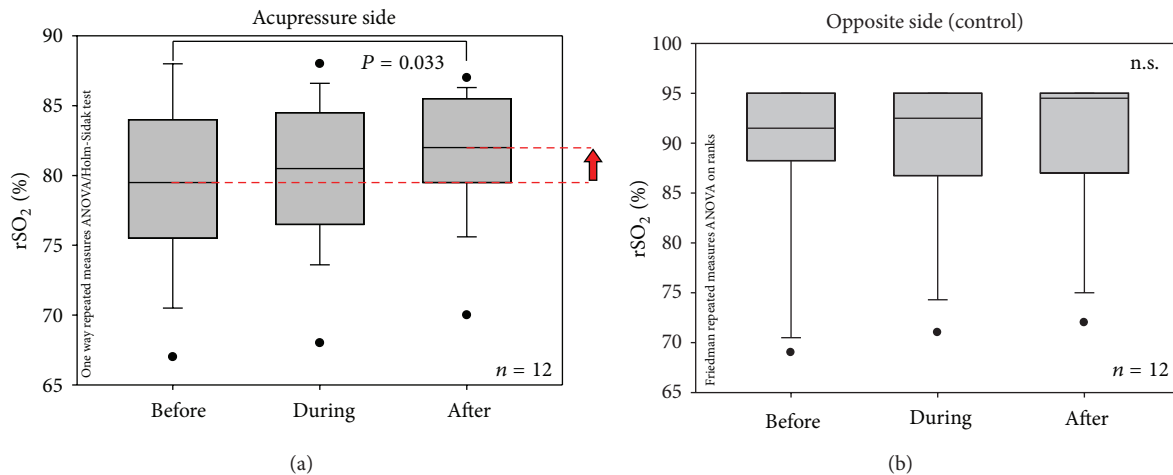

FIGURE 3: (a) Box plot presentation of changes of regional oxygen saturation values in 12 healthy volunteers before, during, and after acupressure (comp. Figure 2) on the stimulated side (acupressure side). Note the significant increase immediately after the 5-minute acupressure phase; the median of the rSO<sub>2</sub> was increased by 2.5% compared to baseline values. The ends of the boxes define the 25th and 75th percentiles with a line at the median, and error bars defining the 10th and 90th percentiles. (b) Box plot presentation of changes of regional oxygen saturation values in 12 healthy volunteers before, during, and after acupressure (comp. Figure 2) on the opposite (control) side. For further explanations, see Figure 3(a).

after acupressure being applied to the acupoint Xiyangguan in all 12 healthy volunteers.

The values of rSO<sub>2</sub> of the opposite side are presented in Figure 3(b). No statistically significant differences were found on this side, although the median was increased during and after acupressure.

#### 4. Discussion

Acupressure is a noninvasive strategy used to manage multiple symptoms in a variety of patient populations [9], including relieving pain [10], managing nausea and vomiting [11], and many other applications.

The acupuncture point Xiyangguan (GB33) is located on the gall bladder meridian. This meridian runs along the lateral aspect of the thigh and knee, going further downward along the anterior border of the fibula. As mentioned in the methods section, GB33 is located lateral to the knee joint. It is a conventional acupoint in the treatment of knee osteoarthritis [12]. In the present study, the oxygen saturation of a healthy knee could be affected by acupressure at GB33 in a depth of 2–4 cm. Our results are in accordance with the meridian theory, which states that firstly, the area along the meridian will be affected by stimulating acupoints on the meridian, and secondly, the function of local tissues can be affected by stimulating nearby acupoints [13].

In recent years, we have investigated the relationship between acupuncture and cerebral microcirculation using NIRS. In three healthy male volunteers, acupuncture at specific acupuncture points led to an increase in oxygenated hemoglobin and in the tissue oxygenation index. However, needling and laser puncture at placebo points did not produce

the same effect on cerebral oxygenation [14]. In 16 adult volunteers, a significant decrease was found in oxyhemoglobin after needle insertion and stimulation, accompanied by an increase in deoxyhemoglobin [15]. The results suggest that NIRS technology may be useful in visualizing and quantifying the cerebral vascular effects of acupuncture and acupuncture-like stimulation on microcirculation [16].

The primary application of NIRS to the human body uses the fact that the transmission and absorption of NIR light in human body tissues contains information about hemoglobin concentration changes. NIRS can be used to quantify blood flow, blood volume, oxygen consumption, reoxygenation rates, and muscle recovery time [17]. In comparison with laser Doppler flowmetry (LDF), NIRS can typically penetrate much deeper into a sample. NIRS can penetrate the tissue in a depth of 2–4 cm, whereas LDF can only penetrate the tissue in a depth of about 1–3 mm. NIRS is more sensitive than LDF with regard to detecting changes in tissue inflow [18]. Besides, NIRS systems are usually portable, even wireless instrumentation is available, which enables investigations in freely moving subjects [19]. It has also been suggested as a method for arthroscopic evaluation of low grade degenerated cartilage lesions [20].

To the best of our knowledge, this is the first study which evaluates the effects of acupressure on the regional blood oxygenation of the knee tissues using NIRS.

Studies have investigated the mechanism of acupuncture or acupressure with respect to peripheral microcirculation. The blood flow velocity was found to be increased after continuous digital acupressure. It has also been suggested that cyclic Guanosine Monophosphate (cGMP) mediates the signaling functions of nitric oxide (NO) to improve local microcirculation [21]. A neurovascular transmission model



for the acupuncture-induced NO effect has been proposed by Hsiao and Tsai [22]. In this model, the acupuncture stimulus is able to influence connective tissue via mechanical force transfer to the extracellular matrix (ECM). Through the ECM, the mechanotransduction stimulus can be translated or travel from the acupuncture points including local tissue and cells. Cells in the local tissue that have received mechanotransduction induce different types of NO production to induce changes in blood flow and local circulation [22]. By assessing the responses of arteriolar blood flow to acupuncture stimulation in rabbits, it was found that the arteriolar diameter significantly increased to  $131\% \pm 14\%$  in the acupuncture group when compared with the pretreatment value. Blood flow velocity and blood flow rate showed similar trends. The treatment effect remained manifest for 40–50 min after the end of stimulation and irradiation [23].

Our preliminary study has some limitations. We did not measure environmental temperature which could possibly also affect the results, but this is not very probable. It is also possible that the articular cavity can influence the measurement results, and this could also be a reason for the variation among the subjects before the procedure. Moreover, the informative value of our results may be compromised by the fact that already baseline values differ strongly between the acupressure side and the opposite (control) side, being much higher on the opposite side.

Acupressure is a noninvasive therapy, which is readily accepted by people with needle phobia. It can be used similar to acupuncture, for example, in the treatment of knee osteoarthritis or other diseases related to the knee [24].

## 5. Conclusion

The following conclusion can be drawn from the present pilot study. The values of regional oxygen saturation (rSO<sub>2</sub>) on the stimulated side of the knee were significantly increased immediately after acupressure stimulation, whereas the opposite (control) side on the same knee showed insignificant changes. Further investigations with a four-channel NIRS system for measurements on both knees are in progress.

## Conflict of Interests

No conflict of interest declared.

## Authors' Contribution

G. Litscher and M. Ofner contributed equally to this study.

## Acknowledgments

The present study is a pilot study for the project “Interdisciplinary Evaluation of Acute Effects of the Khalifa Therapy in Patients with Ruptured Anterior Cruciate Ligament in the Knee” (project part: Biomedical Engineering and Analyses Focused on NIRS—Thermography and Doppler Flowmetry). The pilot study was also supported by the Stronach Medical Group, Eurasia-Pacific Uninet, the Department of Science of

the City of Graz, and Sino-Austrian research projects. It is part of the research area *Sustainable Health Research* at the Medical University of Graz.

## References

- [1] G. Litscher, “Bioengineering assessment of acupuncture—part 2: monitoring of microcirculation,” *Critical Reviews in Biomedical Engineering*, vol. 34, no. 4, pp. 273–294, 2006.
- [2] H. Hsiu, W. C. Hsu, B. H. Chen, and C. L. Hsu, “Differences in the microcirculatory effects of local skin surface contact pressure stimulation between acupoints and nonacupoints: possible relevance to acupressure,” *Physiological Measurement*, vol. 31, no. 6, pp. 829–841, 2010.
- [3] H. Hsiu, W. C. Hsu, S. L. Chang, C. L. Hsu, S. M. Huang, and Y. Y. W. Lin, “Microcirculatory effect of different skin contacting pressures around the blood pressure,” *Physiological Measurement*, vol. 29, no. 12, pp. 1421–1434, 2008.
- [4] X. Borrat Frigola, J. Mercadal Mercadal, and E. Zavala, “Near-infrared spectroscopy in the postanesthesia recovery care unit: noninvasive monitoring of peripheral perfusion,” *Revista Española de Anestesiología y Reanimación*, vol. 57, no. 6, pp. 364–373, 2010.
- [5] A. J. Fallgatter, A. C. Ehlis, A. Wagener, T. Michel, and M. J. Herrmann, “Near-infrared spectroscopy in psychiatry,” *Nervenarzt*, vol. 75, no. 9, pp. 911–916, 2004.
- [6] J. Yan, *Skills with Illustrations of Chinese Acupuncture and Moxibustion*, Hunan Science & Technology Press, Changsha, China, 2006.
- [7] G. Litscher, “Effects of acupressure, manual acupuncture and Laserneedle acupuncture on EEG bispectral index and spectral edge frequency in healthy volunteers,” *European Journal of Anaesthesiology*, vol. 21, no. 1, pp. 13–19, 2004.
- [8] G. Litscher and G. Schwarz, Eds., *Transcranial Cerebral Oximetry*, Pabst Science Publishers, Lengerich, Germany, 1997.
- [9] E. J. Lee and S. K. Frazier, “The efficacy of acupressure for symptom management: a systematic review,” *Journal of Pain and Symptom Management*, vol. 42, no. 4, pp. 589–603, 2011.
- [10] S. H. Cho and E. W. Hwang, “Acupressure for primary dysmenorrhoea: a systematic review,” *Complementary Therapies in Medicine*, vol. 18, no. 1, pp. 49–56, 2010.
- [11] J. Abraham, “Acupressure and acupuncture in preventing and managing postoperative nausea and vomiting in adults,” *Journal of Perioperative Practice*, vol. 18, no. 12, pp. 543–551, 2008.
- [12] C. R. Meng, L. Fan, W. B. Fu, and Y. Li, “Clinical research on abdominal acupuncture plus conventional acupuncture for knee osteoarthritis,” *Journal of Traditional Chinese Medicine*, vol. 29, no. 4, pp. 249–252, 2009.
- [13] G. Litscher, “Integrative laser medicine and high-tech acupuncture at the Medical University of Graz, Austria, Europe,” *Evidence-Based Complementary and Alternative Medicine*, vol. 2012, Article ID 103109, 21 pages, 2012.
- [14] G. Litscher, “Bioengineering assessment of acupuncture—part 5: cerebral near-infrared spectroscopy,” *Critical Reviews in Biomedical Engineering*, vol. 34, no. 6, pp. 439–457, 2006.
- [15] G. Litscher, L. Wang, and E. Huber, “Changes in near-infrared spectroscopic parameters during manual stimulation with acupuncture needles,” *Biomedizinische Technik*, vol. 47, no. 4, pp. 76–79, 2002.
- [16] G. Litscher and L. Wang, “Cerebral near-infrared spectroscopy and acupuncture—preliminary results,” *Biomedizinische Technik*, vol. 45, no. 7-8, pp. 215–218, 2000.

- [17] R. Boushel and C. A. Piantadosi, "Near-infrared spectroscopy for monitoring muscle oxygenation," *Acta Physiologica Scandinavica*, vol. 168, no. 4, pp. 615–622, 2000.
- [18] J. Kaneko, Y. Sugawara, Y. Matsui, H. Sakata, and N. Kokudo, "Comparison of near-infrared spectroscopy and laser doppler flowmetry for detecting decreased hepatic inflow in the porcine liver," *Journal of Investigative Surgery*, vol. 22, no. 4, pp. 268–274, 2009.
- [19] B. Shadgan, W. D. Reid, R. Gharakhanlou, L. Stothers, and A. J. MacNab, "Wireless near-infrared spectroscopy of skeletal muscle oxygenation and hemodynamics during exercise and ischemia," *Spectroscopy*, vol. 23, no. 5-6, pp. 233–241, 2009.
- [20] G. Spahn, H. Plettenberg, E. Kahl, H. M. Klinger, T. Mückley, and G. O. Hofmann, "Near-infrared (NIR) spectroscopy. A new method for arthroscopic evaluation of low grade degenerated cartilage lesions. Results of a pilot study," *BMC Musculoskeletal Disorders*, vol. 8, article 47, 2007.
- [21] N. T. Jou and S. X. Ma, "Responses of nitric oxide—cGMP release in acupuncture point to electroacupuncture in human skin in vivo using dermal microdialysis," *Microcirculation*, vol. 16, no. 5, pp. 434–443, 2009.
- [22] S. H. Hsiao and L. J. Tsai, "A neurovascular transmission model for acupuncture-induced nitric oxide," *JAMS Journal of Acupuncture and Meridian Studies*, vol. 1, no. 1, pp. 42–50, 2008.
- [23] M. Komori, K. Takada, Y. Tomizawa et al., "Microcirculatory responses to acupuncture stimulation and phototherapy," *Anesthesia and Analgesia*, vol. 108, no. 2, pp. 635–640, 2009.
- [24] G. Jamtvedt, K. T. Dahm, I. Holm, and S. Flottorp, "Measuring physiotherapy performance in patients with osteoarthritis of the knee: a prospective study," *BMC Health Services Research*, vol. 8, article 145, 2008.

## Research Article

# The Influence of Zusanli and Nonmeridian Acupuncture Points on the Survival Rate and Intestinal Tissue Features after Fatal Hemorrhagic Shock in Rats

Xian Shi,<sup>1</sup> Yuxian Zhong,<sup>2</sup> Jiarui Yao,<sup>1</sup> Sen Hu,<sup>3</sup> Lu Wang,<sup>1,4</sup> and Gerhard Litscher<sup>1,4</sup>

<sup>1</sup> Department of Acupuncture, People's Liberation Army General Hospital, 28 Fu-Xing Road, Beijing 100853, China

<sup>2</sup> Department of Rehabilitation and Physiotherapy, Navy General Hospital, Beijing 100048, China

<sup>3</sup> Laboratory of Shock and Multiple Organ Dysfunction, Burns Institute, The First Hospital Affiliated to the People's Liberation Army General Hospital, Beijing 100037, China

<sup>4</sup> Stronach Research Unit for Complementary and Integrative Laser Medicine, Research Unit of Biomedical Engineering in Anesthesia and Intensive Care Medicine and TCM Research Center Graz, Medical University of Graz, Auenbruggerplatz 29, 8036 Graz, Austria

Correspondence should be addressed to Sen Hu; [hs82080@yahoo.com.cn](mailto:hs82080@yahoo.com.cn) and Gerhard Litscher; [gerhard.litscher@medunigraz.at](mailto:gerhard.litscher@medunigraz.at)

Received 19 December 2012; Accepted 4 January 2013

Academic Editor: Weibo Zhang

Copyright © 2013 Xian Shi et al. This is an open access article distributed under the Creative Commons Attribution License, which permits unrestricted use, distribution, and reproduction in any medium, provided the original work is properly cited.

Sixty Sprague-Dawley rats were divided into 5 groups: (a) control group (HS); (b) Immediate rehydration group (IFR); (c) ST36 electroacupuncture (EA) delay rehydration group (EA/DFR): EA at ST36 immediately after blood loss with infusion 3 h later; (d) EA nonmeridian rehydration group (SEA/DFR): EA at nonacupuncture sites with rehydration similar to EA/DFR; (e) ST36 EA group (EA): EA at ST36 immediately after blood loss with no rehydration. Forty-five percent of the entire blood volume was taken out to make lethal hemorrhagic shock models. We recorded the survival rate, intestinal tissue DAO content, and microcirculation. The survival rate of the EA/DFR group and the IFR group was significantly higher than that of the other three groups ( $P < 0.05$ ). Twelve hours after blood loss, intestinal tissue DAO content of the EA/DFR group and the IFR group was significantly higher than that of the SEA/DFR group, EA group, and HS group ( $P < 0.05$  and  $P < 0.01$ ). The mucosal blood flow of the EA/DFR group and the IFR group was significantly higher than the other groups ( $P < 0.05$  each). We conclude that EA improves the blood pressure and raises the early survival rate of hemorrhagic shock rats, maintains the intestinal barrier function, and improves the degree of intestinal ischemia.

## 1. Introduction

Nowadays, accidents, wars, and disasters occur frequently. In a short period of time, there can be a batch of wounded in hypovolemic shock. Conventional antishock means (such as blood transfusion, or infusion) are difficult to implement timely. The prolonged hypoperfusion will cause damage to the intestinal mucosal barrier of the body, increase the systemic inflammatory response, and induce sepsis, which increases mortality or complications [1]. The acupoint ST36 (Zusanli) on the stomach meridian is considered to be the main point of regulation of gastrointestinal function, promoting gastrointestinal peristalsis and detoxification and protecting the mucosal barrier [2]. Therefore, we studied

the mechanism of the ST36 acupuncture point in fatal hemorrhagic shock in rats.

## 2. Materials and Methods

**2.1. Sprague-Dawley Rats.** Sixty SPF (specific pathogen free) Sprague-Dawley male adult rats (weight  $270 \pm 25$  g) were kept under constant temperature ( $24 \pm 2^\circ\text{C}$ ) and constant humidity of  $50 \pm 5\%$  for one week. They had to refrain from eating for 12 hours and were forbidden to drink for 4 hours preoperatively. The study was approved by the Institutional Animal Care and Use Committee (license number SCXK Beijing 2009/0007) and was in accordance with National

Institutes of Health guidelines. The animals were anesthetized using an intraperitoneal injection of ketamine hydrochloride and sumianxin new II (0.4 mL/kg, mixed 2 : 1 by volume).

**2.2. Monitoring and Stimulation Equipment.** For monitoring the microcirculation of intestinal tissue, we used a Laser Doppler flowmetry system (PeriFlux5000, PERIMED, Jarfälla, Sweden). The detection of diamine oxidase (DAO) was performed using kits from Nanjing Jiancheng Technology Co.; the micropump for infusions is a product of Millipore Corporation, Japan. The electroacupuncture (EA) stimulator was an INTI KWD-808I-type pulse meter from Changzhou Yingdi Electronic Medical Device, Changzhou, China.

**2.3. Experimental Procedure.** Based on the improved method described in the publication of Higashimura et al. [3], we used an animal model with 45% blood loss. The rats underwent femoral vein dissection and catheterization; femoral artery dissection and catheterization; and carotid dissection and intubation at the neck incision. Then a cardiopulmonary capacity monitor was connected to monitor mean arterial pressure (MAP). The abdominal cavity was cut open along the ventral midline about 5 cm, and laser Doppler probes were placed 10 cm from the Treitz ligament. A 1% heparin saline solution was injected into the femoral vein to make the animals systemically heparinized. After this was completed, the time was metered -0.5 h, that is, 30 min before blood loss. Then, bloodletting from the femoral artery started. First, 30% of the total blood volume was taken out at a constant rate in 15 min. Then bleeding was stopped for 5 min, before another 15% of the total blood volume was taken out at a constant rate in 10 min. So, the entire process was completed in 30 min, and the total blood volume taken out was 45%. The rat systemic estimated blood was calculated using the following formula: estimated systemic blood = weight (g)  $\times$  0.06 (mL/g) + 0.77 [3]. The completion of the hemorrhagic shock model concluded the preparation phase, and the time was metered 0.

All animals were observed at four time points before blood loss and after hemorrhagic shock: 30 min before blood loss (-0.5 h); 3 h, 12 h, and 24 h after blood loss. The rats were randomly divided into five groups (12 animals each).

- (a) Hemorrhagic shock group (HS) for control purposes; this group did not receive any intervention (acupuncture or rehydration treatment).
- (b) The immediate rehydration (IFR) group was given a femoral vein infusion with Ringer lactate (2 times the amount of blood loss) immediately after blood loss, lasting 40 min.
- (c) The electroacupuncture (EA) group received EA bilaterally at the ST36 point on the stomach meridian. EA was done immediately after blood loss; needle insertion depth 7 mm [4], stimulation for 40 minutes, frequency 4 Hz, constant voltage 4 V. The animals in this group did not receive rehydration.

(d) In the EA/DFR (delayed rehydration) group, animals were infused 3 h after blood loss; the infusion method and liquid were the same as the IFR group, and EA parameters were the same as in the EA group.

(e) The SEA/DFR group was electro-acupunctured at nonacupoints (0.5 cm lateral and distal from ST36, i.e., not on the meridian) immediately after blood loss; other interventions were the same as in the EA/DFR group.

#### 2.4. Sample Collection and Processing

(a) Index determination

- (i) The surviving rats in each group were counted 3 h, 12 h, and 24 h after blood loss for statistical analysis;
  - (ii) MAP was recorded using a cardiorespiratory monitor;
  - (iii) monitoring microcirculatory blood flow of intestinal mucosal tissue was performed with a laser Doppler probe and measured three times to obtain an average value
- (b) 100 mg of the small intestine tissue were retrieved at a distance of 5 cm from the cecum. We added 0.9 mL of 0.9% saline solution to grind, homogenize, and obtain the supernatant. A DAO kit and spectrophotometer was used to measure the activity of DAO.

**2.5. Statistical Analysis.** SPSS 17.0 statistical software was used to calculate percentages, means, and standard deviations. One-way ANOVA was used for comparison among all groups, followed by the Student-Newman-Keuls (SNK) test for comparison between two groups.  $P < 0.05$  was defined as the level of statistical significance.

### 3. Results

**3.1. Survival Rate.** The survival rate of the EA/DFR group, EA group, and IFR group was significantly higher than that of the HS group at the point of 3 h ( $P < 0.05$  each). At the point of 12 h and 24 h, the survival rate of the IFR group and the EA/DFR group was significantly higher than that of the other groups ( $P < 0.05$  each) (see Figure 1).

**3.2. Mean Arterial Blood Pressure (MAP).** MAP in each group was significantly lowered after blood loss. MAP at time 0 was only 25%-26% of that before blood loss; after 3 hours, MAP in each group increased by different degrees. MAP of the IFR group was significantly higher than that of the other groups ( $P < 0.01$  each), and MAP of the EA group and the EA/DFR group was significantly higher than that of the SEA/DFR group ( $P < 0.01$  each). After 24 h, there was no significant difference in MAP between the groups (Figure 2).

**3.3. DAO Activity Changes in Intestinal Tissue.** Three hours after blood loss, the DAO content of intestinal tissue in each group was significantly lower compared to the point before

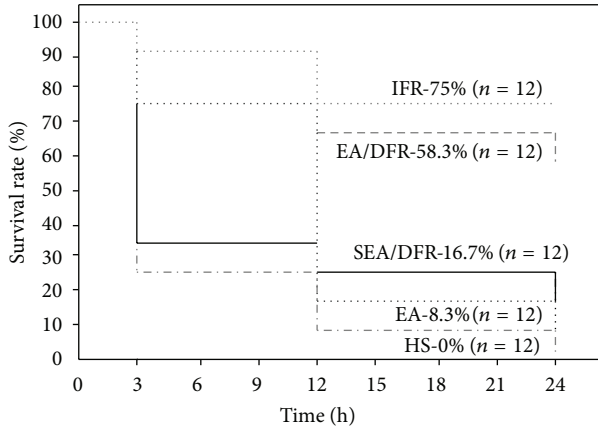

FIGURE 1: Kaplan-Meier graph of survival rate of rats in each group after 45% blood loss. *N* = 12 refers to the original number of animals in each group.

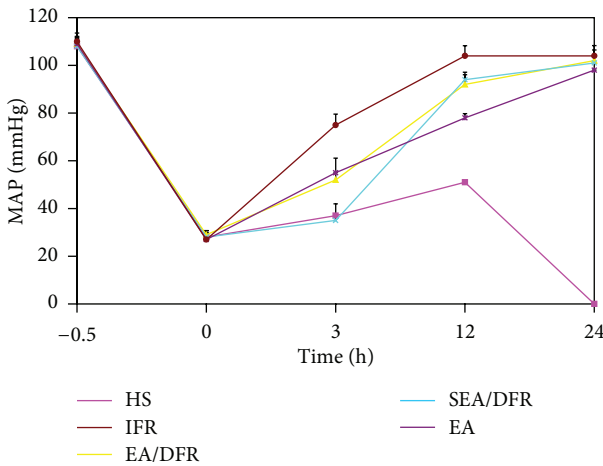

FIGURE 2: The change of MAP (mean ± SE) at different time points after blood loss.

blood loss. The activity of the IFR group was significantly higher than that of the other four groups ( $P < 0.05$  each); however, the EA/DFR group and EA group were significantly higher than the SEA/DFR group and the HS group ( $P < 0.05$  each). Twelve hours after blood loss, the IFR group was significantly higher than the other four groups ( $P < 0.05$  each), but the EA/DFR group was significantly higher than the HS group, SEA/DFR group and EA group ( $P < 0.01$  each) (see Table 1).

**3.4. Mucosal Blood Flow.** After blood loss, mucosal blood flow in each group was significantly lowered ( $P < 0.05$  each). Three hours after blood loss, the mucosal blood flow of the EA/DFR group and the EA group was lower than that of the IFR group ( $P < 0.05$ ), but significantly higher than the HS group and the SEA/DFR group ( $P < 0.05$  each). Twelve hours after blood loss, there was no significant difference between the EA/DFR group and the IFR group ( $P > 0.05$ ), but these

TABLE 1: The change of DAO activity of intestinal tissue (mean ± SD) at different time points after blood loss.

Group	<i>N</i> (originally)	DAO [U/L]		
		-0.5 h	3 h	12 h
HS	12	48.5 ± 2.7	20.1 ± 2.2 <sup>ab</sup>	—
IFR	12	49.3 ± 3.9	38.1 ± 1.6 <sup>b</sup>	44.1 ± 2.8 <sup>b</sup>
EA/DFR	12	48.8 ± 3.0	29.9 ± 4.5 <sup>a</sup>	37.9 ± 3.4 <sup>a</sup>
SEA/DFR	12	49.2 ± 1.1	20.5 ± 2.6 <sup>ab</sup>	30.3 ± 1.3 <sup>ab</sup>
EA	12	48.3 ± 1.6	28.6 ± 2.8 <sup>ab</sup>	—

Note: the comparison with IFR group, <sup>a</sup> $P < 0.05$ ; the comparison with EA/DFR group, <sup>b</sup> $P > 0.05$ . “—” means that the number of surviving animals was too small to calculate statistical values.

two groups were significantly higher than all other groups ( $P < 0.05$  each) (see Table 2).

#### 4. Discussion

In order to ensure the blood supply of the vital organs during hemorrhagic shock, a sharp reduction in the intestinal blood flow and in the intestinal mucosal functional barrier occurs under the action of the sympathetic-adrenal medullary system and vasoconstrictor substances, such as catecholamine. Hence intestinal endotoxemia and bacterial translocation act on the liver via the portal vein through the portal circulation and lymphatic system. Endotoxin can cause a lack of the nutrition bloodstream to the liver and lower the degree of mitochondrial oxygen metabolism, which may cause liver dysfunction or even liver failure. Liver dysfunction can accelerate the diffusion of endotoxin in vivo, which can lead to multiple organ dysfunction syndrome (MODS) or even death. All the processes mentioned above are important reasons which make hemorrhagic shock irreversible [1], and they are also important factors for the high mortality rate of hemorrhagic shock. Therefore, maintaining bowel function and protecting the mucosal barrier can delay the development of hemorrhagic shock and avoid the transition to septic shock; furthermore it can improve delay rehydration effect and the survival rate of patients with hemorrhagic shock [5, 6].

Our previous research [7, 8] indicates that the ST36 acupuncture point is capable of activating the cholinergic anti-inflammatory pathway, as the result of reducing the level of rats’ intestinal tissue proinflammatory cytokine and intestinal tissue edema and dysfunction.

The present study shows that the ST36 acupuncture point improves rehydration, rats’ blood pressure levels, and the subsequent rehydration treatment effect to a certain extent, which increases the survival rate of rats in hemorrhagic shock. At the same time, it shows a significant change of the DAO content of intestinal tissues after massive blood loss. DAO is an enzyme which is present in the small intestine mucosa upper villus cell in mammals. It can reflect the small intestine mucosal structure and function [9]. When hemorrhagic shock occurs, the function of the intestinal barrier is damaged, and DAO of the intestinal mucosa is released into the blood, which leads to an increase

TABLE 2: The monitoring results of changes in mucosal blood flow (mean  $\pm$  SD) in each group.

Group	N (originally)	The intestinal mucosal blood flow [perfusion unit (PU)]		
		-0.5 h	3 h	12 h
HS	12	211.3 $\pm$ 21.9	85.6 $\pm$ 11.8 <sup>ac</sup>	—
IFR	12	209.9 $\pm$ 27.1	152.8 $\pm$ 23.6	149.6 $\pm$ 10.8
EA/DFR	12	216.8 $\pm$ 50.9	116.1 $\pm$ 16.6 <sup>a</sup>	151.4 $\pm$ 21.4 <sup>b</sup>
SEA/DFR	12	212.4 $\pm$ 49.5	88.7 $\pm$ 13.1 <sup>ac</sup>	102.3 $\pm$ 27.2 <sup>ac</sup>
EA	12	212.8 $\pm$ 36.7	115.8 $\pm$ 14.2 <sup>a</sup>	—

Note: the comparison with IFR group, <sup>a</sup> $P < 0.05$ , <sup>b</sup> $P > 0.05$ ; the comparison with EA/DFR group, <sup>c</sup> $P < 0.05$ . “—” means that the number of surviving animals was too small to calculate statistical values.

of DAO activity in plasma and a decrease of DAO activity in intestinal tissue [10]. However, when acupuncture at the ST36 point, the content of DAO and the blood flow of the intestinal mucosa were significantly higher than those of the non-electroacupuncture group and the sham acupuncture group. This illustrates that the ST36 acupuncture point has a protective effect on intestinal mucosa.

In conclusion, only acupuncture at the ST36 point, located on a meridian, can improve the survival rate of rats with fatal hemorrhagic shock, which may have a direct relationship with the improvement of the intestinal barrier's function and an increase of blood flow.

## Conflict of Interests

No conflict of interests is declared.

## Acknowledgments

This research work was supported by the National Natural Science Foundation of China and the National Basic Research Program of China (973 Program). The scientific investigations were supported by the Stronach Medical Group, the German Academy of Acupuncture (DAA), and the Department of Science of the City of Graz. The study is also supported by the Austrian Federal Ministries of Science and Research and of Health and the Eurasia-Pacific Uninet. Professor Litscher and Professor Wang are Visiting Professors at the Department of Acupuncture of the People's Liberation Army General Hospital, Beijing. The authors would like to thank Ms. Ingrid Gaischek, M.S. (Stronach Research Unit for Complementary and Integrative Laser Medicine, Medical University of Graz), for her valuable help in paper and figure preparation.

## References

- [1] Z. C. Chen, *Pathophysiology*, vol. 1, People's Medical Publishing House, Beijing, China, 2005.
- [2] X. F. Ye, J. G. Li, Z. H. Li et al., “Effect of ST36 point of acupuncture on discharge of vagus nerve of rats,” *Acupuncture Research*, vol. 31, no. 5, pp. 290–293, 2006.
- [3] Y. Higashimura, R. Shimoju, H. Maruyama, and M. Kurosawa, “Electro-acupuncture improves responsiveness to insulin via

excitation of somatic afferent fibers in diabetic rats,” *Autonomic Neuroscience*, vol. 150, no. 1-2, pp. 100–103, 2009.

- [4] D. F. Mayor, Ed., *Electroacupuncture. A Practical Manual and Resource*, Churchill Livingstone, New York, NY, USA, 2007.
- [5] M. Choi, J. Jung, M. Seo et al., “Ultrasonographic observation of intestinal mobility of dogs after acupuncture stimulation on acupoints ST-36 and BL-27,” *Journal of Veterinary Science*, vol. 2, no. 3, pp. 221–226, 2011.
- [6] J. Yin, J. Chen, and J. D. Z. Chen, “Ameliorating effects and mechanisms of electroacupuncture on gastric dysrhythmia, delayed emptying, and impaired accommodation in diabetic rats,” *American Journal of Physiology*, vol. 298, no. 4, pp. G563–G570, 2010.
- [7] S. Hu, L. J. Zhang, H. Y. Bai, and C. M. Bao, “Effects of electro-acupuncture at Zusanli point on the expression of proinflammatory cytokines, the activity of diamine oxidase and the rate of water content in the small intestine in rats with sepsis,” *World Chinese Journal of Digestology*, vol. 17, no. 20, pp. 2079–2082, 2009.
- [8] X. Shi, Q. Song, S. Hu et al., “Study of acupuncture on endotoxin which can induce protective use of liver injury of rats,” *Chinese Acupuncture*, vol. 28, no. 4, pp. 290–292, 2008.
- [9] Y. J. Sun, H. J. Cao, Q. Jin, Y. G. Diao, and T. Z. Zhang, “Effects of penehyclidine hydrochloride on rat intestinal barrier function during cardiopulmonary bypass,” *World Journal of Gastroenterology*, vol. 17, no. 16, pp. 2137–2142, 2011.
- [10] J. Y. Li, Y. Lv, S. Hu et al., “Experimental study on monitoring of barrier function of small intestine,” *Journal of Traumatic Surgery*, vol. 3, no. 2, pp. 109–110, 2001.